

TABLE OF CONTENTS

22 MEDITATIONS on the SEPHER YETZIRAH

A CHRISTIAN PATH IN SPIRITUAL GEOMETRY

"MICHAEL // SOPHIA IN NOMINE CHRISTI"

A PIC OF OUR WORK ON THE 22 ROSICRUCIAN SPHERES

THE TEXT FOLLOWS HERE:

CHAPTER ONE - THE CELESTIAL TETRAHEDRON

CHAPTER TWO - THE LAW OF SEVEN

1. **Septenary in Nature**
2. **Septenary in Man**
3. **Septenary in the Ages and Epochs of Man**
 - -Astronomical Ages
 - -Cultural Epochs
 - -The Saturn Cycle
4. **Septenary in Religion**
 - -The Lemniscate of Religion
 - -7 Cultural Epochs
 - -**Asian war**
 - -The Alpha-Omega Conflict
 - -Descent of Manas
 - -What is Islam?
 - -**Conclusion**
5. **The Celestial Hierarchies**
 - Dionysius the **Aeropagite**
 - The **Celestial Hierarchies**
 - -The **Chaldean** Planetary Spheres
 - -Three cultural Streams
 - -The Persian Academy
 - -Esoteric Christianity
 - -Traces in Medieval Art
 - -St. Thomas Aquinas
 - -The **Marriage** in Heaven
 - -The Rosicrucian enigma
 - -Table of correspondances
 - -A Last word from sister A.C. Emmerich
6. **Septenary in Human and Angelic Evolution**
 - (a) **The Pitris**
 - -Refused to create

- -Descent of the Manasaputras
- -Gorilla man
- -Genius
- -Orpheus Descending
- -Soul food

(b) Division of the Races

- -JHVH Influence
- -Earth Rotation
- -Return to Earth
- -The Race Spirits
- -The Temple Legend
- -The Atlantean Races

(c) the Universal Human

- -Sacrifice of the Ram
- -The Fall of Mankind-one key
- -The Lost Pleiad
- -The Universal Human
- -Conclusion

CHAPTER THREE - SYMBOLS OF SEVEN

- 1.-Cube and Triangle
- 2.-Cube Unfolded
- 3.-Inside the Cube
- 4.-Synergetic Cube Unfolded

CHAPTER FOUR - SYMBOLS OF TEN

1. PYTHAGORAS

- -The Tetractys and the square of four
- -More symbolism
- -Rosicrucian World Ages
- -**Hindu Yuga**Cycle.

2.Synergetic Tetractys

- -Tetractys Frequency Grid
- -Isotropic Vector Matrix
- -Cube Quanta Modules
- -Conclusion

3. The Solar Cycle of Naros

- -Convergence of Adepts
- -The Star of the Magi
- -The Two Jesus Children

CHAPTER FIVE - THE LAW OF TWELVE

1. Christian Rosenkreutz
2. Moses and Christ
3. Occult Twelfefoldness
4. Twelve Fold-ness of the Zodiac
5. Twelve Fold-ness of The Metals
6. Hexoctahedron Crystal Class
7. Evolution of Sphere Points
8. The Cuboctahedron

9. The Structural Model
10. The Founding of the New Mysteries

CHAPTER SIX - ANCIENT TWELVE-FOLD WISDOM

1. Adjoining Cosmoses
 2. Geocentric Astronomy
 - 3 . Chaldean Calendar
 4. The Twelve Degrees of Freedom
- 5. The Ancient Elements**
- -The Timaeus
 - -Geometry
 - -You are what you eat
 - -The Lamb in Aries
 - - The Lamb in the Second Seal
 - -The Atlantean Beast
 - -Table of Forces
- 6. The Akasha Chronicle**
- 7. The Fifth Gospel**
- 8. The Identity of the Teacher of Righteousness**

CHAPTER SEVEN-SYMBOLS OF TWELVE

1. The Tropical Zodiac
2. The Sidereal Zodiac
 - -The Planetary Rulers
 - -The 36 Stars of the Summerian Sun
 - -Arch-Angels of the Mystical Chronology
 - -Differences between the two Zodiacs
3. Symbols of the Tropical Zodiac
 - -The Amahraspands
 - -The Essene Belial
 - -The Eighth sphere
 - -The Abyss
4. Solstitial Gates of the World Cross
 - -The Breath of the Earth cycle

5. The Son of God and the Son of Man

The Macro and Micro Cosmic Principles of the Cosmic Christ

- The Docetic Vision
- The Fleeing Naked Youth
- The Son of God and the Son of Man
- Christ Died to the Sun
- The Macrocosmic Ego of the Cosmic Christ

CHAPTER EIGHT - THE SEPHER YETZIRAH

1. The Source in Abraham
2. The Hebrew Alphabet as Logos
3. The 231 Gates
4. The Crystal Space Groups
5. The Mineral Kingdom



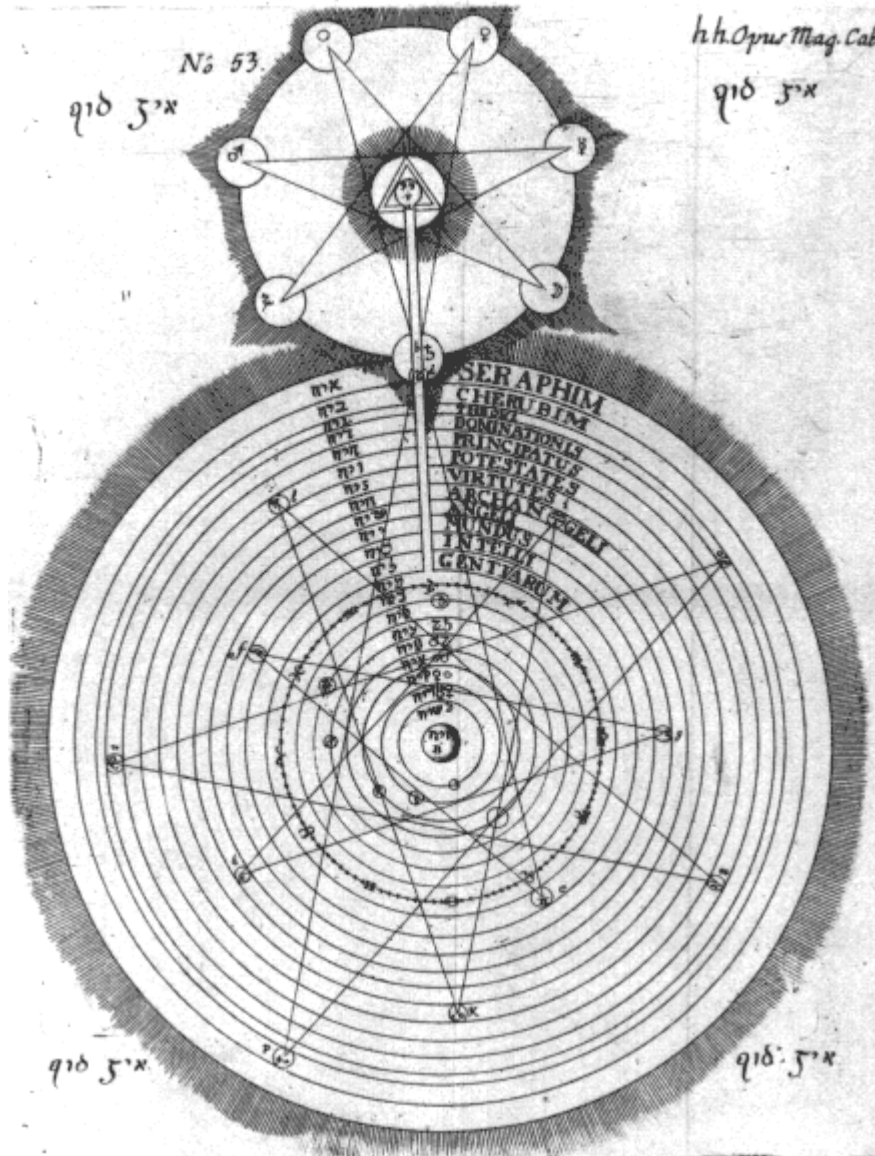

THE CELESTIAL TETRAHEDRON
AS FIRST GREAT SUBDIVISION OF UNIVERSE

1. ZOHAR

For the Quabbalists, the AIN-SOPH is the absolute, Supreme Deity, the one eternal state of being, and symbolized by the circle, within this circle all worlds are manifested, thus creating all this is inside and all that is outside.

In the process of creation, the manifest life of the AIN-SOPH proceeds from the circumference to the center, and establishes a point. The two dimensional symbol is now shown as plat no. 1 .

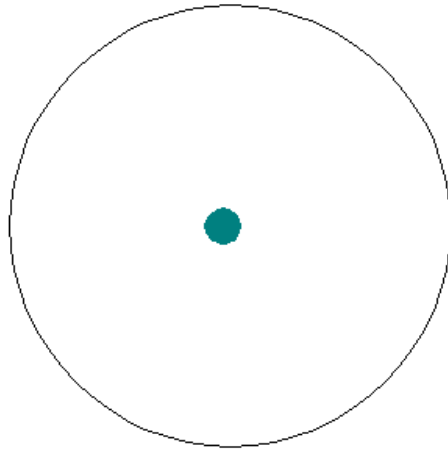

Primary first circle of god

With the circle as the first limitation defining the limits of space and the second limitation as the point, a universal germ, AIN-SOPH no longer shines through space, but rather upon space from an established first point.

The ZOHAR further establishes 40 rates of vibrations or subdivisions of the manifested AIN-SOPH, represented symbolically as concentric circles within the primary circle of the limits of space.

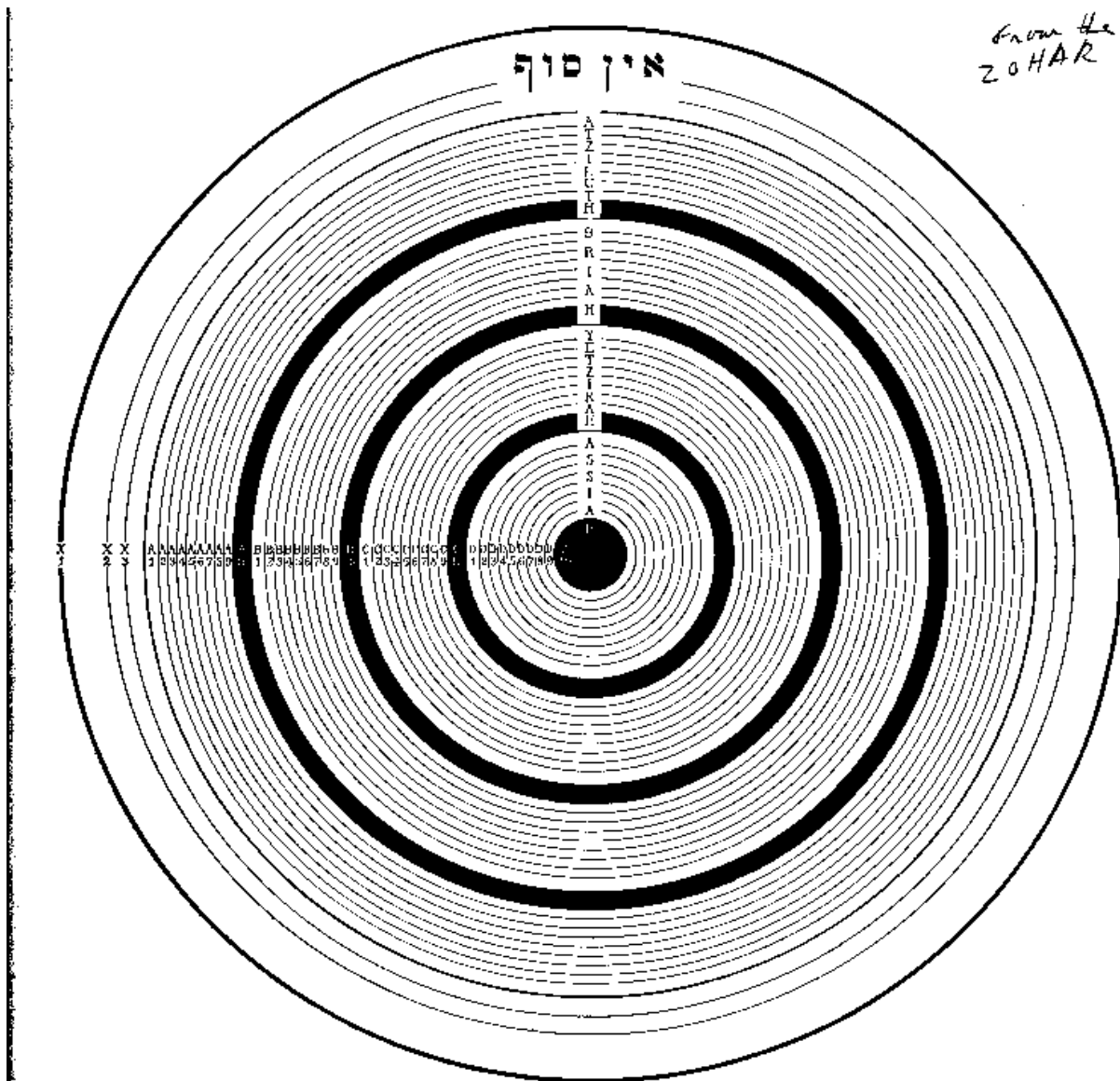

For informational purposes, the 40 circles of creation from the AIN-SOPH, are divided into 4 great circles of world chains, consisting of ten subdivisions each. The four world chains (A, B, C, D) are called:

- A 1-10, Atziluth or Boundless world of Divine Names;
- B 1-10, Briah, or Archangelic world of Creations;
- C 1-10, Yetzirah or Hierarchal world of Formations;
- D 1-10, Assiah or Elemental world of Substances.

Now, these four world chains between the great circle and the central point do not concern us for the purpose of the celestial tetrahedron. What is important is that the ZOHAR pre-establishes two additional circles between the great circle and the first subdivision called Atziluth. Thus, the internal, unmanifested nature of AIN-SOPH is divided into three parts represented by the concentric circle spaces respectively between the outer circle (x) as follows:

- X to X-1, AIN, the vacuum of pure spirit;
- X-1 to X-2, AIN-SOPH, the limitless and Boundless;
- X-2 to X-3, AIN-SOPH-AUR, the limitless Light.

Thus, from the outer circle (x) to the central point, are three circles representing the three in one unity of the unmanifested AIN-SOPH. From this unmanifested trinity comes the manifested worlds represented by 40 great subdivisions. The ZOHAR symbol for the celestial tetrahedron is now as shown with each successive circle being a limit on the preceding.

As stated by Manley P. Hall,

"It should be borne in mind that in the beginning the Supreme Substance, AIN, alone permeated the area of the circle; the inner rings had not yet come into manifestation. As the Divine Essence concentrated Itself, the rings X 2 and X 3 became apprehensible, for AIN SOPH is a limitation of AIN, and AIN SOPH AUR, or Light, is a still greater limitation. Thus the nature of the Supreme One is considered to be threefold, and from this threefold nature the powers and elements of creation were reflected into the Abyss left by motion of AIN SOPH towards the center of Itself. The continual motion of AIN SOPH towards the center of Itself resulted in the establishment of the dot in the circle. The dot was called God, as being the supreme individualization of the Universal Essence. The name of this point is I AM, called by the Hebrews Eheieh and it controls and contains all other emanations."

Further the central point represents the crown or Kether of the Sephirothic Tree. There are four trees, one in each of the four world chains. The central point controls and contains all the 39 circles within the four world chains which it encloses. Thus, the ZOHAR establishes the concept of the three forces of the trinity outside the central dot as unmanifested universe and the central dot as a separate world unto itself consisting of 40 subdivisions divided over 4 world chains of manifested universe.

This cosmic seal set forth in the ZOHAR is the esoteric wisdom of one of the three books of the Quabbala. Despite the ravings of H.P. Blavatsky against the Hebrew alphabet as essentially phallic and the medieval books of the Quabbala as altered to suit Christianity, she unequivocally accepts the ZOHAR as representing the Hindu cosmology described in The Secret Doctrine as follows:

"The entire scheme is in the Chaldean Book of Numbers, and even in the ZOHAR, if one only understood the meaning of the apocalyptic hints. First comes Ain-Soph, the "Concealed of the Concealed," then the Point, Sephirah and the later Sephiroth; then the Atzilatic World, a World of Emanations that gives birth to three other worlds: (the first, the Briatic World or World of Creation), called the Throne, the abode of pure Spirits; the second, the World of Formation, or Yetziratic, the habitat of the Angels who sent forth the Third, or World of Action, the Asiatic World, which is the Earth or our World; and yet it is said of it that this world, also called Olam ha-Kliphoth, containing the (six other) Spheres, Galgallim, and matter, is the residence of the "Prince of Darkness." This is as clearly stated as can be; for Metatron, the Angel of the second or Briatic World, means Messenger, Angel, called the great Teacher; and under him are the Angels of the Third World, or Yetziratic, whose ten and seven classes are the Sephiroth, of whom it is said that "they inhabit and vivify this world as Essential Entities and Intelligences, whose correlatives and contraries inhabit the third or Asiatic World." These "Contraries" are called the "Shells," (Kliphoth), or demons, who inhabit the seven habitations called Sheva Hekhaloth, which are simply the seven zones of our globe. Their prince is called in the Kabala Sammael, the Angel of Death, who is also the seducing serpent Satan; but that Satan is also Lucifer, the bright angel of Light, the Light-and Life-bringer, the "Soul" alienated for the Holy Ones, the other angels, and for a period, anticipating the time when they would have descended on Earth to incarnate in their turn." In, conclusion, the 14th century ZOHAR repeating the wisdom of the ancient Chaldean Book of Numbers, clearly defines the unmanifested universe of the celestial tetrahedron as a trinity of three concentric circles localizing a central dot, which dot in turn, represents the manifested universe and its subdivisions.

2. CIRCLE-TRIANGLE

A geometrical evolution has occurred from the early representation of the unmanifested world as a symbol of three circles and a center point. For example, G.I. Gurdjieff in explaining his law of reciprocal maintenance sets forth a series of twelve essence groups called the Trogoantogocrat. At the top of the ladder he represents the absolute or unmanifested deity as a circle, with an inscribed triangle and a central dot. Likewise, the Quabbalists represent the first three Sephiroth, Kether, Binah and Hochma as a triangle, represented by the letter 'shin', and circumscribed by a circle. Also, all the major books of theosophy represents the triple aspects of Deity with a triangle, symbolic of the higher unity of Manas-Buddha-Atman.

In fact, every exoteric religion has evolved the symbol of the three aspects of Deity into a circle, inscribed with a triangle and central dot, replacing the three circles of the Zohar with a central triangle as follows:

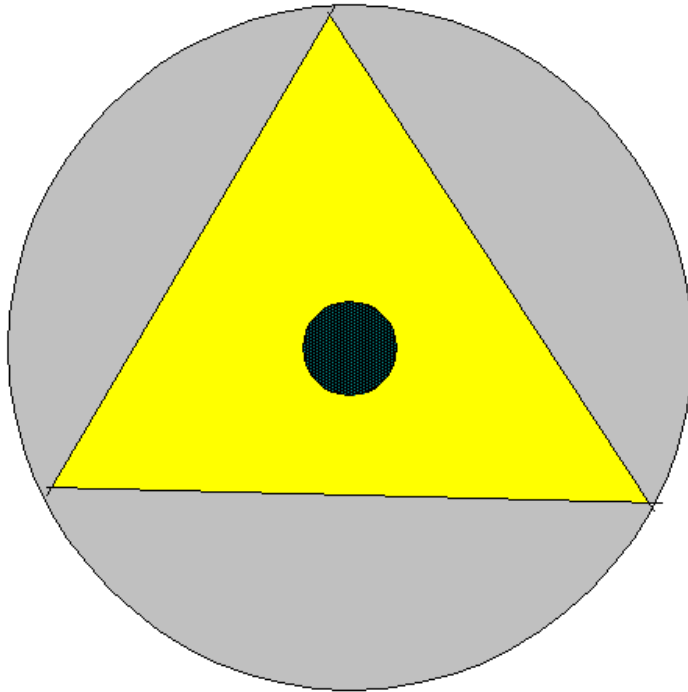

God as circle, with 3 circles of Zohar Replaced with 3 triangles

3. GOD AS TRINITY.

The reason for the evolution of the three circles into the triangle is that upon recognition of the three aspects of God - Absolute- Ain-Soph etc., the triangle is more geometrically representative. Thus, the outer circle still symbolizes the limits of space in which the deity acts but the deity itself becomes represented by the triangle. The triad or triangle has become a universal exoteric symbol of deity in its three aspects.

Again this took historical time to achieve because the evolution of exoteric religions, also progressed in stages. The first cultural epoch or first religion represented by the Hindu-Brahman can be thought of as a plurality of gods in unity as a circle. The second cultural epoch represented by the Persian-Zoroastrian, can be thought of as the emergence of Duality, as Ahura-Madza and Ahrihman. Not until the third cultural epoch as represented by the Egyptian-Chaldean, do we see the first emergence of the three aspects of god as a trinity or triangle. Thenceforth, god can be represented as a trinity in all religions as follows:

RELIGION	TRINITY		
Hindu	Brahma	Shiva	Vishnu
Christian	Father	Son	Holy Spirit
Hebrew	Kether	Hochma	Binah
Egyptian	Osiris	Isis	Horus
Persian	Ahura-Mazda	Vohuman	Asha Vahishta
Scandinavian	Thor	Freya	Odin
Druid	Taulec	Fan	Mollec
Babylonian	Anu	Ea	Bel

R Steiner explains this evolution of deity as unity then duality then trinity as follows:

"The first period, the primeval Indian, developed a religion that seems like an inner lighting-up, an inner repetition, in ideas and feelings, of the very first period, when sun and moon were still bound up with the earth. The spirit who, in the first condition of the earth, in the primeval mist, connected himself with all angels, archangels, high gods, and spiritual being, was for Indian consciousness summed up as a single high individuality under the name of Brahm or

Brahma. This first post-Atlantean culture recapitulated in the spirit what had happened earlier. It is a repetition of the first epoch of the earth, in its inner aspect.

"Now let us look at the second cultural period. In the principles of light and darkness we have the religious consciousness of the primeval Persian period. The great initiate saw an opposition between two beings, one of the which was personified in the sun and the other in the moon. Ahura Mazda or Ormuzd, the Light-aura, is the being whom the Persians venerated as the highest god. Ahriman is the evil spirit, the representative of all the beings who belonged to earth-plus-moon. The religion of the Persians is a remembrance of the second epoch of the earth.

"In the third cultural epoch, man had to say to himself, "In me are the forces of the sun and of the moon; I am a son of the sun and a son of the moon. All the forces of the sun and of the moon appear as my father and my mother."

Thus we have UNITY in the primeval past as the attitude of the Indian; while the DUALITY that appeared with the separation of the sun is reflected in the religion of the Persians; and in the religious views of the Egyptians, Chaldeans, Assyrians, and Babylonians we find the trinity that appeared in the third cultural epoch. Trinity appears in all religions of the third period, and in Egypt is exemplified in Osiris, Isis and Horus."

Of course, the Hindu and Persian had a trinity in their esoteric cosmology, but these were not revealed by the Vedas and Manes, respectively, until after the establishment of the Egyptian trinity.

4. LAW OF THREE

Now, the triangle represents everything with a threefold nature and as such, its possibilities of representation are infinite. However, we do not want to confuse the triangle as unmanifested deity with the triad as manifested in the created universe. The celestial tetrahedron is the three aspects of deity unmanifested and represented, for now, as a triangle. The manifestations of deity in the created world are also threefold such as the triads of the primary colors, the equilateral triangle in Masonry, triad of sun, moon and earth, etc. However, the latter triads are manifestations of the law of three in physical, created universe of nature and do not concern us in discussion of the celestial tetrahedron. However, an explanation of this fundamental occult law will help later in explaining how deity contains within itself the three forces, universally recognized as the occult trinity.

The medieval Christians were the first to reveal as an exoteric symbol the principal of the law of three. In an effort to explain in an appropriate symbol the Christian doctrine of the triune nature of God as Father, Son and Holy Ghost as separate, yet one unity, many European churches (built by anti-Catholic masons of course) display the following symbol of God as trinity.

Here we see the Father, Son and Holy Ghost separated as three circles but connected by two aspects of two forces called EST and Non-EST. These represent the active and passive forces. In other similar symbols, we see reference to a third force called the neutralizing force. Together, these three forces, active, passive and neutralizing, represent the three aspects of Deity unmanifested. As manifested, we need a fourth resultant combining the three into the matter of physics.

Although the trinity of three forces appear in numerous esoteric occult teachings such as the Salt, Sulphur and Mercury of Alchemy, no clear exoteric explanation is given until the publication of The Secret Doctrine in 1888 by H.P. Blavatsky and later In Search of the Miraculous by P.D. Ouspensky in 1949. In the latter, G.I. Gurdjieff explains the law as follows:

"Every phenomenon, on whatever scale and in whatever world it may take place, from molecules to cosmic, is the result of the combination or the meeting of three different and opposing forces. One force, or two forces recognized by modern science as positive and negative, alone can never produce a phenomenon. The presence of a third force is always necessary. The first may be called active or positive; the second, passive or negative and the third, neutralizing. The first two forces are obvious to any person as positive or negative, male-female, good-evil, etc. However, the third neutralizing force is difficult of observation.

"Also, all these forces are just names for what in reality appears as all three forces are equally active, passive and neutralizing only in their meeting points and only in relation to one another at a given moment in time. For example, the element carbon is much more active in the organic world than it is in the mineral world as is silicon more active in the formation of the earth's crust than it is in the organic world.

"The relationship of the three forces to the trinity is that the three forces acting together form a trinity which produces a new phenomenon. Thus, the three in one, when manifested form a fourth complete whole as matter and subdivisions, thereof: This concept is the essence of the celestial tetrahedron, the three forces as trinity produce a fourth, manifested as matter, the first subdivision of material, created and physical universe which can be counted, weighed, built upon, lifted and observed. The tetrahedron represents the three forces as trinity of god (spirit) and the fourth as matter.

Further, Gurdjieff explains:

"The four aspects or states of every substance have definite names.

When a substance is the conductor of the first or the active force it is called 'carbon,' and, like the carbon of chemistry, it is designated by the letter C.

When a substance is the conductor of the second or the passive force, it is called 'oxygen,' and, like the oxygen of chemistry, it is designated by the letter O.

When a substance is the conductor of the third or neutralizing force, it is called 'nitrogen,' and like the nitrogen of chemistry, it is designated by the letter N.

When a substance is taken without relation to the force manifesting itself through it, it is called 'hydrogen,' and, like the hydrogen of chemistry, it is designated by the letter H.

The active, the passive, and the neutralizing forces are designated by the figures 1, 2, 3. and the substances by the letters C, O, N, and H."

Although the basic concept of the law of three is ancient, the modern notation of C-O-N-H used by Gurdjieff was most likely borrowed from Madame H.P.B. in *The Secret Doctrine*. She says,

"The numbers 3 and 4 are respectively male and female, spirit and matter and their union is the emblem of life eternal in spirit on its ascending arc and in matter as the ever resurrecting element by procreation and reproduction ... The former (the 3) is invisible (as spirit) and the latter (the 4) is on the plane of objective perception (as matter). This is why all the matter of the universe, when analyzed by science to its ultimates, can be reduced to four elements only C-O-N-H; and why the three primaries, the noumena of the four, or graduated spirit or force have remained a terra incognita."

In conclusion, God as Trinity, represented as an equilateral triangle, for exoteric purposes revealed as the triple aspect of deity, while for esoteric purposes is concealed as the ancient law of three.

5. SEPHIROTH TREE

The principal of three as Spirit and unmanifested cosmos passing into four as matter and manifested cosmos has its prima-facie origin in Western occultism in the *SEPHER YETZIRAH* book of the quabalah. The esoteric symbol of the Quabalah is the Sephiroth Tree of Life (from Kircher).

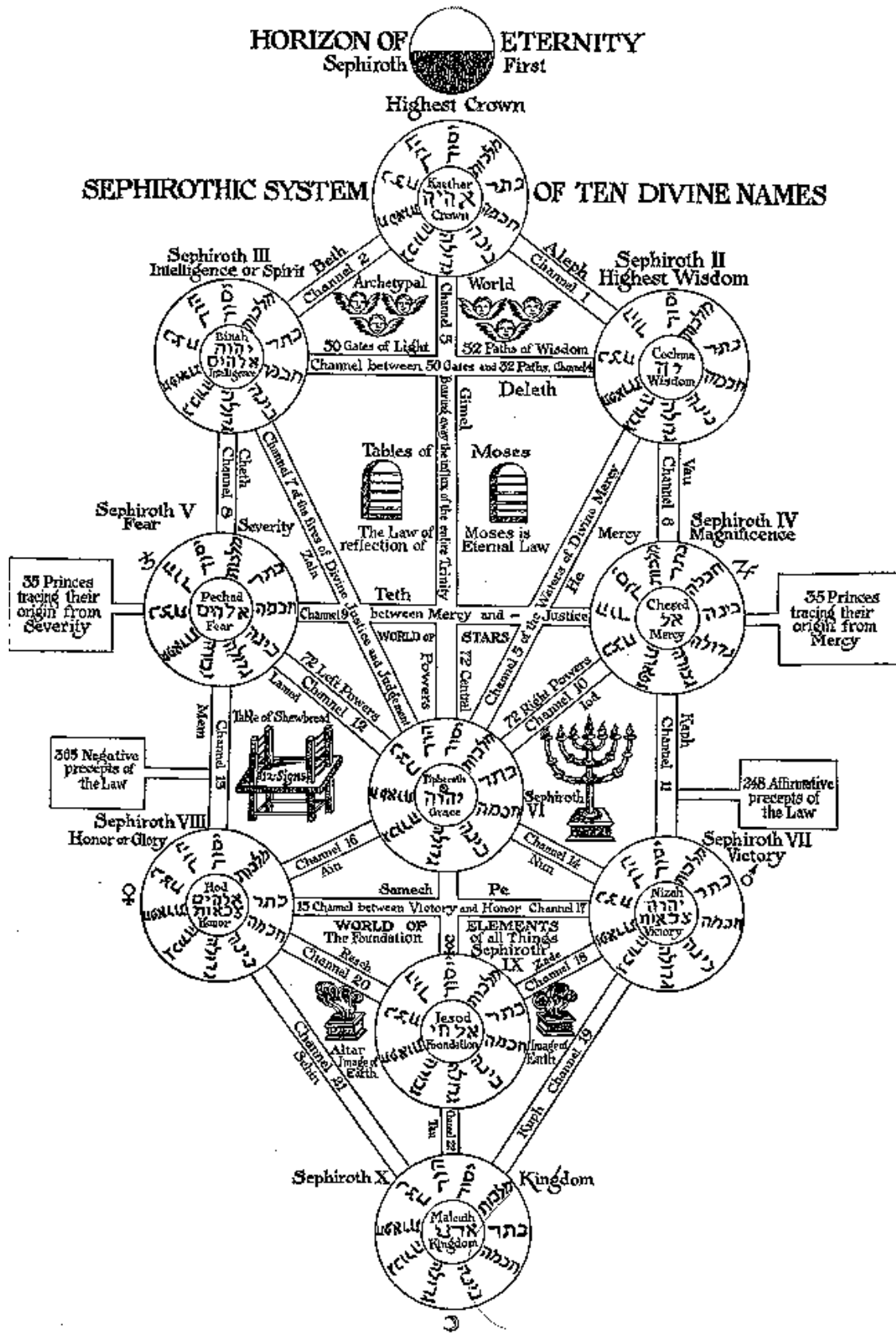

THE SEPHIROTHIC TREE OF THE LATER QABBALISTS.

Translated from Kircher's *Edipus Aegyptiacus*.

From the AIN SOPH represented, as before, by the O circle beyond and above all number, emanate a succession of ten Sephiroth.

Do the first three Sephiroth, shown as Kether, Binah and Hokhmah, represent the trinity as Law of Three?

Consulting some Quabbalahistic sources we find: IBN Geberol saying, "The triad is the root of everything"; the Idrak Zootah says; "The Ancient, whose name be blessed! has three heads which are yet one head"; and Issac Myer saying, "The triad of the Ancient Quabbalah is Kether, the Father; Binah, the Holy Spirit or Mother; and Hokhmah, the Word or Son; which three are distinguished from the other Sephiroth and are called the 'upper holy triad' and together form the Intellectual World (A'Tzeel atic world) and govern the head."

This upper holy triad has always been distinguished from the lower triads emanating from the lower seven Sephiroth, because in fact, the Quabbalahists intend this first triad to represent the trinity. From Kether, emanates the opposition, the female and male, the negative and positive principals. Together, the three are one, in unity.

How then does the three as trinity pass into the four as matter in the Quabbala? From the third Sephiroth Hokhmah, emanates the fourth sephiroth known as HESED. The Zohar says that from the breast of Hokhmah, the word, the divine son emanated six principals or Sephiroth called the "Sephiroth of Construction". Issac Myer says these symbolize the dimensions of matter, the six sides of the entire universe, the six days of building (from Genesis), be it an atom or universe, as represented in the three dimensions of Length, Breadth, Depth, and the positive and negative poles of each of these. These six dimensions of the material or manifested cosmos are represented as the six sided cube with a numerical Hebraic script value of 72.

Thus, the trinity as the upper holy triad of the first three sephiroth pass into the fourth sephiroth HESED and its emanations as the constructed or manifested world represented by the dimensions of matter.

Another interesting way we see the three pass into the four as represented in the Zohar is by the great name of the Tetragrammaton represented in the name of God written as Jehovah (YHVH and pronounced as ADONI). The Zohar says, "There are four lights! Three of them are concealed and one is revealed.

The letter of Kether is Y-Yod, of Binah H. Heh and of Hokhmah which is a complete symbol in itself of the name of God as representative of the trinity. However, a fourth letter is always added to the name of God making the complete Tetragrammaton of four letters. The letter H is added at the end, thus YHVH. The reason for this is explained by Issac Myer as the last letter H of this ineffable name being always applied to the six lower and last Sephiroth represented, as above state, in the Fourth Sephiroth of Construction, HESED. The first three sephiroth represented the upper holy triad in the first three letters Y-H-V and the lower Sephiroth of Construction in the fourth letter repeated as H as HESED. Taken together, we have the sacred holy name of Jehovah, the Tetragrammaton, as YHVH expressed as three letters plus one making the four letter name of God.

This mystery of the holy name as representative of the principal of three passing into the four has been aptly commented upon. "If thou art attentive to that most holy name of the Deity (that is the Tetragrammaton or four lettered name YHVH) as found explained in the mysteries of mysteries, thou beholdest, a name of three letters, thou of four symbols, one of them a twin, being written twice, that is, the H-HED. If anybody examines them, he can see that the very name represents both one and three, truly each pointing to the oneness of the substance, so that it shows the trinity of persons."

The first and second letters form YH, the second and third letters form HV and the third and fourth letters VH, joined together they form the one great name YHVH. Thus, the three letters (of the trinity) form a unity of four (the constructed world of matter).

6. TETRAHEDRON AS MATTER

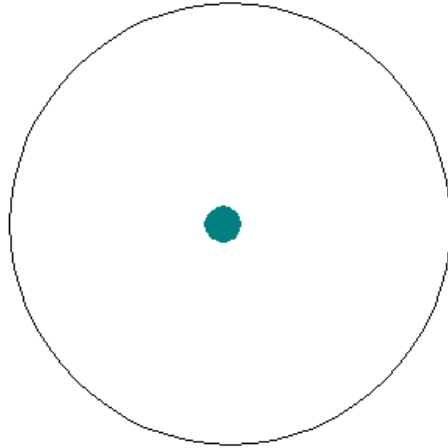

Primary first circle of god

The tetrahedron like, the first circle of the ZOHAR, is the first subdivision to divide the universe into two parts: all of the universe inside the system and all the universe outside its system. Buckminster Fuller has examined the tetrahedron as the sum of the forces of the law of three in several ways.

In solving the relationship of plane geometry and Galileo's parallelogram of forces, he thought of the basic mathematical problem of ships on a collision course on the ocean. One ship was drawn on a plane running at a certain velocity in a given direction. Multiply its weight times its velocity and make a length of a line called a vector. Then likewise, vector the other ship. Then, make two other lines parallel with the first set of two vectorial lines and make a parallelogram with the first two vectors.

Next, make a line diagonal in the parallelogram from the point of collision to its diagonally opposite corner. The external equidistant extension of the diagonal of the parallelogram was called the resultant of forces. From this diagram the two ships after collision are supposed to go in the same somewhere direction for some miles. Of course, this does not really happen after the collision because one ship sinks to the bottom of the ocean.

Now what Fuller recognized was that modern science did not recognize what we said earlier about the neutralizing force. The third force is very difficult for the average person to see. Although, science grasped the idea of the fourth force or resultant, (our hydrogen as the combination of the three forces), it did not grasp or recognize the third force or nitrogen principal. Fuller found that in reality four forces are operating on the ships at sea. Two forces accelerate conically together, rising from the earth, plus gravity, plus the resultant. So when the two ships collide, they really want to rise up against gravity, and they could if they had enough speed, but instead they sink or go a few yards in the direction of the resultant of forces. The pattern of real forces looks very much like a music stand, three vectorial legs spread out with a fourth vertical vector.

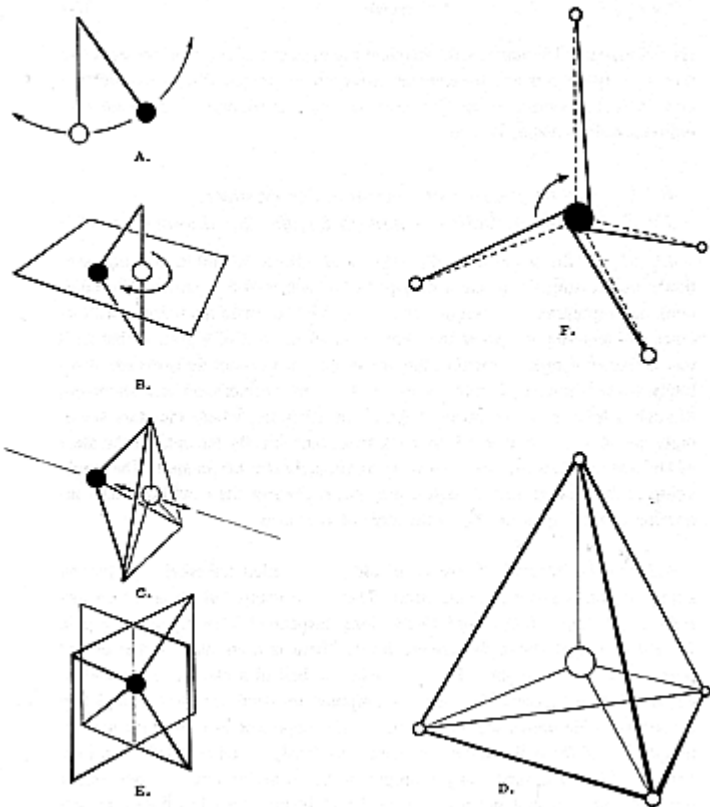

Fuller shows the creation of the first subdivision of universe as a tetrahedron in plat no. 1 . The ball on the string is anything. The string however long is the force of gravity as the combined mass attraction exerted upon one by all the stars in universe. It can move in any direction but it cannot get out of or absolutely away from the universe, so the single string is always attached to it.

Turning the mass attractions of the stars into two hemispheres, those to the left and those to the right. We find itself like a ping pong ball suspended in the middle of a one string fiddle with two restraints. It can still move but only on a plane perpendicular to the string, in circles, or cloverleaves, etc.

With three restraints, It moves only as if in the middle of drum head and in a line perpendicular to the plane of the drum head or web triangle. With one restraint, the ball was moving omnidirectionally and multidimensionally. With two restraints, it was moving in a plane and with three restraints, only in a line. Finally, with four restraints, the ball is immobilized and represents a minimum system.

Although restrained from directional motion, the center ball can still create or move as the center dot in the ZOHAR represented 39 subdivisions of influences. The ball can still turbine, rotate, and precess locally in space without altering the geometric position at volume center of the celestial tetrahedron from whose four corners the four vectors of restraint were imposed. It can rotate in place around an axis and that axis can incline at many angles like a gyroscope top without altering its volumetric center.

The tetrahedron is a triangularly faceted polyhedron of four faces. It is unique as the minimum system. All matter of physical universe, as manifested, is in the primary form of a tetrahedron. Modern science recognizes this in organic chemistry, mineralogy and crystallography.

7. PYTHAGORAS

Pythagoras knew how the law of three produces the fourth as matter or form. From his travels, he learned the Hindu, Persian and Egyptian systems of esoteric and exoteric knowledge. He was also initiated into most if not all then existing mystery schools. He taught his students that "all things consist of three" and "establish the triangle and the problem is two-thirds solved". Besides establishing the famous geometrical theorem, the tetractys, the five (platonic) solids and the musical geometry of the spheres, he established how number is related to form .

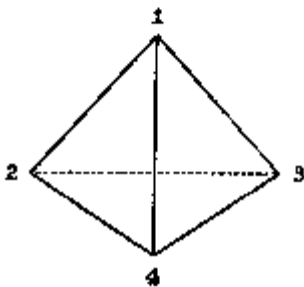
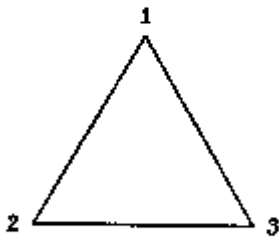

The dot was the monad or number 1; The line, the power of 2; the triangle, the power of 3 and the solid tetrahedron, the power of 4. Note, when he established the solid or primary matter as the fourth power, he did not use the cube (the traditional ancient symbol of Earth) as the form, he used the tetrahedron. He knew how the three forces together formed the first solid dimension. I would like to know the results of an investigation of the karmic relationship between Pythagoras and B. Fuller, either as reincarnation or channel. Gurudas in his first book on Vibrational Healing states that B. Fuller received channeled information (from the music of the spheres, no doubt).

What Euclid was to geometry for the past two millenniums, Fuller will be to the future millenniums.

8. TETRAHEDRON AS PRIMARY ATOM-EVENT

B. Fuller further examines the tetrahedron as an energy event comprising the law of three.

An open ended triangle can be considered as one energy event consisting of our three forces of action, reaction and resultant. Two such tripartite vector spirals or open triangles, one positive and one negative, combine to form the tetrahedron.

One set of three vector open triangle groups corresponds to the proton (with its electron and anti-neutrino) and the other set of three vector triangle groups corresponds to the neutrino (with its positron and neutrino). Each of these groups is identified by nuclear physics as one-half Plank's constant or one-half spin or one-half quantum.

When brought together, these two sets of three vector groups form the six edges of the tetrahedron which is the conceptual unit of one energy quantum or atom.

Thus, Fuller establishes the Law of Three (active, passive and resultant forces) in two sets as constructing the primary atom or element as a tetrahedral form. (See Plat no. 2 for illustration.)

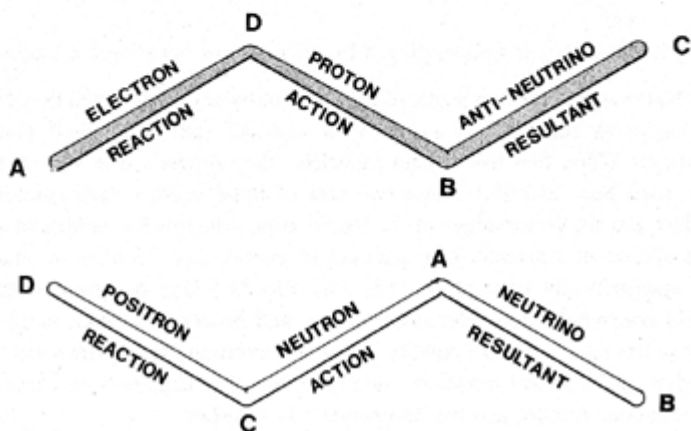
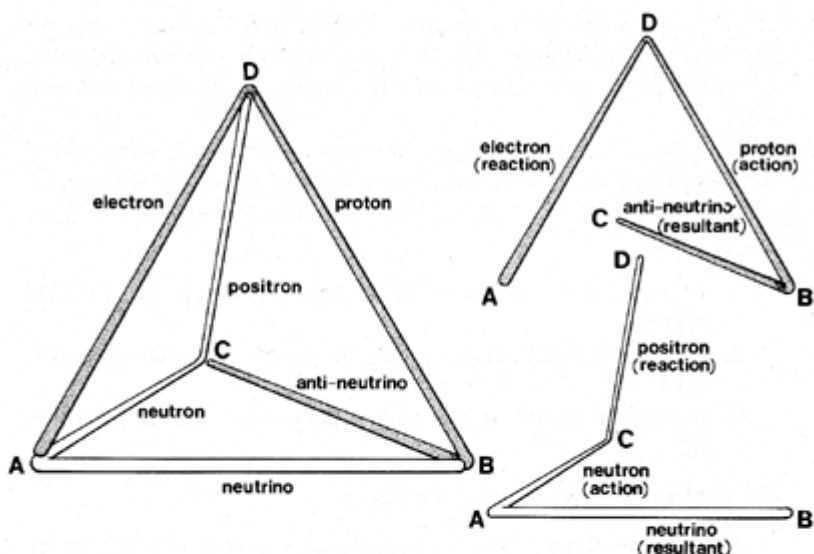

9. CONCLUSION - HARDLY

Having established: (1) the ancients represented the three aspects of deity as an equilateral triangle; (2) the deity as a triangle represented the unmanifested spirit in its three aspects; (3) the law of three represented the esoteric version of the three aspects of Deity as active, passive and neutralizing forces inherent in all matter; (4) the deity as triangle transforms into the tetrahedron, as three becomes four and spirit becomes matter; (5) spirit and matter as four in tetrahedron is the first subdivision of matter; (6) Fuller established the tetrahedron as the special form of the primary atom event.

Therefore, using the isotropic law of "as above, so below," since in the microcosm, the atom is formed as tetrahedron, so in the macrocosm, the celestial sphere is formed as the celestial tetrahedron. (Thus, the name of this exercise.)

However, this symmetry does not work. We cannot replace the primary First Circle with primary first triangle. That is why the tetrahedron should not be thought of as universe of deity but as the First Subdivision of universe as our familiar zohar circle..

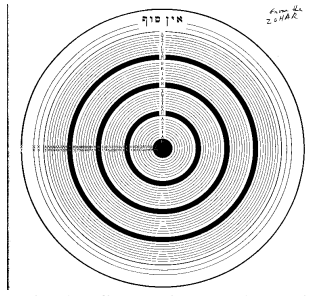
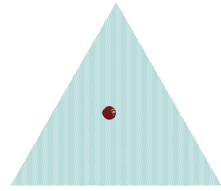
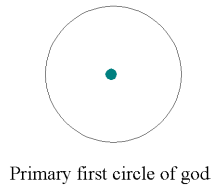

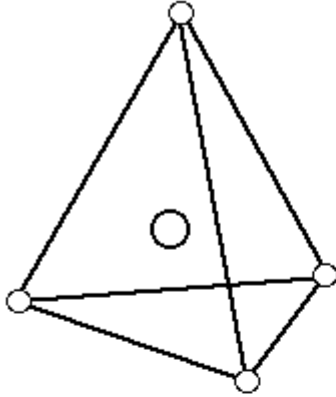

The scientific reasons for this are at least twofold. First, although the tetrahedron is the first prime volume in universe with a unique domain, it does not have a nucleus. As Fuller shows, a prime volume is different from a generalized regenerative system. Generalized regenerative systems have a nucleus and prime volumes do not. There are only three prime volumes: tetrahedron, octahedron and icosahedron. Prime volumes are characterized exclusively by external structural stability. Thus as a structure of cosmic hierarchy, the tetrahedron has the structural stability befitting its lofty status, but no center, and we cannot have a representation of deity with no center - this is blasphemy. (Actually, inside a tetrahedron comprised of four tangent spheres, there is no central sphere but there is a hole or curved convex space in the shape of an octahedron. So something could fit inside here).

Second, the tetrahedron alone, consisting of only four vectors of restraint can still move in several directions. In a nuclear domain of four close packed spheres, the tetrahedron system is stable as in Plat no. 3 . However, in a celestial domain of four vectors of restraint defining an inside-outside domain of universe: (1) each of the four corners can be pushed, thus turning the tetrahedron inside out in four directions (concave-convex) or (2) the entire tetrahedron can rotate in a 360 direction (precess locally within its celestial sphere). As shown in Plat no. 4 ,it takes a minimum of twelve vectors of restraint to immobilize the center ball of the tetrahedron , to keep it from motion to turbine, rotate or precess. Each of the four corners of the tetrahedron need three vectors of restraint to lock the four corners in place.



Four vectors define a point or ball with no displacement. However, it can still rotate, turbine and precess in place. The ball lies at the center of gravity within the tetrahedron.

Replace each corner  with a triangle  as then, there are 3 vectors or restraint at each of the 4 corners of the Tetra and attached tangentially to the ball at the center, the 12 vectors completely restrain any motion at the central ball in relation to the other four. Now, locked in place. The result is the tensegrity tetrahedron shown next .

It takes a minimum of 12 spokes to fix the hub position in relation to the rim.
The 12 spoke wheel is like the 12 vector tensegrity tetrahedron.
It takes 12 vectors of restraint to lock in the center.

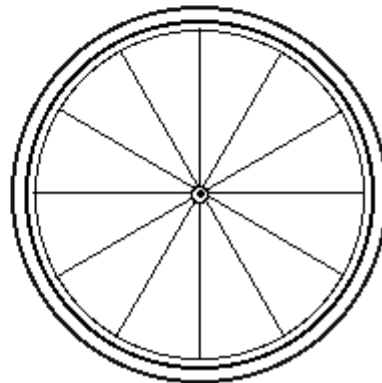

Thus, to have a celestial tetrahedron as permanent and immobile, locked in place, we need to have "four external star foci events" restrained by three sets of vector tensions each.

"The cohering integrity of universe is manifest to us by consideration of the celestial advantage point from which our four central restraints were mounted to prevent local in position twist and torque, each of the four corner tensional restraints will have to be multiplying replaced by three restraints, all springing from three external points at each of the four tetrahedral corners; and each of the three tensions from any one of the four corners must cross the others triangularly and be attached tangentially to the ball at the center." (B. Fuller) This concept is represented in the following diagram as a tensegrity tetrahedron .

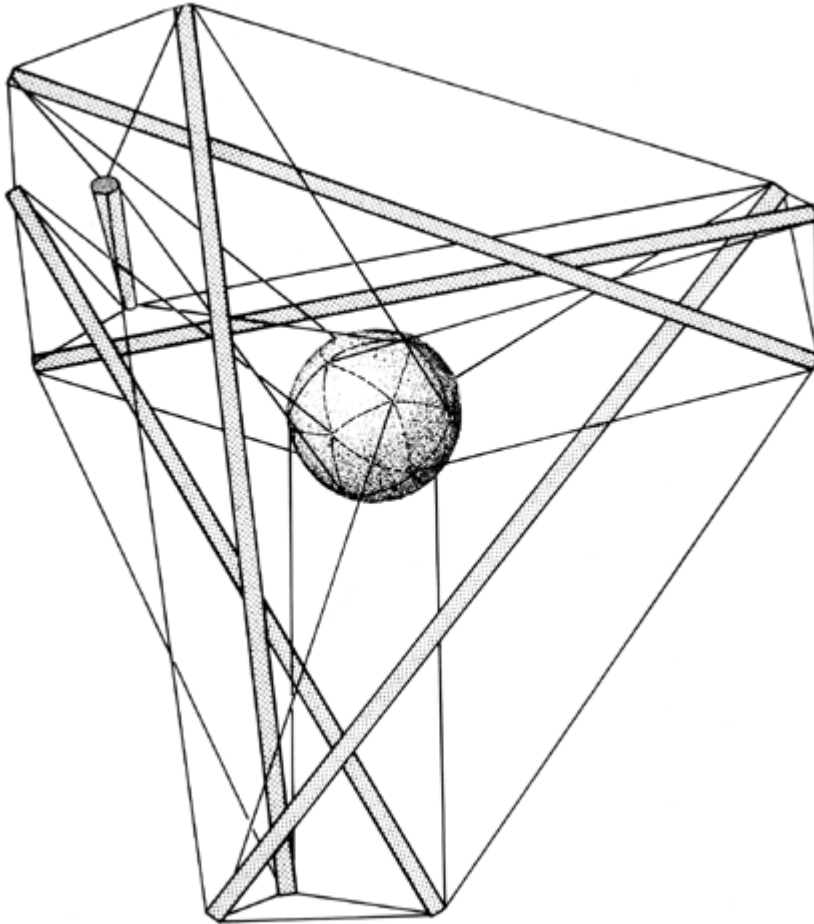

Now, our search here has not been to find how to restrain the center of a tetrahedron or restrain the center dot of the Zohar symbol. It has been to define a celestial tetrahedron which we know somehow must exist in fact, but we became mixed up in twelve vectors of restraint as necessary to define a tetrahedron that evolved formerly with four vectors of restraint.

Now, we know that to have a celestial tetrahedron, it must be defined by four external star foci events, located somewhere in our celestial sphere, from which each of the four corners must project three sets each of tension vectors of restraint!!

Now, before we locate and define the four corners of the celestial tetrahedron, we should ask if we still have a circle circumscribing the triangle or tetrahedron as or if now after the analysis, the tetrahedron is outside and the circle inside as .

10. CELESTIAL SPHERE

What is the external shape of the perimeter of universe? Is it the circle of the Zohar within which circle our worlds are manifested or is it the triangle or tetrahedron within which we also know all can be separated into inside and outside? We must keep in mind that the universe is expanding (after Hubbel) and space is curved (after Einstein). The latter would suggest an easy solution and end the discussion here, but.

Fuller also observed and defined a mathematical phenomenon known as a geodesic. It is the most economical relationship between any two events. Just as a line is the shortest distance between two points on a plane, a geodesic line is the shortest distance between any two points on the outside of a sphere. A sphere composed of geodesic lines is called a geodesic sphere and includes all the principals of tensegrity.

Each line on the perimeter of the geodesic sphere defines a great circle. A great circle is mapped when a regular polygon is rotated inside the sphere and the nodes of the polygon trace a circle on the sphere. For example, we know that our celestial tetrahedron with only four vectors of restraint can still rotate in place. If we rotate this tetrahedron,

each of the four modes define four great circles on the geodesic sphere. Plat no. 5 shows the four great circles of the tetrahedron inscribed on the sphere, and the six great circles of the octahedron and the 20 circles of the icoshedron.

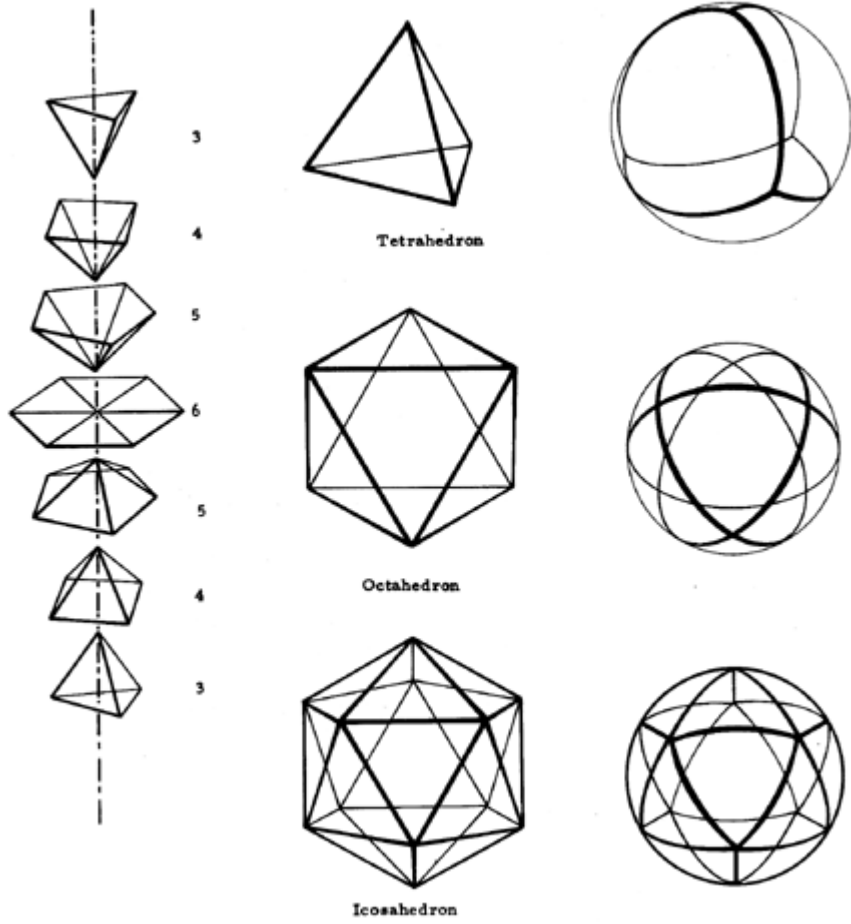

Likewise, for illustration, Plat 6 Plat No. 6 shows the many great circles of another geodesic.

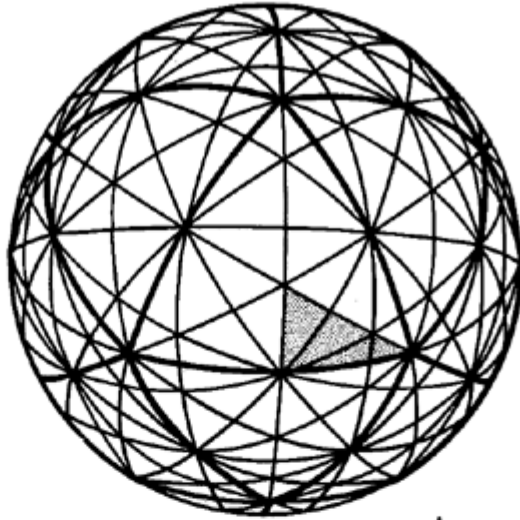

A.

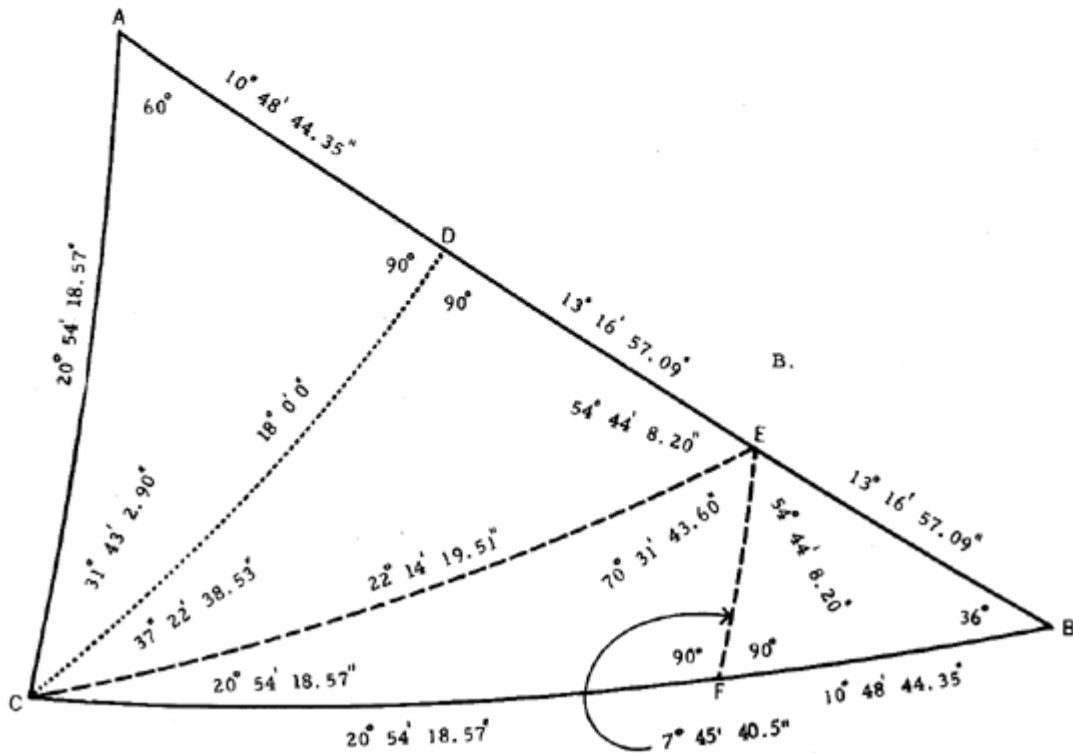

Thus, if we spin the celestial tetrahedron inside the celestial sphere, we can have it both ways. The external shape of the perimeter of universe is neither a circle nor triangle, and we do not have to address the issue of which is first. The celestial sphere is a geodesic sphere defined by the great circles of the inscribed polygon, which at a minimum is the four great circle celestial tetrahedron and a maximum, zillions of great circles tracing the rotating star events of the Milky Way Galaxy! Thus, our familiar Zohar triangle prevails as unity.

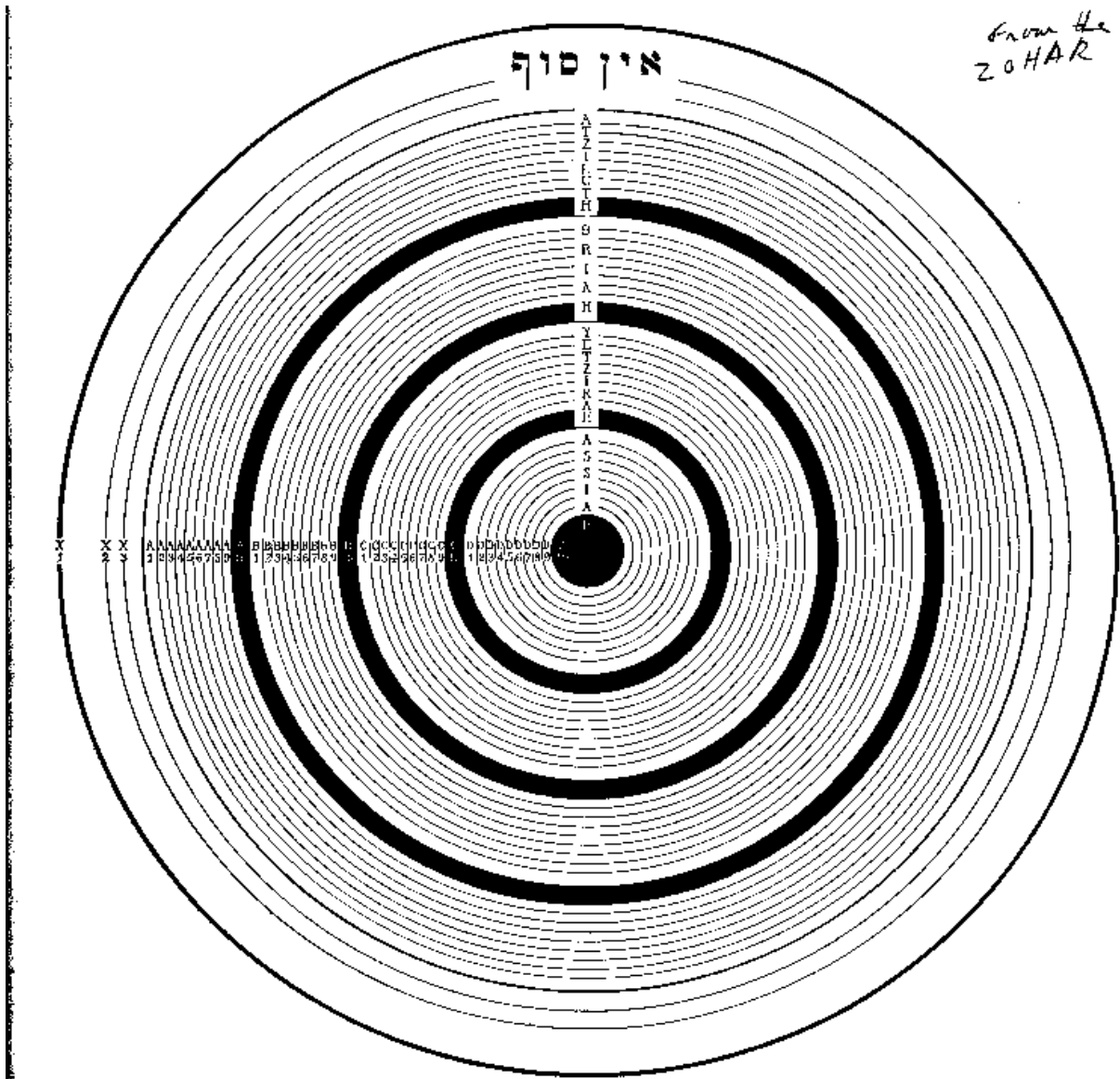

Incorporated by synergy into our celestial sphere is the concept of tensegrity. Fuller created the word and concept as a contraction of tentional - integrity. As defined by Fuller, "tensegrity defines a structural relationship principal in which structural shape is guaranteed by the finitely closed, comprehensively continuous, tentional behaviors of the system. All structures, from the solar system to the atom, properly understood, are tensegrity structures. Universe is omnidimensional integrity."

Thus, space is curved (after Einstein) because the celestial sphere is composed of the domain of the successive great circles. Universe is expanding (after Hubbel) because the tensegrity of the celestial sphere provides the ability to yield increasingly without ultimately breaking or coming apart.

In conclusion, the compound curvature geodesic structure of the celestial sphere employs the tensegrity principal and remember, the four corners of the celestial tetrahedron need to be replaced to form the tensegrity tetrahedron.

11. A MODEL

In the third degree of masonic initiation, a scene is related wherein King Solomon is apprehensive about the safety and whereabouts of his master builder, Hiram Abiff. To search for him, Solomon orders three workers to go each in the direction of the four cardinal points of universe. This allegory has always fascinated me because the three workers in the four directions (3 x 4) resembles the three vectors of restraint at the four corners of the celestial tetrahedron.

This allegory will be the working model to define and locate the four corners of the celestial tetrahedron which need to be replaced by four sets of three vectors of restraint. The "four external star foci events" are the four cardinal

points of the world referred to by all ancients. These become fixed points on the celestial tensegrity sphere which radiate three vectors each through space down to the four fixed points (signs) located in the zodiac as Leo, Taurus, Scorpio, and Aquarius.

The center ball of the tensegrity tetrahedron is replaced by the band of the zodiac, now locked in place by the twelve vectors of restraint as was the center ball in the figure on Page 13. The four cardinal points of the "world" need to be located outside the band of the zodiac, so a distinction needs to be made between the four cardinal points and the four fixed signs of the zodiac. Within the band of the zodiac is another sphere or circle of the ZOHAR, in which deity manifests logos in our world of sun, planets, moon, comets and organic life.

12. SPIRITUAL HIERARCHIES

The celestial hierarchies were first introduced to western occultism through St. Paul the apostle at the Greek school. His most intimate pupil, Dionysius the Aeropagite used the following terms in descending order from the deity: Seraphim, Cherubim, Thrones, Dominions, Might, Powers, Archai, Archangels, and Angels. The Hindu Rishis spoke of spiritual hierarchies as did the Egyptians, Chaldeans and Gnostics. Ancient wisdom named the planets not as physical globes but for the spirit which resided there. Thus, the moon (angels); Mercury (archangel); Venus (archai); sun (powers); Mars (might); Jupiter (Dominions) and Saturn (Thrones). The preceding orders relate to the planetary logos emanating through the seven planets of the ancients and do not concern us here. (The inner circle of the Zohar.)

Above the planetary spheres reside the domains of the Seraphim and Cherubim. And in the creation of Saturn (Thrones) form the triad of the first round. Rudolf Steiner explains as such in *The Spiritual Hierarchies*:

"Before a system of Thrones, Cherubim and Seraphim comes about, it must first have been a solar system. This means a sun must have reached the stage when it could unite itself again with its planets; then it can become peripheral. The sun itself becomes a zodiac. What we have come to know as the exalted beings in the zodiac are remnants that have passed over to us from a previous solar system. Seraphim, Cherubim and Thrones represent for us the highest hierarchy among divine beings because they have already accomplished this development as a solar system and have risen to an exalted rank of cosmic sacrificial service. We must picture the godhead as beyond the Seraphim. The (Seraphim) receive the plans for a new cosmic system from the divine trinity from whom they originated. The name Seraphim is always interpreted as referring to beings who receive the loftiest ideas and aims of a cosmic system from the trinity.

"The Cherubim, who belong to the next hierarchy, have the task of elaborating in wisdom the aims and ideas of received from the gods. They are capable of transporting into workable plans what is indicated by the Seraphim.

"The Thrones, the third rank of the hierarchies, have the task of putting into practice the lofty cosmic thoughts, received by the Seraphim from the gods and pondered over by the Cherubim."

The first and second threefold hierarchy is represented by Steiner as concentric circles shown in Plat No. 7.

The purpose of the first and second triad is to compress their particular sphere of influence. Cosmic bodies such as suns and planets do not simply condense, spiritual beings have to bring about the condensation, the Cherubim accomplished this task for the zodiac or animal circle.

Steiner represented this process of evolution in the following diagram Plat No. 8. The inner circle (the center ball in our tetrahedron) represents the globe of the old sun (first round). The archangels sped outward in all directions from the center globe and spread spiritually into the cosmos. The Cherubim were the beings who come to meet the archangels. "For the Cherubim, in fact, drew near, to begin with, from four sides". These four sides were the primary four sets of three vectors restraints emanating from the four corners of the celestial tetrahedron. They approached in shapes that could afterwards be represented as the four winged beasts (Ezekiel's vision) of the Bull, Eagle, Lion and Man.

For Plat No. 8, the four fixed signs of the zodiac are Leo (Lion); Scorpio (Eagle); Taurus (Bull) and Aquarius (Water-man). Notice that along side each primary Cherubim are secondary (later) zodiac signs which represents the four sets of three vectors restraints. As Steiner says:

"I have only spoken about four names of the zodiac. They represent the four principal expressions of the Cherubim, but in reality each of these cherubic beings has to the right and the left of it a kind of follower or companion. Thus we have twelvefold forces belonging to the realm of the Cherubim."

Thus, Steiner recognizes that beyond the Seraphim is the threefold trinity of deity exactly similar to our zohar model of the threefold trinity as triangle or tetrahedron. In addition, he recognizes the primary sphere, of unmanifested deity as trinity and the manifested sphere of the Seraphim as manifested deity. Or put another way, the trinity cannot manifest itself directly in our chain of worlds but can only do so in and through the manifest sphere of the Seraphim. The Seraphim and Cherubim do the work for the deity in our chain of worlds.

Steiner also recognizes the twelfold nature of the Zodiac as a result of the work of the Cherubim. This fits very neatly with our twelfold vectors of restraint manifested through the four principal expressions of the zodiac with its eight followers or companions of three zodiac signs.

Finally, the fixed signs of the zodiac represent the four places where the four sets of three vectors attach themselves tangentially to the center sphere of the celestial tetrahedron. From

the four cardinal points or "four external star foci events" emanate four sets of three vector restraints which attach tangentially to the four fixed signs of the zodiac. Thus, the four cardinal points are located (somewhere) on the surface of the celestial tensegrity geodesic sphere wholly outside the sphere of the zodiac.

As far as the order of successive chains of cosmic creation is concerned, this did not proceed progressively inward from the celestial tetrahedron. As previously stated, before a system of Seraphim, Cherubim and Thrones comes about, it must first have a solar system. The sun itself can become a zodiac, dissolve into the cosmos and become a choir of celestial beings like the Seraphim and Cherubim. For this reason, the celestial tetrahedron did not first begin as such. Through an evolution of suns and planets over four rounds only did the celestial tetrahedron become. As each successive order of spiritual hierarchies completes its assigned task, that order passes on in eternity to higher orders and is likewise replaced by similar orders evolving upwards in the spiritual hierarchy. In each of the four rounds, successive orders of the spiritual hierarchies move up and down the ladder of creation. The celestial path of the retiring Cherubim ascending as our tensional vector strings becomes the four cardinal points on the celestial geodesic sphere. The location of the four cardinal points is still a mystery to me, but I suggest the seven Rishis located in the Great Bear Constellation is one such external foci event.

13. CONCLUSION

In conclusion, our spiritual geometry evolution begins with the ZOHAR symbol of the circle with central point as here.

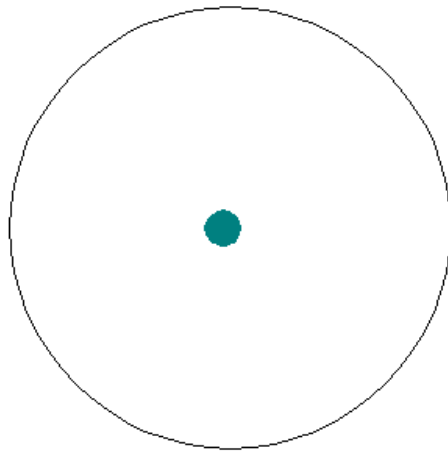

Primary first circle of god

This circle represented the outer limits of creation (the Milky Way) by the Deity as within this circumscribing circle all worlds are manifested. The central point or monad is the universal germ or seed creating the manifest worlds through the triple aspect of Deity represented by the three inscribed circles as

Later, the three circles of the Zohar are replaced by the Pythagorean triangle, with the point or monad of the tetractys as center.

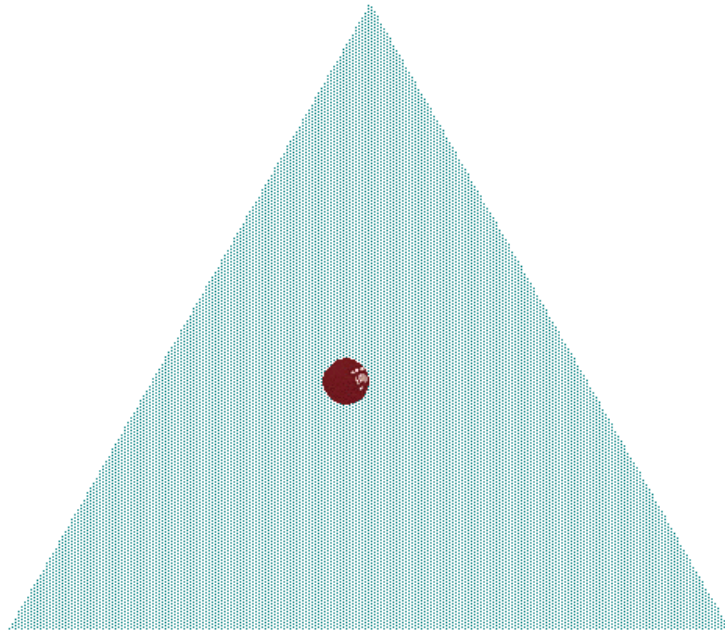

Thus, (our zohar circle) becomes the occult symbol of the circumscribed cosmos of the Milky Way, inscribed by the Pythagorean triangle and the universal seed as monad of the TETRACTYS

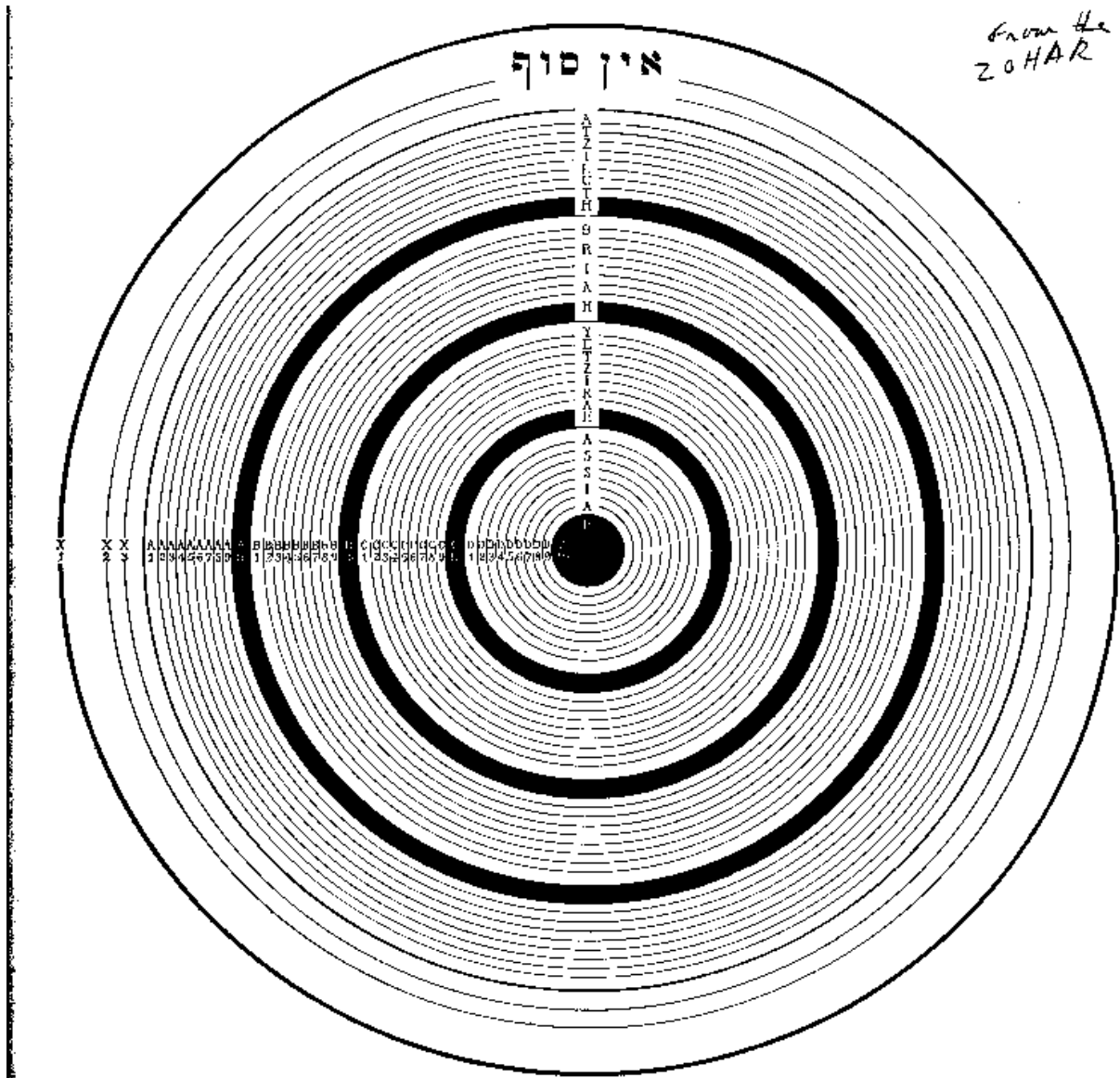

The triangle represents the forces of the Law of Three as active, passive and neutralizing, and as the three pass into four, as spirit passes into matter, the triangle becomes the tetrahedron as primary atomic event.

With the introduction of Fuller geodesics, the celestial sphere as circle is replaced with the compound curvature spherical tetrahedron. Although a good symbol, the spherical tetrahedron is not yet perfect because it is not fixed in space, it can still rotate, turbine and twist in place. In order to immobilize the tetrahedron, it is necessary to fix each of the four corners with three vectors each of restraint. This is accomplished by replacing the center point or monad with the twelvefold band of the zodiac. With each of the twelve signs of the zodiac representing a vector of restraint, the twelve respective tangents stretch from each zodiac sign to the edge of the celestial sphere, locking the system in place as a completed spherical tensegrity tetrahedron. Each of the four corners of the spherical tetrahedron are now represented in space by four star foci events whose four primary tangents run their course from the perimeter of the celestial sphere, through the spaces of the Milky Way and attach themselves to the four fixed signs of the zodiac. The result is the spiritual geometric evolution of: (1) the circle now as a celestial tensegrity sphere enclosing the Milky Way; (2) the triangle now as a tensegrity tetrahedron with four fixed corners as star foci events and (3) the central point now as the band of the zodiac with twelve vector tangents extending from the zodiac in twelve directions through space to the edge of the celestial sphere and attached at the four star foci events, locking the entire synergetic system in place, as shown in the frontispiece.

PREFACE

The law of seven shall be prefaced by that great occult principle known as the law of ANALOGY, which I refer to constantly as the law of CORRESPONDANCES. It derives from the Hermetic conclusion of the universal unity of the manifest world.

The classical formulation was set forth in the second verse of the EMERALD TABLET (in Latin, the TABULA SAMARGDINA and its Alchemical symbol) attributed to the thrice great Hermes Trismegistus, as follows:

That which is above is like to that which is below and that which is below is like to that which is above, to accomplish the miracles of the one thing.

TABULA SMARAGDINA HERMETIS.

It is true, certain, and without falsehood, that whatever is below is like that which is above; and that which is above is like that which is below: to accomplish the one wonderful work. As all things are derived from the One Only Thing, by the will and by the word of the One Only One who created it in His Mind, so all things owe their existence to this Unity by the order of Nature, and can be improved by Adaptation to that Mind.

Its Father is the Sun; its Mother is the Moon; the Wind carries it in its womb; and its nurse is the Earth. This Thing is the Father of all perfect things in the world. Its power is most perfect when it has again been changed into Earth. Separate the Earth from the Fire, the subtle from the gross, but carefully and with great judgment and skill..

It ascends from earth to heaven, and descends again, new born, to the earth, taking unto itself thereby the power of the Above and the Below. Thus the splendor of the whole world will be thine, and all darkness shall flee from thee.

This is the strongest of all powers, the Force of all forces, for it overcometh all subtle things and can penetrate all that is solid. For thus was the world created, and rare combinations, and wonders of many kinds are wrought.

Hence I am called HERMES TRISMEGISTUS, having mastered the three parts of the wisdom of the whole world. What I have to say about the masterpiece of the alchemical art, the Solar Work, is now ended.

VERBA SECRETORUM HERMETIS.



The oldest Western source for the Emerald Tablet was Albertus Magnus in the 13th. century. Later in the 15th. century, this was one of the ancient Greek texts brought by Gemistos Plethon to the Court of Cosimo de Medici for translation.

Arab sources go back to Jabir in the 9th. century and interestingly enough, another 9th. century text called the SECRET OF CREATION attributed to Apollonius of Tyana. Known to the Arabs as Balinas the Wise, this great

reformer of the ancient mystery centers was a contemporary and pole of Christ and has been said to have helped St. John write the APOCALYPSE while at the Isle of Patmos.

Nowhere is it better said about this great law than in MEDITATIONS ON THE TAROT (1985 English edition): "Since at the root of the diversity of phenomena their unity is found, in such a way that they are at one and the same time different and one, they are neither identical nor heterogeneous but are analogous in so far as they manifest their essential kinship..."

The formula of analogy applied in space is the basis of TYPOLOGICAL symbolism, that is, of symbols expressing CORRESPONDANCES between PROTOTYPES above and their manifestations below: the formula of analogy applied in time is the basis of MYTHOLOGICAL symbolism, that is, of symbols expressing correspondances between ARCHETYPES in the past and their manifestations in the present. These two categories of symbolism, based on analogy, constitute through their mutual relationship a cross".

In the next chapters, we will be dealing with the action of this law in SPACE, as topology, and not in time, as mythology. In space, this law manifests itself on levels of correspondance from the archetypal world down to the physical world. In space, this law manifests in a septenary evolution of periodicity, exoterically as sound, discoverable in the laws of music and esoterically, as light. The electromagnetic spectrum of the world ether manifests as sound and light in a broad range of sinusoidal curves. For a sine curve, in uniform motion, above the horizon is the same as below the horizon, only reversed in direction. The macrocosm above and the microcosm below. These esoteric light waves are the bearers of the activity of the Spirits of Form, also called Elohim, Exusiai or Powers, who create the forms of this manifest world.

As Goethe said in his THEORY OF COLOR,

"If only the divergence of the yellow and blue is properly grasped, and if especially the deepening into red, whereby the opposite colors lean together and unite in a third, is adequately studied, then assuredly a particularly mysterious manifestation will appear—a spiritual significance will be found underlying these two separated and opposed beings; and, if one sees them producing downwards the green and upwards the red, one can hardly refrain from thinking of the creative activity there on earth and here in heaven, of the ELOHIM"

The underlying form of the manifest world, esoterically as light from the Elohim, is reflected in the septenary of the visible spectrum, exoterically as sound, in the septenary of the musical scale. From the unity of the one, there is an evolution in space of the diffusion, thru the periodicity of the forces of the seven and the return to unity at a higher level in the twelve, the number of equilibrium. The conceptual model here is UNITY (1)--DIVERSITY (7) and a return to UNITY at a higher level (12).

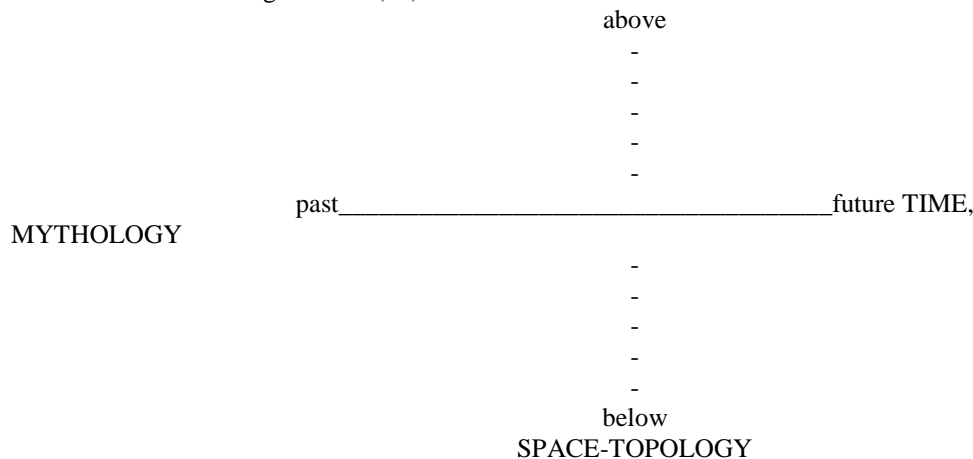

THE LAW OF SEVEN

1. Septenary in Nature

The septenary principle is observed everywhere in cosmos and is the fundamental law of Periodicity. As observed by Peter Bongus in *Mysticae Numerum Significationis* (1585):

"The number Seven,' says this learned author, has a wonderful property, for it neither begets nor is begotten, as the rest are, by any of the numbers within ten, wherefore philosophers resemble it to the ruler or governor of all things, who neither moves nor is moved. Philolaus the Pythagorean, nor ignoble author, testifies thus, and writes that the eternal God is permanent, void of motion, similar to himself, and different from others; and Boetius has a passage much to the same purpose. The idea of virginity had such a relation to the number Seven, that it was also named Pallas; and the Pythagoreans, initiated in her rites, compare the virgin Minerva to that number, seeing she was not

born, but sprung from the head of Jupiter. God rested on the Seventh day, wherefore it is named Sabbath, a word signifying rest. The Seventh petition of the Lord's Prayer is, deliver us from evil; because the number Seven denotes rest, and all evil being removed from man, he rests in good; and farther, the seventh day or sabbath represents death, or the rest of the soul from worldly labours. In Seven days after Noah entered the ark the flood began: in the Apocalypse Seven trumpets are mentioned: Job speaks of the visitation of six tribulations, which six succeeding days brought on him, but on the Seventh no harm could touch the just: God blessed only the Seventh day, wherefore the number Seven is attributed to the Holy Ghost, without whom there is no blessing. This St. John proves, when in the Apocalypse he calls the Seven horns and the Seven eyes the Seven spirits of God. The fever left the son of Regulas, according to St. John, at the Seventh hour. Elisha breathed Seven times on the dead man. Christ after his resurrection feasted with Seven disciples; and Seven brother were sent to baptise Cornelius. The Seven hairs of Sampson; Seven golden candlesticks: and in Leviticus command was given to sprinkle the blood and oil Seven times. The Seven stars in the bear; the Seven principal angels who rule the world under God, and have charge of the Seven planets, as namely, Horophiel the spirit of Saturn, Anael the spirit of Venus, Zachariel of Jupiter, Raphael of Mercury, Samael of Mars, Gabriel of the moon, and Michael the spirit of the sun. The moon changes its form Seven times, and completes its course in twenty-eight days, which is the sum of the number Seven, and all the numbers under it. Josephus writes that a certain river in Syria is dry for six days, and full on the Seventh. Farther, the great artist did not only dignify the heavens, but he also adorned with the number Seven his favourite creature man, who has seven inward parts, or bowels, stomach, heart, lungs, milt, liver, reins, and bladder; and seven exterior, as head, back, belly, two hands, and two feet. There are seven object of sight, as body, distance, figure, magnitude, colour, motion, and rest: and Seven species of colour, taking the two extremes of white and black, viz., yellow, sky-blue, green purple, and red. No one can without eating live after the Seventh day. Physicians reckon ten times Seven years to be the period of human life, which Hippocrates divides into Seven stages. The ancient lyre, used both by Orpheus and Amphion, had only Seven chords, answering, as it is said, to the Seven gates of Thebes. Every Seventh daughter, no son coming between, hath, by virtue of the number Seven as I imagine, a great power in easing the pains of child-birth: and every Seventh son, no daughter coming between, has the power of curing the scurvy and leprosy by the bare touch; so that diseases, incurable by physicians, are curable by the virtue contained in the number Seven. A right-angled triangle is constituted of the sides three, four, five, but three and four contain the right angle, which is perfection itself, and therefore their sum seven, must as a number be most perfect. Every active body has three dimensions, length, breadth, and thickness, and these have four extremes, point, line, surface, and solid, and these together make up the number Seven.

Gurdjieff was the first occultist to call the septenary principle, the Law of Seven. I have never seen the principle better explained than by him. (From *In Search of the Miraculous*).

"The next fundamental law of the universe is the law of seven or the law of octaves.

"In order to understand the meaning of this law it is necessary to regard the universe as consisting of vibrations. These vibrations proceed in all kinds, aspects, and densities of the matter which constitutes the universe, from the finest to the coarsest; they issue from various sources and proceed in various directions, crossing one another, colliding, strengthening, weakening, arresting one another, and so on.

"The principle of the discontinuity of vibration means the definite and necessary characteristic of all vibrations in nature, whether ascending or descending, to develop not uniformly but with periodical accelerations and retardations. This principle can be formulated still more precisely if we say that the force of the original impulse in vibrations does not act uniformly but, as it were, becomes alternately stronger and weaker. The force of the impulse acts without changing its nature and vibrations develop in a regular way only for a certain time which is determined by the nature of the impulse, the medium, the conditions, and so forth. But at a certain moment a kind of change takes place in it and the vibrations, so to speak, cease to obey it and for a short time they slow down and to a certain extent change their nature or direction; for example, ascending vibrations at a certain moment begin to ascend more slowly, and descending vibrations begin to descend more slowly. After this temporary retardation, both in ascending and descending, the vibrations again enter the former channel and for a certain time ascend or descend uniformly up to a certain moment when a check in their development again takes place. In this connection it is significant that the periods of uniform action of the momentum are not equal and that the moments of retardation of the vibrations are not symmetrical. One period is shorter, the other is longer.

"In order to determine these moments of retardation, or rather, the checks in the ascent and descent of vibrations, the lines of development of vibrations are divided into periods corresponding to the doubling or the halving of the number of vibrations in a given space of time.

"Let us imagine a line of increasing vibrations. Let us take them at the moment when they are vibrating at the rate of one thousand a second. After a certain time the number of vibrations is doubled, that is, reaches two thousand.

"It has been found and established that in this interval of vibrations, between the given number of vibrations and a number twice as large, there are two places where a retardation in the increase of vibrations takes place. One is near the beginning but not at the beginning itself. The other occurs almost at the end.

"The laws which govern the retardation or the deflection of vibrations from their primary direction were known to ancient science. These laws were duly incorporated into a particular formula or diagram which has been preserved up to our times. In this formula the period in which vibrations are doubled was divided into eight unequal steps corresponding to the rate of increase in the vibrations. The eighth step repeats the first step with double the number of vibrations. This period of the doubling of the vibrations, or the line of the development of vibrations, between a given number of vibrations and double that number, is called an octave, that is to say, composed of eight.

"In the guise of this formula ideas of the octave have been handed down from teacher to pupil, from one school to another.

"The seven-tone scale is the formula of a cosmic law which was worked out by ancient schools and applied to music.

"A study of the structure of the seven-tone musical scale gives a very good foundation for understanding the cosmic law of octaves.

"Let us again take the ascending octave, that is, the octave in which the frequency of vibrations increases. Let us suppose that this octave begins with one thousand vibrations a second. Let us designate these thousand vibrations by the note do. Vibrations are growing, that is, their frequency is increasing. At the point where they reach two thousand vibrations a second there will be a second do, that is, the do of the next octave.

"The period between one do and the next, that is, an octave, is divided into seven-unequal parts because the frequency of vibrations does not increase uniformly.

"The ratio of the pitch of the notes, or of the frequency of vibrations will be as follows:

"If we take do as 1 then re will be $9/8$, mi $5/4$, fa $4/3$, sol $3/2$, la $5/3$, si $15/8$, and do 2.

"The differences in the acceleration or increase in the notes or the difference in tone will be as follows:

between do and re $9/8 : 1 = 9/8$

between re and mi $5/4 : 9/8 = 10/9$

between mi and fa $4/3 : 5/4 = 16/15$ increase retarded

between fa and sol $3/2 : 4/3 = 9/8$

between sol and la $5/3 : 3/2 = 10/9$

between la and si $15/8 : 5/3 = 9/8$

between si and do 2 : $15/8 = 16/15$ increase

again retarded

"The differences in the notes or the differences in the pitch of the notes are called intervals. We see that there are three kinds of intervals in the octave: $9/8$, $10/9$, and $16/15$, which in whole numbers correspond to 405, 400, and 384. The smallest interval $16/15$ occurs between mi and fa and between si and do. These are precisely the places of retardation in the octave.

"In relation to the musical (seven-tone) scale it is generally considered (theoretically) that there are two semitones between each two notes, with the exception of the intervals mi-fa and si-do, which have only one semi-tone and in which one semitone is regarded as being left out.

"In this manner twenty notes are obtained, eight of which are fundamental:

do, re, mi, fa, sol, la, si, do

and twelve intermediate: two between each of the following two notes:

do-re

re-mi

fa-sol

sol-la

la-si

and one between each of the following two notes:

mi-fa

si-do

"But in practice, that is, in music, instead of twelve intermediate semi-tones only five are taken, that is one semitone between:

do-re

re-mi

fa-sol

sol-la

la-si

"Between mi and fa and between si and do the semitone is not taken at all.

"In this way the structure of the musical seven-tone scale gives a scheme of the cosmic law of 'intervals,' or absent semitones. In this respect when octaves are spoken of in a 'cosmic' or in a 'mechanical' sense, only those intervals between mi-fa and si-do are called 'intervals.'

"What precisely does happen at the moment of the retardation of vibrations? A deviation from the original direction takes place.

"All this and many other things can be explained with the help of the law of octaves together with an understanding of the role and significance of 'intervals' which cause the line of the development of force constantly to change, to go in a broken line, to turn round, to become its 'own opposite' and so on.

"Such a course of things, that is, a change of direction, we can observe, in everything.

"The law of octaves explains many phenomena in our lives which are incomprehensible.

"First is the principle of the deviation of forces.

"Second is the fact that nothing in the world stays in the same place, or remains what it was, everything moves, everything is going somewhere, is changing, and inevitably either develops or goes down, weakens or degenerates, that is to say, it moves along either an ascending or a descending line of octaves.

"And third, that in the actual development itself of both ascending and descending octaves, fluctuations, rises and falls are constantly taking place."

The laws of music are a mathematical analysis of the laws of vibrations. Modern science says that energy is matter moving at a vibration rate of the velocity of light squared. Thus, a study of music is the study of the universe of vibrations. The esoteric study of music is the law of seven consisting of tones, semi-tones, and absent semi-tones or intervals.

In this explanation of the esoteric law, Gurdjieff also states (about year 1915) that this law is everywhere the same and that light, heat, chemical, magnetic and other vibrations are subject to the law of seven. Has this esoteric observation been proved correct by modern science?

For example, look at the visible light spectrum seen through the dispersing prism of Sir Newton. The prism deflects the seven colors of red, orange, yellow, green, blue, indigo and violet. Newton, himself, observed the correlation between the musical scale and the visible light spectrum. but, he went no further in exoteric publication than his Optics.

Taking a typical base note such as a C, the ratios of the frequencies of D, E, F, etc., may be taken in the musical scale (first formulated by Pythagoras) as set forth above as 9:8, 5:4, 4:3, etc. The correspondence between the visible light scale and the musical scale is as set forth below:

Using C as a base note of DO, the Pythagorean musical ratios produce the visible light spectrum.

	1 : 1	Cycle / Sound	
Do - C		4.40 x 10 ⁴	Red
Re - D	9 : 8	4.95 x 10 ⁴	Orange
Mi - E	5 : 4	5.5 x 10 ⁴	Yellow
Fa - F	4 : 3	5.86 x 10 ⁴	Green
Sol- G	3 : 2	6.60 x 10 ⁴	Blue
La - A	5 : 3	7.33 x 10 ⁴	Indigo
Ti - B	15 : 8	8.25 x 10 ⁴	Violet
Do	2 : 1		Invisible

One should observe that the correspondence holds up quite well. If valid for the visible light spectrum, the correspondence should also hold up for the non-visible electromagnetic spectrum from gamma rays to radio waves. In fact, ours is a cosmos of radiation, the lengths of its waves continuously varying in length from very short (gamma) to very long (radio). However, radiation is not distributed continuously in a given region, but is concentrated into pellets called photons which have both wave and particle properties. Until the discovery of the prism by (Newton), our science did not conceive of visible light consisting of seven independent wave lengths of light, which in unity is white light. However, the occult scientists did and this correspondence is reflected in the seven notes of the musical scale.

Another example of the correspondence of the septenary principle is in the atomic world of the chemical elements. Each atom is enclosed, like the layers of an onion, with SEVEN electron shells. As each successive shell fills with free electrons, the chemical properties of the elements depend upon the number of electrons in the outermost shell available for the chemical bonds.

In addition, the chemical elements show a septenary relation in the periodic table of Mendeleev (1869). As observed several years earlier in 1864 by J. Newlands, "the difference between the number of the lowest member of a group (of the periodic table) and that immediately above it is 7; in other words, the eighth element starting from a given one is a kind of repetition of the first, like the eighth note of an octave in music". So close yet so far.

Going beyond the atomic world of correspondence to the molecular world of correspondence, we again find the septenary principle evident in the mineral kingdom of nature. Crystals are a three dimensional periodic arrangement of atoms in molecular form dispersed symmetrically at a given point of space. There are 230 possible space groups of three dimensional crystal structure in symmetry. This number of total possible arrangements in space can be reduced to thirty-two crystal classes, which consists of structural forms such as prism, pyramid, dome, cube, octahedron, dodecahedron, etc. All crystal classes can be further reduced to SEVEN crystal systems which contain all crystal classes as follows:

Isometric 5 classes
Tetragonal 7 classes
Hexagonal 7 classes
Trigonal 5 classes
Orthorhombic 3 classes
monoclinic 3 classes
triclinic 2 classes
32 crystal classes

Thus, the shape and structure of our solid earth shows a septenary periodicity. The universality of the law of seven shows itself in the vibrations of visible light, the invisible light of the electromagnetic spectrum, sound, color, atomic world of chemical elements, periodic table of chemical elements and molecular world of mineral structure. The number of correspondence is as infinite as the cosmos itself and unimportant. What is important is to see this principle at work, in everything around us in the manifested world, unlike the law of three which operates in the first instance in the unmanifested world and is more difficult to recognize.

2. SEPTENARY IN MAN

If there is any gnosis that a human should depart with in death from this planet, none is more important than the principle of the law of seven as applied to man.

The Madame H.P.B. in the Secret Doctrine shows beyond a doubt the septenary in man is a fundamental esoteric doctrine of antiquity.

The Egyptians divided the sky by night into seven parts, the heaven into seven parts, the forces of nature into seven parts, the invisible forces of nature into seven elementals and also, seven elements or souls to man (from Gerald Massey).

1. KHAT - body
2. BA - soul of breath
3. KHABA - the shade
4. AKHU - intelligence or perception
5. SEB - ancestral soul
6. PUTAH - first intellectual father
7. ATMU - divine or eternal soul

Another esoteric division given by H.P.B. is by F. Lambert (1887) and taken from hieroglyphics and The Egyptian Book of the Dead:

1. KHAT - physical body
2. ANKH - vital force
3. KA - astral body - sidereal man
4. ABHATY - animal soul - heart
5. BA - intellectual soul - intelligence
6. KHAIBIT - spiritual soul
7. KHU - divine spirit

In reference to the Persian-Zoroastrian cultural epoch and system of knowledge, an article appeared in the early Theosophist, reprinted in Five Years of Theosophy setting forth the seven principles in their man as follows:

1. TANWAS - body
2. USHTANAS - vital force
3. KEHERAS - aerial form
4. TEVISHIS - will, sentient consciousness
5. BOADHAS - animal soul

6. VRWANEM - soul, that is judged often death

7. FRAWASHEM - spirit - divinity

The source is taken from the holy hymn book Avesta whose initiates were called the Magi.

A footnote in the article is written by the editors declares that the ancient Chinese text I Ching written some 1,200 years B.C. also references a septenary nature in man as follows:

1. KWEI

2. SHAN

3. KWEI SHAN

4. ZHING

5. PHO

6. KHI

7. HWUN

With the founding of the Theosophical Society in 1875, the occult doctrines of the Buddhist and Hindu East began to be published in the English language for the first time. Madame H.P.B. as messenger of the trans-Himalayan Arhats decided it was the time in the Kaliyuga cycle to make exoteric many of the former esoteric tenants of the Secret Doctrine.

This disclosure was desperately needed because western occultism suffered from schism and persecution from the Catholic Church since the beginning of the Christian Councils in the third century. The essences were exterminated by the Romans the school and library of Alexandria after repeated razing, met its final demise in the year 641 by the Calif Omar. The only remains of the Gnostics is the Pistis Sophia. The Cathars burned at the stake by the Albigensian Crusade and the Knights Templar burned at the stake by King Philip of France. After the horrible death of Jacques de Molay in year 1314, the Temple of Solomon was finally destroyed and western occultists went underground. The medieval Kabbalists and Alchemists, the esoteric Christian Rosicrucians and the masonic lodges were all secret organizations hiding from the torture, vivisection and death by the Church. When these groups did go exoteric, only a shell remained of their spiritual impulse and their revealed knowledge was in symbolic or mandala form, inaccessible to the common man. Thank God and not the Church for the spiritual revival lead by the Theosophical Society of the Nineteenth Century.

First in the series of disclosures of the ARHAT doctrines was A.P. Sinnett's book Esoteric Buddhism which set forth the principles as follows:

1. Body - RUPA

2. Vitality - PRANA or JIVA

3. Astral Body - LINGA SARIRA

4. Animal Soul - KAMA RUPA

5. Human Soul - MANAS

6. Spiritual Soul - BUDDHI

7. Universal Spirit - ATMA

This division separates the seven principles into a lower quaternary which function on the astral and physical planes and a higher triad of undeveloped principles representing the future evolution of spirit in mankind. As explained by Sinnett, the second principle of man, vitality, consists of Prana or life force as matter in its aspect as force. Bury the body after death, and its Jiva will attach itself to the vegetation which springs above or the lower animal forms which evolves from its substance. Burn the body, and indestructible Jiva flies back to the planet itself from which it was originally borrowed.

The astral body is the etheric duplicate of the physical body, a sort of original design or template for organic development and differentiation. It never leaves the body except at death when it is disembodied for several days, and disperses into the astral world.

The forth principle is translated as the body of desire in its earthly aspect and vehicle of will in its spiritual aspect. Traditionally, this principle was the animal soul as seat of animal desires which include the whole range of human passions and was the last earthly principle.

Starting with the fifth principle, we see the first of the spiritual qualities in man which are not yet fully developed.

This human soul is the seat of mind or intelligence. Sinnett relates the sixth principle is still in embryo and the seventh principle is the spark of the divine or god in all of us, which is the same for all humanity. The sixth principle may be called the vehicle of the seventh as well as the fourth principle is the vehicle of the fifth.

Sinnett goes the further step in declaring that all principles, even the three finer spiritual principles "are material and molecular in their constitution." Unknown to him at the time, this was probably his greatest achievement when this book hit the bookstands in Europe. Every spiritualists came out of the closet and decried him the ultimate "materialist". Of course, this declaration is exactly the same as that of Gurdjieff when 40 years later he said that

"Everything in the universe can be weighed and measured. The absolute is as material, as weighable and measurable, as the moon or as man. If the absolute is God, it means that God can be weighed and measured." Thus, a great debate ensued which only helped the cause of revealing more esoteric doctrine to mankind.

R. Steiner did a series of lectures in 1915 later published as *The Occult Movement in the Nineteenth Century* in which he calls Sinnett "a journalist whose brain tended entirely to materialism" and that Madame H.P.B. "had been driven into the one-sided sphere of left-wing Indian occultists." In these lectures, R. Steiner correctly declares that the teachings of repeated earth-lives, a basic tenant of Buddhist and Brahman theology of karma and reincarnation, has been deliberately withheld from Christian esoteric teachings. Likewise, the teachings of the septenary nature of man been intentionally withheld from Christian sources. This is because the doctrine of the septenary nature of man pre-supposes a life after death, an ascent through the spiritual worlds to cleanse the palate of animal desires and sins, a re-birth on earth as a human to forward the evolution of the three higher principles of mankind towards spiritual perfection and ultimate union with the seventh principle, Atma.

Steiner as a Christian esotericist made a deliberate attempt to unite Eastern teachings about incarnation and karma into Christian occult theology. His septenary elements of the man is as follows:

1. Physical body
2. Etheric Body
3. Astral Body
4. Ego (thinking, willing and feeling)
5. Spirit - Self (Manas)
6. Life - Spirit (Buddhi)
7. Spirit - Man (Atma)

Please note the two changes from the Eastern occult set forth by Sinnett and the Theosophists. First, Steiner re-names the higher triad according to his spiritual science doctrine of Anthroposophy. For the years 1902 from 1913, Steiner was the head of the German Chapter of the Theosophical Society in Europe. During these years he gave thousands of public lectures using the Theosophical terminology of Manas-Buddhi and Atma for the higher triad. However, he was fired by Annie Besant, the head of the Theosophical Society which maintained its headquarters in Adyar, India to preserve its Eastern influence, which Steiner was trying to unite into an East-West occult theology. In addition, Steiner flatly rejected the contention of A. Besant and C.W. Leadbeater for the Theosophical Society that a young Indian boy named Krishnamurti would bear the reincarnation of Jesus Christ at the end of the second millennium, an event more than one religious group expected. In the end, Krishnamurti rejected the mantle of Christ consciousness and Steiner's rejection proved valid. However, after leaving the Theosophical Society, he founded his own Western version called Anthroposophy. It was probably in an effort to distinguish his Anthroposophic group from the Theosophic group, that he changed the traditional Eastern occult terms for the higher triad.

Second, he drops the traditional Eastern occult name for the fourth principle - Kamarupa or animal soul and substitutes the term Ego. He further attributes to the ego the functions of kama rupa as thinking - willing - feeling. This was a good change so as to eliminate the controversy and confusion existing over the fourth principle in dealing with higher and lower manas (mind) and calling as Sinnett did, the fourth principle as vehicle of the fifth (manas). Now, for Western occultism, the fourth principle is simply the human I or ego in its three animal soul functions of thinking (mind), feeling (emotions) and willing (desire) or the three soul forces in which the ego emerges, sentient soul, mind soul and consciousness soul.

Lastly, Steiner names the second principle the etheric body, a term which has taken hold in the Twentieth Century to distinguish the life body, etheric double from the astral body or body of animal desires. Sinnett often confused the astral body with the etheric double.

Personally my classification of the septenary principles would name the lower quaternary from Steiner as physical, etheric, astral and ego and keep the Eastern occult terms for the higher triad as Manas, Buddhi and Atma. This blends East and West occult terminology and since so much more is written about the three higher principles in the East than the West, keeping the Eastern terms allows one when studying the higher principles to have consistent terminology.

Steiner described the higher triad as follows:

"We have often mentioned that today man consists of four members - physical, etheric and astral bodies, and an "I" or ego. This is the key to all spiritual science. We also know about man's future development, how the "I" working from within gradually transforms the astral body so that it finally gains complete mastery over it. When the astral body has been thus transformed, we say that it contains Spirit Self or Manas. An astral body ruled by the ego is the Spirit Self or Manas. The same applies to the ether body. When the ego works still more powerfully, it can overcome the opposing forces of the ether body. The transformed ether body then becomes Life Spirit or Buddhi. Finally, when the ego gains mastery over the physical body, when the most powerfully opposing forces of the

physical body are also overcome, man bears in him Spirit Man or Atman. Thus, in transforming his physical body into Atman or Spirit Man, he becomes sevenfold. Outwardly, the physical body appears as a physical body, but inwardly it is completely controlled and permeated by the ego. At this stage, the physical body is both physical body and Atman. The ether body is both ether body and Life Spirit or Buddhi, and the astral body is both astral body and Spirit Self or Manas. The ego has now become ruler of the other members. Thus, man evolves to higher stages of development out of his own forces. He strives toward his own deification, as Dionysius the Areopagite, the friend and pupil of St. Paul, called it."

3. SEPTENARY IN THE AGES AND EPOCHS OF MANKIND

Astronomical Ages

Cosmic Christianity demands knowledge of the evolutionary ages and epochs of mankind which in Christian tradition is reflected in the APOCALYPSE OF ST. JOHN. First, we must distinguish between ages and epochs. An astronomical age is determined by the vernal point of the sun in the plane of the sidereal zodiac. What the ancients called the "great Platonic year" is now called the precession of the equinoxes caused by the wobble of the earth's axis due to the gravitational pull of the sun and moon.

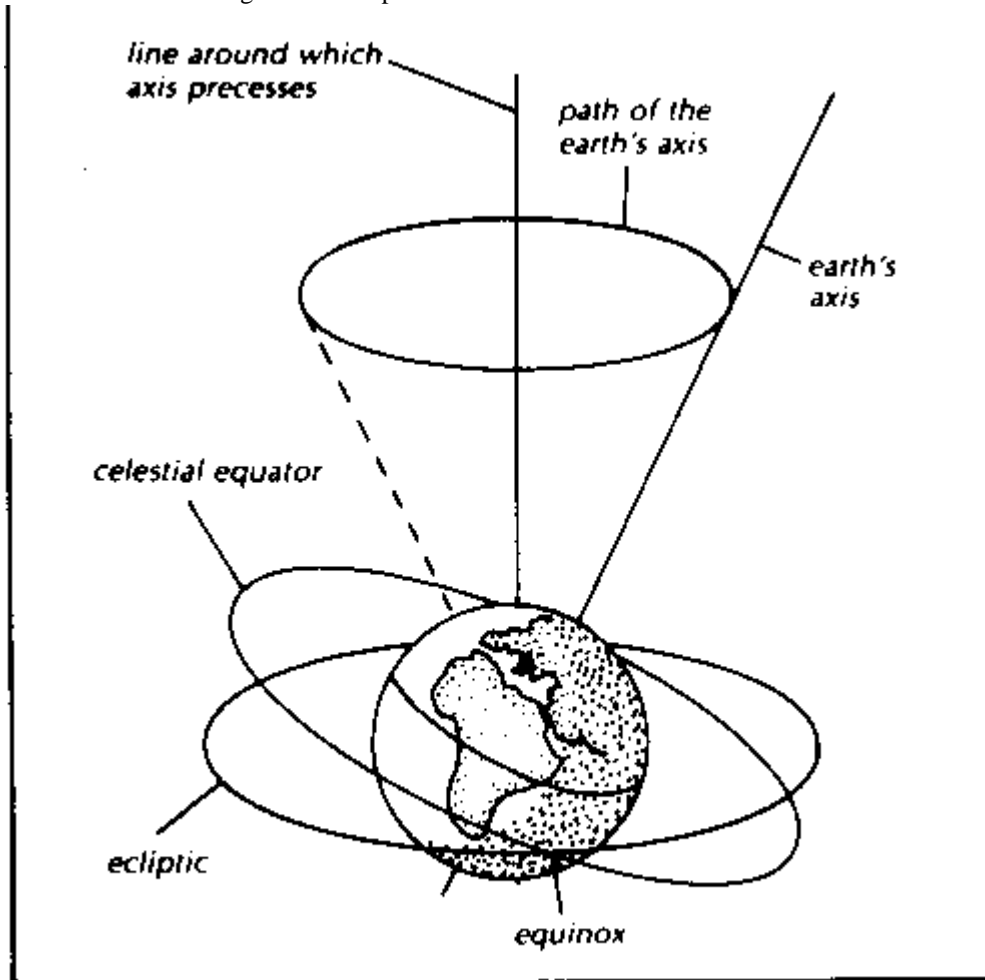

5.3 The precession of the equinoxes.

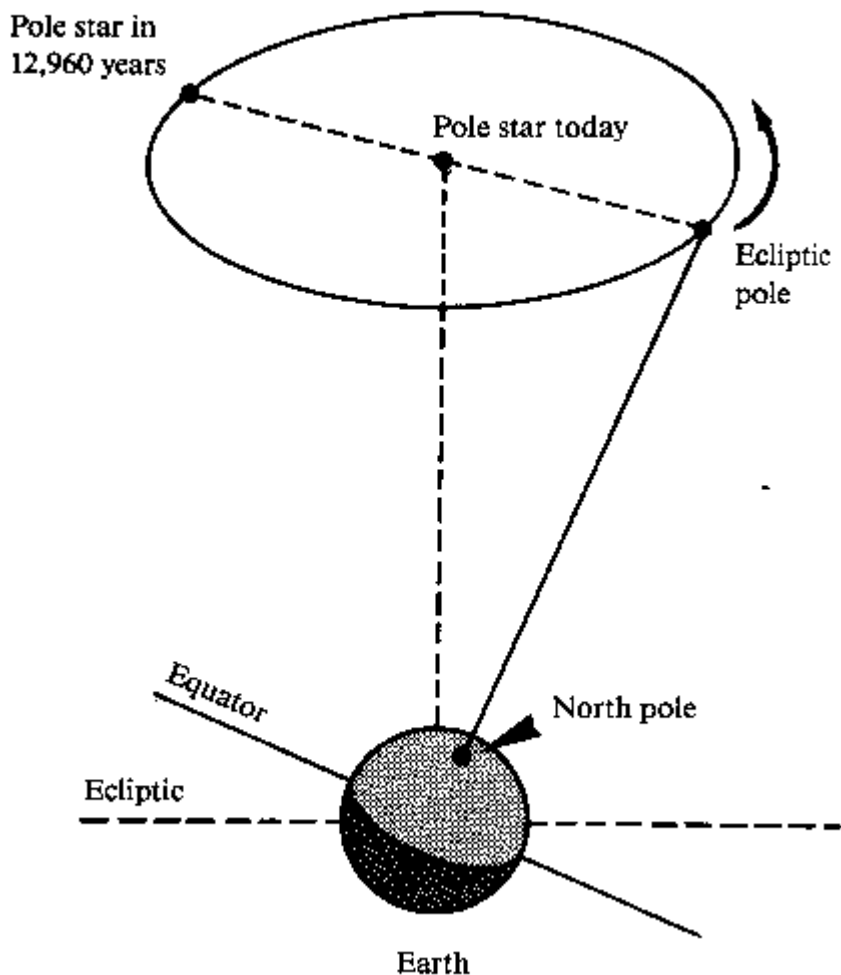

The length of this solar sidereal year was also determined by the ancients and even today is determined to be 25,920 years. While there is an apparent eastward movement of the sun thru the plane of the houses of the zodiac over the course of a tropical solar year, there is also a reverse, precessional motion of the sun thru the sidereal zodiac over the course of 25,920 years. The vernal point is the location of the sun in the sidereal zodiac on the day of the spring equinox. Our present tropical calendar and zodiac places this as 1 degree Aries, when in fact, due to the precession, every 72 years it is 1 degree backwards in the zodiac. As of February 10, 1983, the longitude of the vernal point was exactly 5 1/2 degrees Pisces in the sidereal zodiac. For this reason, we live in the ASTRONOMICAL AGE of Pisces. Now, an astrological age is different from the above astronomical age. The modern calendar sets the vernal equinox to begin on March 21 concordant with the astrological month of Aries. How did we get into this mess where the astronomical vernal equinox on March 21st is actually 5 1/2 degrees Pisces, but when you look at your calendar or have your horoscope cast, the first day of spring is 1 degree Aries? Historically, there were two important changes made to our calendar which then was in more confusion than the tongues of Babel.

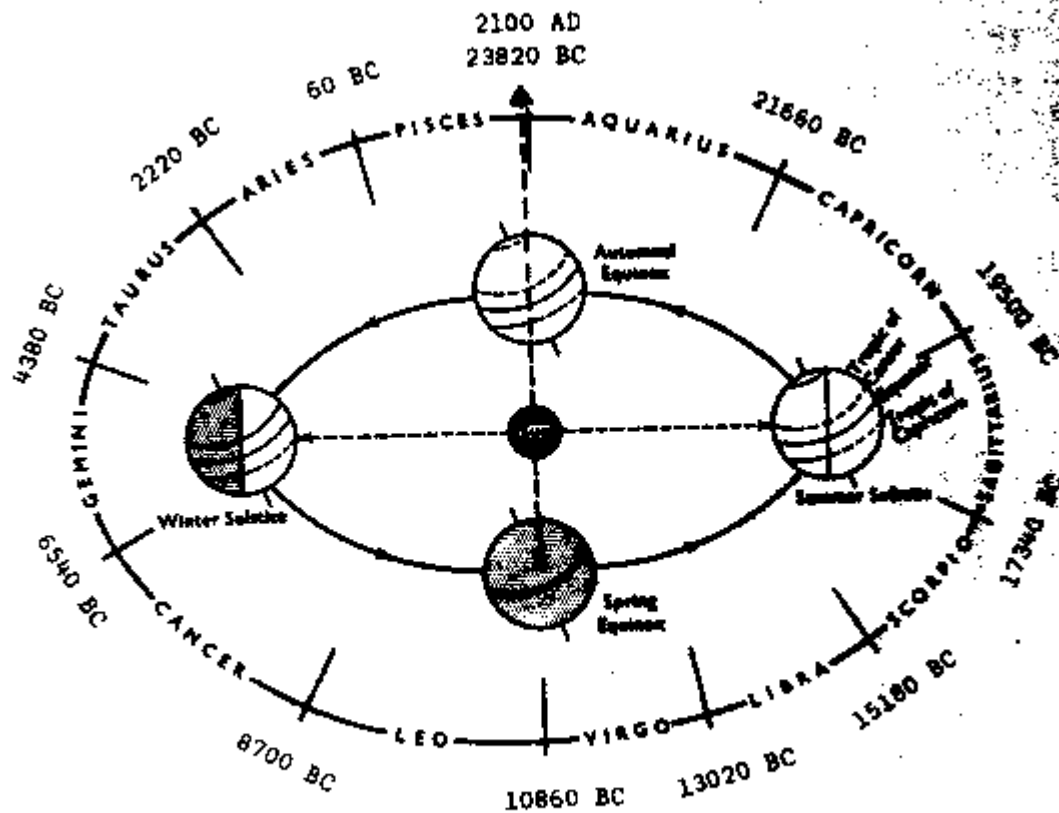

Fig. 98

Every culture had their own personal system to begin the new year and all nations, except for the Essenes, used a lunar calendar consisting of 13 months and between 354 and 364 days. Enter Julius Caesar. With the help of an initiate named Sosigenes, the first calendar reformed occurred. Taking the year 47 BC, at which time our January 1st would have fallen on October 13, he inserted two new months of 33 and 34 days between November and December. Then, he added an intercalary period of 23 days near February for a total length of 445 days. Macrobius called this long year, the last year of confusion. Beginning the next year, he started a new year of 365 days with a leap year every fourth year of 366 days. Had he asked, or maybe Sosigenes told him, but he could not wait, the Ancient Wisdom would have told him to begin the new year at a new moon on an equinox or solstice. Julius did get one-half of it right. In 45 BC, the new moon occurred 7 days after the December 24th solstice, so he made December to have 30 days, and began the new year 7 days later on what he called the calends of January. Of course, it would have been better to have waited until a new moon coincided with the winter solstice, but that is how the new year begins on January 1st. Caesar harmonized the seasons with the calendar, so that winter was again under the signs of Capricorn and Aquarius, except for the precession which no one then would have noticed. Now the Julian year had 12 months, to which he assigned 30 days to even months and 31 days to odd months, with the exception of February, which had 29 days. Not to be outdone by his father, for whom the month of July was named, Augustus later renamed August and stole one day from February to give himself a 31 day immortal honor. Since the Julian calendar is 11 minutes and 14 seconds longer than the tropical year of the seasons, by 1583 the year was about 10 days behind the seasons (one day in 128 years). Pope Gregory XIII introduced a reform to delete a leap year every century mark except the fourth. The second change occurred at that famous Council of Nicea held in 325 AD by Constantine the Great. Then the good church fathers decreed that the months be forever fixed, so that on whatever day the vernal equinox occurred, it would arbitrarily be called March 21st and the remainder of the year to adjust accordingly. Since then, instead of the equinoctial point moving steadily thru one month to another to reflect the precession, the first day of spring and Aries is fixed and the months move slowly away backwards.

With the calendar now adjusted for a fixed tropical year, we can look at the remainder of the great cycle upon which all occult time is reckoned. The actual rate of precession is equal to 1 degree every 72 years or according to Newcomb in 1925, 50.2610" per year. Therefore, at this precessional rate, the sun travels westward thru an entire sidereal zodiac house (30 degrees X 72) every 2,160 years.

The total precessional cycle of the great solar sidereal year is fixed at 25,920 years. However, the inferior cycles of 2,160 years are uneven and unequal in duration and length. For example, the actual length of the stars from one end of the constellation to the other in Pisces is 34 degrees and its duration will be 2,592 years. For the constellation of Aquarius, the length is 26 degrees, and the duration is 1,872 years. In addition, because of Kepler's laws of planetary motion, the actual rate of motion also varies, so at the present time, the precessional rate is closer to 71 1/2 years. For these reasons, occultists use an average rate of 1 degree for 72 years and an average length of 30 degrees per zodiacal house. Thus, an average astronomical age is set at 2,160 years, even though the individual length and rate varies considerably.

To determine when the age of Pisces will precess into the age of Aquarius, simply multiply 5 1/2 degrees by 72 years and add (396) to the last determined year of 1983. Thus, the "Dawning of the age of Aquarius" begins about year 2379, further in the future than many new age morons predict. Likewise, subtracting 2,160 years from the end year, we arrive at the beginning of the age of Pisces at year 219 AD. By extrapolation, we can determine the astronomical ages for the five sub-races of the Fifth Aryan root race as follows (taken from Robert Powell):

Cancer	8426 to 6266 BC
Gemini	6266 to 4106 BC
Taurus	4106 to 1946 BC
Aries	1946 BC to 215 AD
Pisces	215 AD to 2379 AD
Aquarius	2379 to 4535 AD

Likewise, we can also extrapolate the astronomical ages for the seven sub-races of the Fourth Atlantean Root Race as follows:

Aquarius	23,546 to 21,386 BC
Capricorn	21,386 to 19,226 BC
Sagittarius	19,226 to 17,066 BC
Scorpio	17,066 to 14,906 BC
Libra	14,906 to 12,746 BC
Virgo	12,476 to 10,586 BC
Leo	10,586 to 8,426 BC

CULTURAL EPOCHS

The Ancient wisdom referred to these inferior precessional cycles as the "Religious Ages of Mankind" knowing the hermetic axiom that "as above, so below" reflected a succession of cosmic evolution unfolding in cycles upon historical evolution. However, although the astronomical ages ran parallel to the religious ages, they do not run coincident in time with them. This lack of synchronicity has always been a problem to occultists who decipher the symbols of a particular age, but can not place the age in historical astronomical time.

For me, I always had the problem when, for example, Dr. Steiner places the age of Pisces beginning at year 1413 AD, when I know the astronomical age actually began around year 215. It is so remarkable that even our legacy of tropical astrologists can not determine the dates of the astronomical ages, by simple calculation. It seems every tropical astrologist has his own date for the age of Aquarius. One problem stems from the fact that to get the determination of the February 10, 1983 Ephemeris, it is necessary to have a perfect alignment of the earth, sun and a fixed star on the ecliptic, which does not often occur.

Ptolemy in his ALMAGEST, recognized the year 747 BC as the historical date of recorded astronomical and chronological time (from King Nabonassar of Babylon). This year coincides with the historical founding date of the city of Rome, whence began the reign of the 7 kings. It is also recognized occultly as the beginning of the religious age of Aries. However, the astronomical age of Aries actually begins at year 1946 BC - a difference of 1199 years.

The Ancient Wisdom recognized that a change from one precessional cycle to another reflected a change of consciousness from one level to another. The creative hierarchies located in each of the constellations pour forth spiritual impulses to guide humanity and to commence such a new age, give birth to an avatar, manu, messiah or Naros. The solution to this problem of the time lag between astronomical ages and CULTURAL EPOCHS (n/f religious ages) was exoterically revealed by Robert Powell in his book HERMETIC ASTROLOGY VOL I (1987) where he says:

"The period of rotation of the Venus Pentagram around the sidereal zodiac is 1199 years. Like the motion of the vernal point, the rotation of the Venus Pentagram is backwards, it regresses through the sidereal zodiac. In the length

of time it takes for a complete cycle of the precession of the equinoxes through the sidereal zodiac (25,920 years), the Venus Pentagram makes some 21 1/2 rotations (21.5 X 1199 = 25,778.5 years). The ratio of the cycle of the Venus Pentagram (1199) to that of the precession of the equinoxes (25,920) is a little less than the ratio of one to twenty-four, which is the ratio of one hour to one day. If the complete precession cycle is likened to a "world day", then the rotation of the Venus pentagram is like the passage of a "world Hour." When a new astrological age starts, signified by the entrance of the vernal point into a new sign of the zodiac, a world hour still elapses before the new zodiacal impulse begins to register as a cultural phenomenon, and this lapse of time is measured by the rotation of the Venus Pentagram. A new impulse starts to work on a spiritual level as soon as the vernal point enters a new zodiacal sign, but it has to filter through from cosmic realms...The Venus Pentagram acts as a kind of cosmic transformer, stepping down the cosmic impulse, which operates on a very high level, a religious level, to become a social impulse, which works on a more human level."

That being very well expressed, Dr. Steiner has given us numerous lectures on the exact dates of the cultural epochs for the five Post-Atlantean civilizations as follows:

1. Cancer	7227 BC	Hindu/Indian
2. Gemini	5067 BC	Persian
3. Taurus	2907 BC	Egyptian/Chaldean
4. Aries	747 BC	Greek/Roman
5. Pisces	1414 AD	European

Going backwards in time to the Atlantean age, an issue arises over whether or not a pralaya occurs between each successive root race. It would seem logical to me that each successive root race age would contain 7 active and 5 inactive (rest) inferior cycles of 2,160 years to balance out a great solar sidereal year of 25,920 years. In this way each Root Race would be complemented by a complete turn of the earth's axis around the polar star. Also, we will learn from the Law of Twelve that the 7 (manifest) and 5 (hidden) completes a complete cycle between two adjoining cosmos.

However, Dr. Steiner in his lectures entitled ANCIENT MYTHS (1918), draws a parallel between the seventh sub-race of Lemuria and the present fifth sub-race (our own) of the Aryan root race. He says that twelve cultural epochs ago, the sun was also in Pisces. To get back there from here, he drew a continuous line of successive cultural epochs, beginning with four from our age, seven from the Atlantean age and one from Lemuria, twelve in all. Thus, from his spiritual investigation of the Akashic record, he found no discontinuity or pralaya between the ages.

In fact Spiritual Science teaches that a long pralaya occurs after a manvantara, the seven days and five nights of Brahma, and a short pralaya occurs after each successive globe or (Christian) kingdom. thus, globes, ages and epochs draw no pralaya. During our fourth manvantara of earth evolution, the 7 globes pass thru 7 Root Race ages thru 7 cultural epochs for a total of 343 Conditions of Form, all without interruption of pralaya.

This being diagnosed, we can extrapolate the exact dates for the cultural epochs of the Fourth Atlantean Root Race as follows:

1. Rmoahals	22,347 BC	Aquarius
2. Tlavathis	20187 BC	Capricorn
3. Toltecs	18027 BC	Sagittarius
4. Turanians	15876 BC	Scorpio
5. Semites	13707 BC	Libra
6. Accadians	11547 BC	Virgo
7. Mongolians	9387 BC	Leo

The Biblical Flood

In addition, we can extrapolate the Lemurian third root race as beginning about 37,467 BC and ending about 22,347 BC with the fire of tectonic plate subduction that is now raising the Himalayan mountains. Mankind as we can see from these figures is a lot younger than we moderns can conceive.

I admittedly even have a problem reconciling occult principles such as the Lemurian sacrifice of Christ (humanoid standing) and the extrusion of the moon from the Pacific ocean, both of which occurred during the Lemurian age with the realistic geologic evidence of planetary evolution. Our traditional methods of radio-active carbon and other isotope dating of fossils and minerals will continue to be sacrosanct until scientists understand that all matter enters a state of radiation, not just uranium and several others. In fact, during the pralaya of the seven vials of wrath, mentioned in the APOCALYPSE, all matter will radiate so that the physical earth will dissolve and heavenly Jerusalem can descend from the astral world.

Looking towards the future, we can extrapolate the dates of the next two cultural epochs as follows:

6. Aquarius	3574 AD to 5734	Russian/Slavic
7. Capricorn	5734 to 7894	American

Thus, ends the Fifth root race in what Dr. Steiner calls the "Great war of all against all."

Now, all of these ages and epochs have their Christian occult symbolism ciphered in the revelations of the APOCALYPSE. In fact, the mysteries of cosmic Christianity can be summarized in the following sentence: The Cosmic Christ administers His Divine Plan thru His angels. The first mystery is that of Christ as the Solar Logos. The second mystery is that of the Divine Plan as reflected in the evolution of the manvantaras, rounds, globes, ages and epochs. The third mystery is that of the ministration of this Plan and the Spiritual Guidance of humanity thru the nine hierarchies of angels, as Christianised by the teachings of Dionysius the Aeropagite, St. Thomas Aquinas and Dr. Steiner.

In each of the 7 letters to the 7 churches, St. John speaks to each successive cultural epoch of this Fifth Root Race. Thus, the first five epochs are addressed: Ephesus as Hindu; Smyrna as Persian; Pergamos as Egyptian/Chaldean; Thyatira as Greek/Roman and Sardis as the European. Reserved for the future sixth and seventh cultural epochs are Philadelphia and Laodicea. As was the history of Lemuria and Atlantis, each great age of the Root Races ends in catastrophe, respectively, the fires and flooding of tectonic plate subduction. Our great Aryan age will end in a huge battle of good against evil, such as seen in the "Star Wars" movie trilogy.

Following the chronology of the Divine plan, there will be two more Root Races following our Aryan root race. The Sixth will commence in year 7894 and adding to this 7 epochs of 2,160 years each (15,120), will end in the year 23,014. This sixth age is symbolized by St. John as the book sealed with 7 seals, each seal being a sub-race cultural epoch of the sixth root race. This evolution will be a resurrection of the Atlanten root race but at a higher level. The Seventh will commence in year 23,014 and adding to this seven cultural epochs of 2,160 years each (15,120), will end in the year 38,134. This Seventh age is symbolized by St. John as the sounding of the 7 trumpets, each trumpet being a sub-race, which also will be a resurrection of the Lemurian root race.

After these great ages, the book of the APOCALYPSE ends with the series of the 7 vials of wrath, the Last Judgment and the New Jerusalem. In every sense of these Christian words, the end of the seventh root race, at the sounding of the seventh trumpet, is the end of our planet earth. Having completed a globe of 7 X 7 Conditions of Form, there will be a short pralaya described by St. John as the pouring of the 7 Vials of Wrath, which is described with thunders, lightnings, earthquakes and fallen nations. This is the radiation of all matter (described above), when the mineral world dissolves. During this transition stage all mankind will be separated into two camps, those of the white robes in whom the Christ impulse resides and those who appear in the form of the beast with seven heads and ten horns, in whom the serpent still resides. During the Last Judgment, an angel comes down from heaven and chains the great serpent and casts him into the abyss of the bottomless pit, together, of course, with his legion of human serpents.

The descent of the Heavenly Jerusalem represents the completed goal of physical evolution of this manvantara. The sixth epoch of the seven seals is the descended astral world and the seventh epoch of the seven trumpets is the descended Heavenly (lower Devachan) world. Of course, we should remember that both the astral and Devachanic worlds consist of what we as humans put into them (ye reap, what you sow). Everything physical will radiate and dissolve and pass over into an astral cosmic globe. After a long pralaya, the Fifth manvantara of the future Jupiter planetary evolution begins with our white robed followers of Christ in seed form.

The abyss is a symbol for the sub-earthly astral state located in nine divisions within the earth's interior (Dante's Inferno). This is opposite to the above earth astral state that extends from the earth sphere to the sphere of the sun. The lower astral world consists of evil elementary Ahrimanic spirits and also human souls that have not evolved past the animal form of the beast. As slaves to their passions, desires and instincts, they have separated out from those humans who have purified their astral bodies and also bear the Christ impulse within. To the above earth astral world will ascend the successful souls waiting in the Heavenly Jerusalem for their incarnation into the next Jupiter manvantara. To the sub-earth astral world and possibly the Eight Sphere will descend those failed evil souls where they will wait as elementary spirits, the Final Judgment at the end of the Vulcan manvantara and the final separation of good and evil.

It was not our purpose here to discuss all the symbols of the APOCALYPSE, but to only provide a skeleton form in which to display the chronology of the ages and epochs of mankind which serves as a foundation for these meditations.

6. 7,894 to 23,014	Sixth root race	7 epochs of 7 seals
7. 23,014 to 38,134	Seventh root race	7 epochs of 7 trumpets

The end of time; Short Pralaya - age of the 7 vials of Wrath;

The Last Judgment;

The descent of the Heavenly Jerusalem;

Long Pralaya;

Beginning of the Jupiter manvantara.

THE SATURN CYCLE

There is another confirmation of the lengths of the ages and epochs of mankind as outlined above. Robert Powell in his new book *THE CHRONICLE OF THE LIVING CHRIST* (1996) discloses his discovery of the "Saturn Period." As is common knowledge, the orbit of the planet Saturn around the sun is approximately 29 1/2 years. Now, if one orbit is compared to one day in the ministry of Christ, a secret cycle unfolds. According to his calculations, taken from the visions of Sister Anne Catherine Emmerich (hereinafter, Sister Christian), the ministry lasted exactly 1,290 days, beginning with the baptism in the Jordan on September 23, 29 AD to the Resurrection on April 5, 33 AD. This 1,290 days is also a secret cycle mentioned in the book of Daniel and translated into 3 1/2 years, is also mentioned several times in the *APOCALYPSE*.

Powell calls the ministry of Christ His "embryonic period" because the Baptism by St. John actually marked the beginning of the life of Jesus as bearer of the spiritual being of the Christ as Solar Logos. Prior to the Baptism, the Nathan Jesus was human in every sense of the word, granted, the greatest human who ever lived, but still human. This raises an old debate about the divine nature of the Jesus person. We know that the ancient teaching of the Nestorians preserved a deep secret of Esoteric Christianity, that the incarnation of the Christ being as solar logos occurred during the Baptism when the Father said "This is my beloved Son, today I have begotten Him." Nestorius (b.381 AD) was an Aristotelian Christian who provoked the great ecumenical debate against the monophysites. Following Cyril of Alexandria and the Platonic Christians, they believed in the unification of the two natures, man and God, of Jesus into an undifferentiated Divine form. Part and parcel with this belief, was that Mary, the mother of Jesus, was also likened to a god, for giving birth to a God.

Nestorius, being learned in the great Aristotelian tradition written down in *DE ANIMA*, knew that the spirit (nous) descended into the body (soma) and is a nature completely separate from the body. The (Holy) spirit would enter (thyrathen) the body from the outside, both for Mary at the Annunciation and for Jesus at the Baptism. This Duophysite (two natures) doctrine of Nestorius, was declared heretic at the 3rd Ecumenical Council of Ephesus in 431 AD. This act of the church fathers, of course, laid the mind set for the later 8th Ecumenical Council held in 869 AD in Constantine wherein the trichotomy of body-soul-spirit was also declared heretic. We will see the Nestorian doctrine resurrected as the "Active intelligence-Holy Spirit of the moon sphere" in the 11th century metaphysics of Avicenna and Averroes, which was later debated by another Aristotelian, St. Thomas Aquinas.

Following the Nestorian esoterism, we will start the Embryonic period of the life of Christ at the Baptism. Whereas the life of a single person unfolds in successive 7 year intervals, so that of the Christ unfolds historically over the entire life of humanity. Each day of His ministry is imprinted into the cosmic heavens of our solar system, which extends to the planetary limits of Saturn. The Greek name for Saturn was Chronos, the ruler of time. Indeed, Dr. Steiner says that Saturn is the "guardian of cosmic memory" who records all that occurs in planetary life.

If we correspond one day in the ministry of Christ with one orbit of Saturn, we find a secret cycle of (1290 days X 29.4578 years) 38,000 years. Adding to this the 33 years in the entire life of Christ, the result is within one hundred years of our year 38,134 AD which we calculated above as the end of historical time for humanity as ciphered in the *APOCALYPSE* (the end of the Age of the 7 trumpets).

Thus, we have first, the Saturn Period as a confirmation of historical time as described in the *APOCALYPSE*.

Second, we can conclude with Powell that the ministry of Christ "contains in seed-form the future evolution of the Christ impulse as it unfolds through historical evolution."

This conclusion can be reached about no other religious teacher, avatar, manu, buddha or messiah. With Christ being the fulcrum of historical evolution, *THE LIFE OF CHRIST EQUALS THE LIFE OF HUMANITY*. His life serves as an archetype of the future evolution of humanity. Thus, the great events in His life, such as the Baptism, the Temptation, the healings and miracles, the Transfiguration, the entrance into Jerusalem, the Last Supper, the Passion, the night in Gethsemane, the Crucifixion, the Deposition and Resurrection, all these events in His life will have their corresponding reflection on the physical plane during the entire life of humanity over the next 36,000 years. We are presently still in the age of the Temptation in the Desert which lasted for Christ, 40 days and will last for humanity (40 X 29.5 years) 1,180 years.

Do the time equations for yourselves, follow the development of the macrocosmic ego of the Christ over the corresponding microcosmic evolution of humanity. Here is wisdom.

3. THE SEPTENARY IN RELIGION

A. The Lemniscate of Religion

Leminscate of Religion

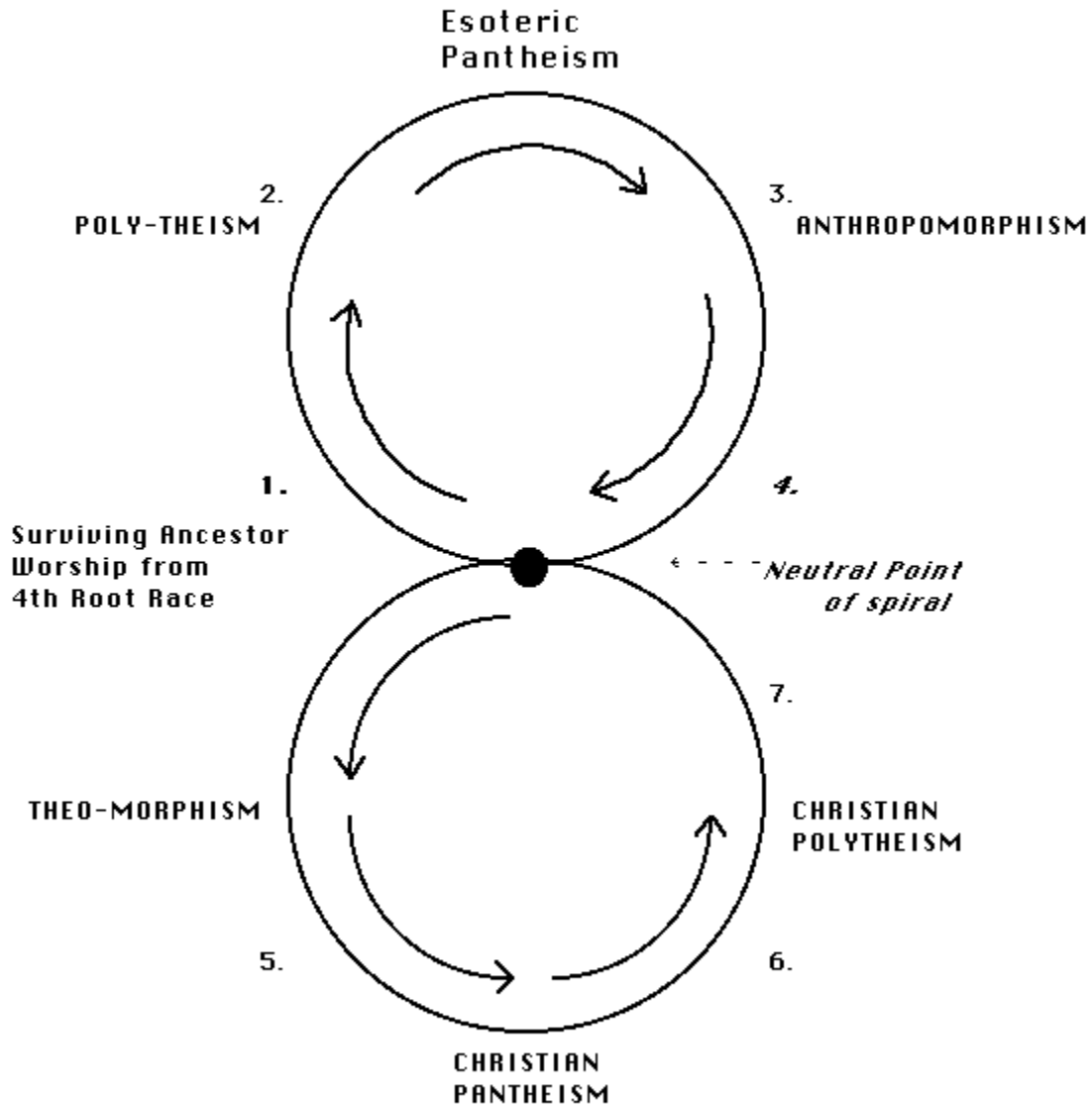

Harrison's Evolution of the God Idea through 7 forms in the Fifth Root-Race

The traditional correspondence between the so-called religious ages of man has an astronomical basis in the Great Solar Year of 25,920 years divided by the twelve zodiac signs into cultural-religious epochs of approximately 2,160 years as follows:

- Sign Sub-Race/Cultural Epoch
1. Cancer Hindu-Indian
 2. Gemini Persian
 3. Taurus Egyptian-Chaldean
 4. Aries Roman-Greek

5. Pisces Fifth (Present)

6. Aquarius Sixth

7. Capricorn Seventh

The leading mission of the Fifth (Aryan) Root Race is the development of manas, the thinking faculty, on the physical plane. The origin of logical and analytical thinking began in the fifth sub-race of the Fourth Root-Race in the peoples designated by Theosophy as the Primal Semites. The elect of this group were the last to migrate from the sinking Atlantis. Following the great Manu, they traveled from Ireland, eastward through Europe to Central Asia. From here, a colony was directed out to the Indus valley to start the First Cultural Epoch known as the Hindu-Indian civilization.

Manu directed the seven Rishis to guide the new Fifth root-race and to direct its evolution towards the development of the mental faculty of thought. In addition, Manu directed that all human activities, all human institutions, all cultural achievements in science and art bear a religious character reflecting man's aspiration to higher, spiritual worlds. Thus, the fifth root-race carries with it a profound religious fervor different from the mission of the fourth root race.

Against the direction of the Divine Plan of the Spirits of Form and the seven Rishis, the sixth sub-race (the Akkadians) and the seventh sub-race (the Mongols) held over after the end of the Atlantean period. The oriental Mongols have become the most populated sub-race in the world today. They too partially developed the thinking faculty. However, for various reasons, they held firm to the ancestral memory of their culture and neglected the intended development of the thinking faculty. The development of the thinking function of the ego is inversely proportional to the memory function held in the etheric body.

The chief characteristic of the fourth root-race was an unlimited ancestral memory, which was firmly held over in the Mongol sub-race. Traces of this can also be seen in the Malay sub-race and Polynesians who keep the skulls of their ancestors hung from the door of their houses. From ancestral memory developed ancestor worship which held the same position in the Atlantean races as religion does now in the Aryan races. The transition from the fourth to the fifth root-race was marked by the decline in ancestor worship and the rise of Polytheism.

In 1893 a certain A.G. Harrison gave a series of lectures to a group of esoteric Christians naming themselves the Bearean Society. As a group of "theoretical occultists", their task was to evaluate the growing influence of the good Madame H.P. Blavatsky in relation to traditional Christianity with a strong dose of Catholicism. These lectures have recently been reprinted in a 1993 edition entitled, "THE TRANSCENDENTAL UNIVERSE".

Harrison, as a self-initiated occult Christian recognized the septenary in the Religions of Man. In a most unique configuration, he relates the intellectual growth of the Theology of the fifth Root Race to the successive growths of the seven sub-races and/or the cultural/religious epochs.

Harrison is careful to explain that the seven sub-races do not exactly correspond to the seven forms of the evolution of the God Idea in the fifth root race. His configuration is as follows:

Polytheism
Esoteric Pantheism
Anthropomorphism
Theomorphism
Christian Pantheism
Christian Polytheism

Polytheism is the worship of many gods, a pantheon of deities. Harrison says this religion is characteristic of the Hindu Brahmans. Indeed, the good Madam H.P.B. has often remarked that this culture has names for no less than 330 million spirits.

Pantheism is a view of the entire created universe as a manifestation of God, not God as a deity, but as the sum total of the forces acting in the universe. Schopenhauer was the modern representative of this religion of the uneducated masses. Harrison says that, "While Brahminism is a polytheistic religion for the multitude, it is founded on a philosophical system which is essentially Pantheistic". Thus, for him the esoteric doctrines of the initiated and adapts of Hindu Brahminism represents the second stage.

Anthropomorphism, which includes the monotheism of the Jews, represents an advance for Harrison, because Hindu Pantheism was purely an intellectual doctrine, devoid of any personal or moral aspects. For the first time in the fifth root-race, the high spirituality and detached intellect of esoteric Brahminism was put in a new direction by the Jews, that of a god in separately connected with the idea of righteousness. The anthropomorphic act of giving god a personality, such as the avenging Jehovah, necessarily gives a moral character to god and his worshippers. Likewise, the name given to god by the Jews is a personal one, distinguishing the true god from all false ones. In Christian theology, the god made man and the word made flesh is the ultimate act of anthropomorphism.

Harrison arranged his six stages of the intellectual understanding of the God-Idea around a neutral center in the shape of a lemniscate. Technically, a lemniscate is in geometry the locus of the foot of the perpendicular from the center of a conic on its tangent. In two dimensions, a figure eight is representative and in three dimensions, a double cone or vortex is representative. Realizing that belief in God can take only three forms, i.e., polytheism, pantheism and anthropomorphism, the last three stages for the Harrison lemniscate are a repetition of the first three, only at a higher stage and in the opposite direction.

This is a very sound principle in fact for the lemniscate is an ancient esoteric symbol. First described by Plato in THE TIMAEUS, with later commentaries by Macrobius and the Stoics, this symbol becomes the gyres of St. Thomas Aquinas and the divination tables of Dr. Dee. Swedenborg said, "all physical reality, the universe as a whole, every solar system, every atom, is a double cone; where there are two poles one opposite to the other, these two poles have the form of cones". In the 20th. century, W.B. Yeats wrote (by automatic writing from the spirit of Giraldus) an entire history of Western civilization using the double cone divided into twenty-eight lunar phases as a symbolic template. In the near future, the lemniscate will become a fundamental theorem of science. One only need look at the Lorentz attractor (another view), a figure-eight in a finite space with an infinite orbital path that never repeats itself nor crosses itself.

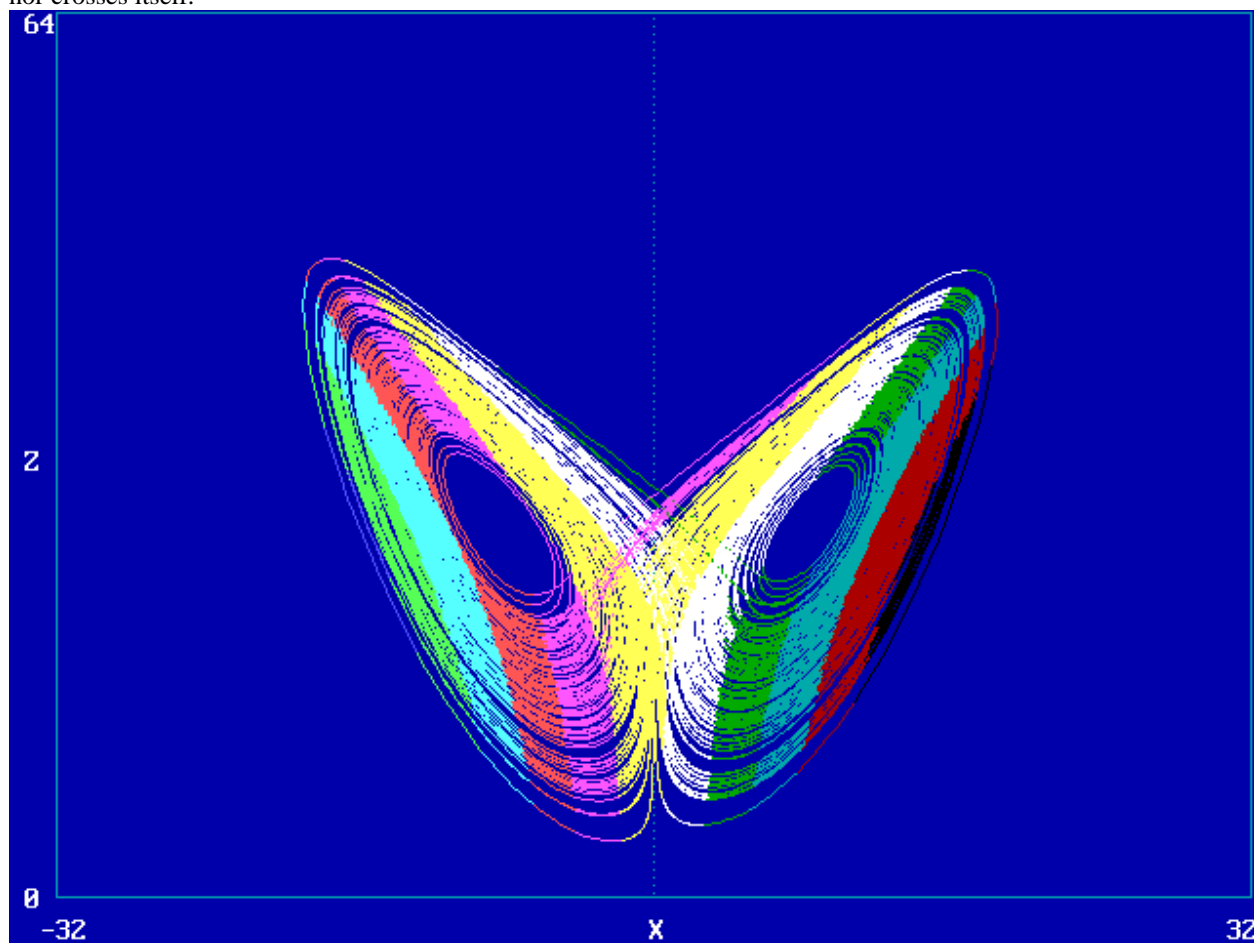

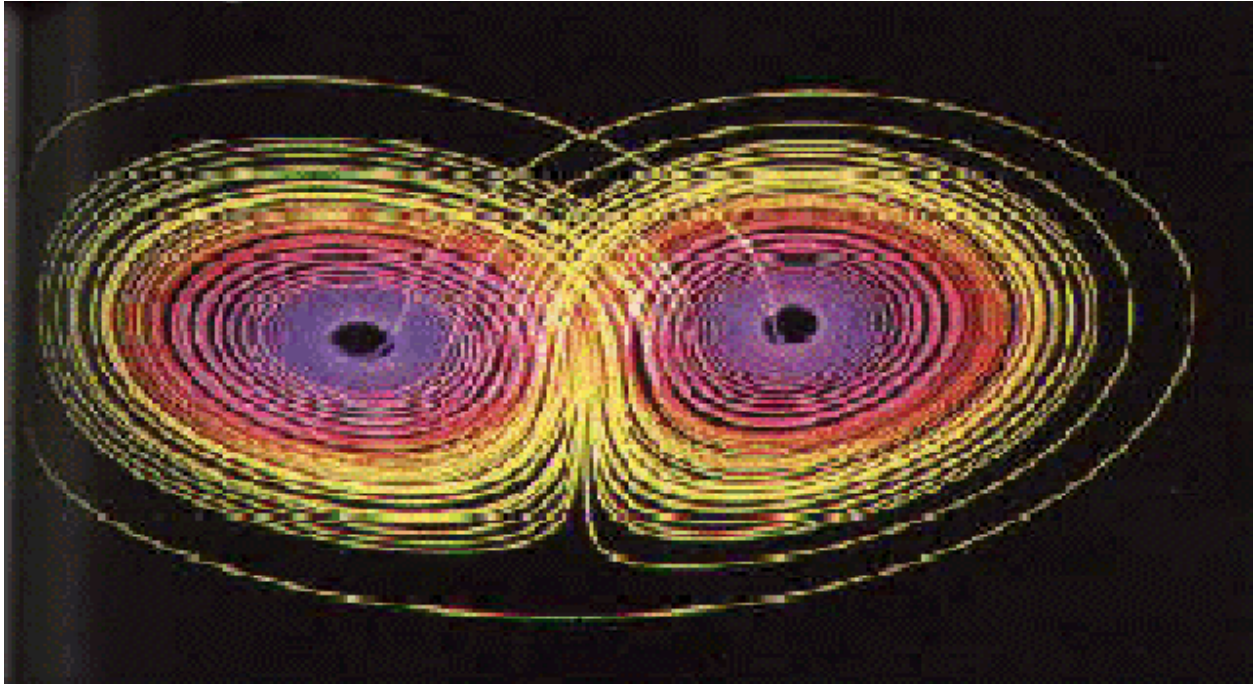

"The evolution of the God-Idea starts at this neutral center, arrives at the same point halfway in its evolutionary course; and touches it again at its finish". For Harrison the neutral center is ignorance, which in modern times, corresponds to Agnosticism.

At the close of the fourth sub-race, Harrison describes what he calls Theomorphism or the worship of the Divine Man. The ages of faith of medieval times, the doctrine of the Holy Trinity and the Latin Catholicism of the Western Europe characterizes this period.

Harrison next proceeds to the fifth sub-race which he sees as roughly the English speaking people which have replaced Latin Christianity. In its modern guise, Theomorphism is characterized by the scientific materialism of modern Europe and America. Finally he says, "The religions and intellectual evolution of the sub-race are both converging to the point of sacramentalism, and when this point is reached, and the pioneer of scientific sacramentalism appears, the fifth period of the evolution of the God-Idea will draw towards its close, and Christian Pantheism will put an end to the conflict between science and religion which has lasted so many centuries."

Harrison explains "sacramentalism is to the spirit what symbolism is to the mind and both are systems which make use of the visible and material things to convey benefits of an invisible and immaterial character..God, as revealed through Christ, conveys his grace, or life giving spiritual impulse, through the medium of the sacraments." The seven sacraments, Baptism, Confirmation, Eucharist, Matrimony, Penance, Order and Extreme Unction are the evolutionary equivalents of the seven-fold involutory spiritual energy which cause birth, strength, nutrition, generation, recuperation, speech and transmutation.

Sacramentalism can not be practiced without a profound respect for ceremonial order, which probably corresponds to what Alice Bailey describes as the seventh ray now coming into manifestation for the Fifth Root Race. The seventh ray is one of ceremonial order and control over the forces of nature. Magic, ritual and sacramentalism are characteristic of this ray which she says will manifest itself predominantly through the Russian nation.

Christian Pantheism of the Fifth (English) sub-race had its beginning in the works of Anna Bonus Kingsford (1846-1888). She was quite a leading lady of 19th. century western Europe. In 1870 she became a Roman Catholic, later separated from her minister husband and throughout her life was an editor of numerous women's rights magazines. Between 1874 and 1880, she lived in Paris with her spiritual mentor, Edward Maitland, as uncle and niece, to attend and finally graduate from medical school (where she was refused in England). During this time, her and Maitland experimented together in spiritual researches as mediums. They were contacted by elementary spirits, ancient Egyptian and Greek spirits, by individual spirits such as that of Apollonius of Tyana and Swedenborg and even had visions of scenes from the life of Christ. These very occult "illuminations" produced a coherent dogma of Esoteric Christianity which they sponsored as a "new Gospel". During May and June of 1881, Maitland and Kingsford presented this material in a series of lectures in London to private audiences. The lectures were published a year later as THE PERFECT WAY or the FINDING OF CHRIST.

In 1883 Kingsford was elected president of the London Lodge of the Theosophical Society and obviously she must have had a close working relationship with the good Madame H.P.B. Even though she was more connected to Gnostic Christianity and Egyptian Hermetic sciences, the Mahatma letters state that her appointment was approved by the master Koot Hoomi. A fierce battle arose over her appointment with A.P. Sinnett who had returned to London in April 1883 after losing his newspaper editorship in India. Nowhere was the schism between Western Christian occultism as represented by Kingsford and Maitland and Eastern Indian occultism as represented by Blavatsky and Sinnett more evident than the split in the London Lodge. To solve the problem, Olcott offered Kingsford her own separate charter called, "the Hermetic Lodge of the Theosophical Society." which she accepted while Sinnett got his candidate elected as new president of the London Lodge of the T.S. Renamed the "Hermetic Society", Kingsford and Maitland enjoyed a huge success giving lectures and publishing books on Egyptian Hermeticism.

As her Esoteric Christianity (based upon Egyptian Hermeticism) evolved, she became learned in the additional occult sciences of Alchemy, the Hebrew scriptures, the Hebrew Kabbalah, Gnostic Christianity, Orphism, Angelology and in 1887, thru the manuscripts Eliphas Levi, the occult astrology of Trithemius and the coming age of Michael. Had she not died an early death, she might have accomplished a synthesis of the entire Western tradition of occultism and her special brand of the new Christian revelation. Her Christian esotericism had its unique influence on Annie Besant, C.W. Leadbeater, G.R.S. Mead, A.E. Waite, C.C. Massey and her financial sponsor, the Lady Caitness.

The Perfect Way is the most often quoted source book in the Secret Doctrine. In fact, it reads like a treatise on Esoteric Buddhism, with the Bible replacing the Stanzas of Dzyan and Christ representing the perfect Buddha. She accepts the traditional Eastern concepts of incarnation and karma and places them in a Christian context. As for the Trinity, the Father is deity unmanifest and the Son is deity manifest. God unmanifest and abstract is the primordial mind and the cosmic universe is the ideation of that mind. To think is to create. Each planet and orb in infinite space is a thinking, creative god. Likewise, the individual human ego and soul is the "agglomerate essences" (or synthesis) of the numberless consciousness composing us.

Of greatest interest, her organic Pantheism evolves from synthesis into the discovery of that greatest achievement of R. Buckminster Fuller, the idea of Synergy. First, on the chemical level, she recognizes the principle that water is greater than its parts of hydrogen and oxygen saying, "The sum of activities of the molecules of the resulting product is different from that previously possessed by its factors..The synthetical resultant is not a mere aggregate of constituents." Then, on the religious level, she corresponds the synergy principle to the human soul and then to the macrocosm, as follows:

"Such as all creatures composing the planet are to the planet, all the planets are to the universe, and such are the Gods to God (in manifestation). The supreme Ego of the universe is the sum total of all the Gods; His Personality is their agglomerate personalty; to pray to Him is to address all the celestial host, and, by inclusion, the souls of all just men. But as in man, the central unity of consciousness constituted of the association of all the consciousness of his system, is more than the sum total of these, inasmuch as it is on a higher level;-so in the planet and the universe. The soul of the planet is more than the associated essences of the souls composing it. The consciousness of the system is more than that of the associated consciousness. The consciousness of the manifest universe is more than that of the corporate systems; and that of the Unmanifest Deity is greater than that of them all. For the Manifest does not exhaust the Unmanifest; but the Father is greater than the Son."

Buckminster Fuller aside, Kingsford is the first to discover and name (synthetic resultant) the principle that the whole is greater than the sum of its parts. For her, the organizing synergy is mind and god. For Fuller it is geometry, but what is the difference if as Plato said, God geometrizes.

She also accepts in her new Gospel, the traditional Catholic doctrines of the Immaculate Conception, the Assumption of the Blessed Virgin, the Fall, Original sin and the doctrines of the Redemption and Atonement. Her discussion of angels, elementary spirits and the astral plane was the best to be seen until the arrival of R. Steiner, several decades later. She also divides the human person into four principles, which include the septenary principles of the T.S. and the Good Madame as follows:

1. material body (includes sthula-sarira and prana)
2. astral body (linga-sarira, kama-rupa and manas)
3. soul (buddhi)
4. divine spirit (atma)

For her, the soul incarnates in many different bodies to evolve to union with the divine spirit, the Christ within. At this time, even the T.S. did not teach about reincarnation, as ISIS UNVEILED side-stepped the issue. Only with the publication of Sinnett's ESOTERIC BUDDHISM in 1883 and in several articles in THE THEOSOPHIST magazine, did the T.S. learn that the Tibetan Mahatmas endorsed reincarnation. It must have caused quite a stir in the T.S.

when the Catholic Kingsford was actively teaching the theory that the good Madame, then living in India, rejected in ISIS.

If anything bothers me about this great Christian spiritualist, it would have to be the comment of Henry Olcott when he met her in 1884 that, "there was something uncanny to me in her views about human affection. She said she had never felt love for a human being...yet she lavished excessive love on (her pet) guinea pig." For someone to have actual visions of Christ and not feel human love is certainly a waste.

Christian Pantheism at this early stage of development must have borrowed all of its esoteric concepts from the Esoteric Pantheism she intuitively absorbed from Egyptian Hermeticism and Orphism, and grafted into them, the Christ impulse. She writes, "the fundamental truth embodied is the doctrine of Pantheism; God is in all things, God and God only, in all and through all." I suppose this is only natural if one looks at Christian Pantheism as a repetition of Esoteric Pantheism, only at a higher stage, the higher stage being the additional mystery of the Christ event. The common ground of Pantheism probably is what earned her the respect and support of the good Madame and the Master Koot Hoomi. However, at the present time, the Eastern religions of Esoteric Buddhist and Bramin Pantheism do not recognize Christ as other than one in a succession of Avataras. The prejudices against Christ in the Hindu, Brahman and Buddhist religions is also only natural historically, since these religions pre-date the Christ event by many thousands of years.

However, the prejudices of the leaders of the Theosophical Society are more difficult to accept. For example, the rift caused by A. P. Sinnett to oust Kingsford from the London T.S., her tenure as a Christian president lasting only one year. Although the Theosophical movement represents itself as a generic pantheism with all religions sharing an equal footing, this theological concession is only made if one also accepts the Mahayana Buddhism theosophy of the good Madame as the mother source of all religions.

The good Madame's hatred of the Western Christian churches and all practicing Christians was most pervasive. Her successor, Annie Besant, fired R. Steiner as head of the German Section of the T. S. while on his way to Genoa to give a lecture series on the relationship of Buddha with Christ. It was unbearable to her to have a T.S. member extol Christ and not Buddha as the center-point of earthly evolution. Another successor of the T. S. in America, G. de Purucker, calls Christ the "Syrian Initiate" and teaches that Christ is an Avatara incarnation of the nirmanakaya of Buddha.

The fact is that Christian Pantheism will never become a religious force in the Lemniscate of sub-root races as envisioned by Harrison, unless and until it divorces itself from the Theosophical movement. Harrison clearly recognized this unhappy marriage between his London contemporaries, Kingsford, Blavatsky, and Sinnett and in his lecture series, taught that Blavatsky was duped by Hindu occultists and that the Masters K.H. and M. never existed. In addition, Harrison fervently opposed the Eastern principles of re-incarnation and karma feeling that these doctrines were premature and harmful to traditional European Esoteric Christianity.

On the last turn of the lemniscate, Harrison describes Christian Polytheism as the nine orders of celestial creative beings described by Dionysius the Areopagite. We will deal with the angelic orders later, but the important point is that Harrison recognizes the Divine hierarchies of Dionysius as the final and highest form in the evolution of the God-Idea for the fifth root- race.

B. SEVEN CULTURAL EPOCHS

A vastly difference approach to the septenary in the religions of man is taken by Steiner in his lecture series entitled, *Egyptian Myths and Mysteries*, (1908). For him, the religions of man reflect the cosmic events of planetary evolution.

Using Rosicrucian terminology, the evolution of our solar system develops through seven successive planetary conditions (also called Manvantaras). The first was called Old Saturn which was a condition of a nebula, the perimeter of which extended to the orbital limit of the planet Saturn. No planetary bodies separated out at this stage characterized by uniformity. During the next manvantara called Old Sun, a central cosmic sun separated out at this stage characterized by duality. During the third manvantara called Old Moon, a central sun again separated out of the nebula and for the first time a planetary condition arose. A planet called the Old Moon orbited the sun in the same way the present moon circles our present earth, ie. with only one side facing the sun. This created a condition of intense heat and light on one side and intense cold and darkness on the other side. This condition was three-fold. During the pralaya after the Old Moon evolution, the planets fell back and united with the sun.

Only in the fourth round of the fourth manvantara did the present earth condition arise. During the first three rounds, there was a recapitulation of Old Saturn, Old Sun and Old Moon. Then, during the first three root-races of this fourth round, there was another recapitulation of these previous cosmic events. During the first root race, that called the Polarian, the sun, earth and moon were united in an arupa-sphere. Here were laid the seeds for the human species known as the "sons of the sun". During the second or Hyperborean root race, the earth separated out as an orbiting planet. At this time, the Solar Pitris incarnated in man creating an upright posture, the beautiful Apollo-men. During

the third or Lemurian root-race, the moon extruded out of the earth and bi-sexual evolution commenced. During this time, the Lunar Pitris incarnated creating our physical ancestors. Thus, what occurred in spiritual cosmic events of planetary evolution in three stages is reflected in the physical world as:

1. Unity - Sun
2. Duality - Sun and Earth
3. Trinity - Sun, Earth and Moon

As Harrison recognized supra, religion did not come into its own until the Fifth or Aryan root race. The previous Atlantean epoch was characterized by ancestor worship deriving from an unlimited ancestral memory extant in the etheric bodies of the races.

For Steiner, the cosmic events of planetary evolution are reflected in the epochs and religions of man. This is a very profound correspondence which he describes,

We have unity in the primeval past as the attitude of the Indian; while the duality that appeared with the separation of the sun is reflected in the religion of the Persians; and in the religions view of the Egyptians, Chaldeans and Babylonians we find the trinity that appeared in the third epoch, after the separation of the earth and moon. Trinity appears in all the religions of the third period.

The Brahman-Hindu religion of the Indians really does contain all in unity. First, there is the oneness of the monotheistic para-Brahman. Then there is the trimurti of Brahma, Vishnu and Shiva. The ancient Brahmins were fire worshipers and performed sacrificial rites, the lower castes were idol worshipers of the lingam and yoni. The four Vedas contain the ancient wisdom of the world as given by the seven Rishis. The later Upanishads originate the grand doctrines of incarnation, karma and nirvana. Cult worship appears in the doctrine of the Avatar, or ten incarnations of Vishnu. Sect differentiation arises with initiation rites, mantras and gurus. The Hindu angelic pantheon is almost infinite. Hinduism is the great ocean of all religions.

The second cultural epoch is characterized by the duality of Zoroastrianism. The doctrine of Zarathustra is preserved in the seventeen hymns of the Gathas and the holy scripture of the Avesta. For him and the later Zurvanites, there are two fundamentally opposed principals which always are in conflict, light and darkness, good and evil, the sun aura of Ahura Mazda and the earth-moon forces of Ahriman. This duality is so pervasive that while every other religion recognizes the twelve creative hierarchies of the twelvefold zodiac, the mind of the Zoroastrian recognizes only six, the Bounteous Immortals or Amahraspands. For them, even the zodiac is not a unity of twelve but six plus six, good and evil, ascending and descending.

The third cultural epoch is characterized by the trinity of earth - sun - moon. In Egypt, we see Osiris, Isis and Horus. For the Chaldeans, it was composed of Anu, Bel and Hua. Even the Jews, which to this day deny the trinity and had their beginning (Abraham from Ur) and their captivity in Chaldea, when it came time to appoint vowels to pronounce their sacred name JHVH, added the vowels from the Chaldean trinity. J e h o v a h is Bel, Hoa, and Anu.(see the table of correspondances for the Trinity on page).

For the early Christian Gnostics and Ophites, the supreme God was IAO, from whom derived the seven planetary aeons or genii. Pronounced ee - ah - oh, in the first instance, the letters e - a -o came from the same Chaldean trinity and in the second instance, correspond to I = Isis - Virgo, Nature, Mother

O = Osiris - Sol, slain and risen

A = Apophis - Scorpio (Typhon, Set), death & destroyer

As the good Madam H.P.B. exposed in ISIS UNVEILED, the doctrine of the trinity is eminently pre-Christian and representative of all cultures of the third sub-race or cultural epoch.

In the fourth sub-race we see a new impulse derived through the Jewish peoples, that of monotheism. This religion represents a turning away from the direction of the first three sub-races, which were characterized by a differentiation from the original Hindu unity. Thus, there are now two religions currents manifesting in evolution. The first is that of plurality or emanation from unity. This current proceeds from a number which in the first instance is the one, the para-Brahman. Then, the three represented in the trinity; the seven, represented in the planetary aeons, genii, Elohim and St. John's seven Spirits before the Throne. Finally, there is the twelve, representing the creative hierarchy forces of the twelvefold zodiac fixed star system.

The second current is that of monism, a synthetic, all pervading movement towards the monad, represented by Jewish monotheism and the Books of the Quabbalah. The polarity created by these two currents are necessary for the proper development and evolution of the religions of man. An associative force towards unity and a dis-associative force away from unity, into plurality. Both forces corresponding to the fundamental polar forces of the physical plane, centrifugal and centripetal.

Beginning the fifth sub-race, Steiner recognized the lemniscate or double vortex of religion and the principal of repetition working again on a higher level. For him, the fifth, sixth and seventh sub-races repeat themselves at a higher level as a repetition of the third, second and first sub-races. Thus,

1. Cancer	Hindu/Indian	Unity
2. Gemini	Persian	Duality
3. Taurus	Egyptian/Chaldean	Trinity
4. Aries	Greek/roman	Monotheism
5. Pisces	fifth	Trinity
6. Aquarius	sixth	Duality
7. Capricorn	seventh	Unity

In our fifth cultural epoch, there has been no decline in the belief of the Trinity. However, the chief characteristic of this period, as also observed by Harrison, is scientific materialism. Steiner says that this attitude comes from the spiritual fact of the Egyptian practice of mummifying the dead. By preserving the outer form of the body, the soul after death was more bound to the physical plane. The soul is susceptible to impressions after death and the picture of the mummified body made a lasting impression on Egyptian souls after death. These same souls have now incarnated in this fifth epoch and this remembrance lives on as a strong impulse to materialism.

In Foundations of Esotericism, Steiner says that the entire fifth root- race is descended from the primal Semites, who were the fifth sub-race of the Atlantean (fourth) root- race. Likewise, a new spiral is forming in the fifth sub-race of this fifth root -race, that of the hidden spirituality of the Russian peasantry. As the culture of the present fifth cultural epoch is descending, the culture of the Russian sixth cultural epoch is ascending. The first three cultural epochs had a common esoteric mystery center source. The fourth epoch of Semite monotheism is neutral, as observed by Harrison, and repeats none of the former or later epochs. Beginning the fifth epoch, a new impulse emerges in the Russian people, looking towards the future, while repeating the former first three epochs on a higher level. The central and western European cultures are the advance post of what is to develop out of the Slavonic peoples of the European east. For Steiner, the future sub-races or cultural epochs are:

5. Pisces - Central European, led by German
6. Aquarius - Eastern European, lead by Slavonic
7. Capricorn - American

The task of the German peoples of this fifth cultural epoch is to take in the Christ impulse more and more consciously in the future. This Christ impulse has worked sub-consciously in the astral and etheric bodies over the past centuries. Now and in the future, the "marriage in heaven" of Martinus Cappella and Christian Rosenkreutz will take place ever more often, this being the conscious union of the ego and astral body with the Christ impulse. This task of the German peoples is being accomplished by their guiding folk spirit in a unique way. Historically, souls in incarnation pass from one culture to another. It is unusual for a person having lived, for example, as a Greek, to be incarnated later in the same Greek culture. However, in present Germany are souls who have lived as members of the Germanic tribes in the past. This gives a particular strength to the Germanic folk spirit and a conscious link with the Christian religion. When in their next incarnation, these former German souls appear in the Slavonic culture, there will be a rapid cultural evolution characterized by this united Christ impulse. That which will happen in the sixth cultural epoch will be prepared beforehand for the Germanic peoples.

The civilization of the Slavonic peoples in the future sixth cultural epoch will be primarily a receptive one working on two levels. First, there will be the receptivity of the achievements of Western Europe, such as the technology, music, arts and sciences. The field of experimentation of modern technology lies in the West and the fruits of its success shall easily pass to the sixth culture.

Second, there will be the receptivity of the descent of the spiritual forces of the sixth principle, Buddhi. The full manifestation of Buddhi on the physical plane will occur in the next Round during the future sixth root- race, while the sixth sub-race in this fourth Round will receive only a taste of what the future holds. This taste, where the ego looks upwards to the higher principal, will manifest itself as a duality in mankind corresponding to the duality felt by mankind in the second, Persian, cultural epoch.

As stated supra, the bodies of man consists of the lower quaternary of physical, etheric, astral and ego. Above this quaternary, stand the trinity of macrocosmic principles, Manas, Buddhi and Atma. The first three principles of the lower quaternary have fully descended upon mankind and have been incorporated into his being, the fourth is presently in manifestation. The trinity of the higher principles have only partially descended upon mankind and only in a few adapts have they been incorporated into their being.

For the mankind of the fifth cultural epoch, there is not yet any duality between the lower quaternary and the higher trinity because the ego is still firmly grounded in the lower quaternary. However, as the ego matures into the sixth cultural epoch, for many persons the ego will ground itself in the higher trinity. In this respect, the Hindu

classification of the septenary in man is more descriptive than our Western model, because it recognizes a higher and lower manas.

Using this Hindu terminology, the ego of the man of our fifth epoch has its center of gravity in lower manas, while the ego of man of the sixth epoch will have its center of gravity in the higher manas. This will create a duality in which man will consciously feel the higher manas struggling to hold the lower manas in complete control. Two WILL CENTERS develop in man, each the expression of the ego manifesting itself in the higher and lower natures. In the terminology of C.G. Harrison, each will center can be considered double vortices acting against each other at unequal velocity or force, producing our old friend, the lemniscate. These conical spheroids, which projected in two dimensions as double spirals or vortices, revolve in opposite directions until equilibrium is reached by an axial coincidence of the rotational planes. This equilibrium is the "marriage in heaven" of the higher and lower manas. Steiner says that this duality felt in each individual man will express itself in theology as an experience of the duality inherent in Christ. His divine nature is represented microcosmically in the higher trinity and his human nature so represented in the lower quaternary. Understanding the Christ being as an organic unity of divine and human natures will help man to understand and balance his higher and lower manas. Christianity in the future will come to shape the social order of our towns, states and nation.

ASIAN WAR

It should be considered also that the Asian continent bears three totally different sub-races. The Chinese culture derives from the last of the seven sub-races of the fourth Atlantean Root-Race. This is a wholly self-contained culture not capable of further development, since they did not take up the ego impulse of the primal Semite sub-race. The Hindu-Indian culture derives from the first sub-race of the Fifth Aryan root-race and represents a polar opposite to the Chinese culture preserving the Atlantean character. Since all sub-races of the fifth root-race receive the ego impulse to a certain extent, the Hindu-Indian culture is capable of further development. However, this development is limited since their folk-spirit evolved its high spirituality prior to the Christ event.

It would seem very likely that these two opposite cultures, the last of the Atlantean race and the first of the Aryan race, would someday come into conflict, even war. And if this conflict did arise, it would occur in the backyard of Russia, the evolving future sixth sub-race.

THE ALPHA-OMEGA CONFLICT

The seventh sub-race or cultural epoch will see a return to unity, characteristic of the Hindu-Indian sub-race but, again, repeated at a higher level. In a certain sense, mankind was destined to so return because when the spirit of the age of the first sub-race of India has completed his task, he was raised to the guiding spirit of the entire evolution of the fifth root-race.

Even though this spirit is evolving over the many thousands of years of this root-race, he necessarily must retain some of his original Hindu character. This Hindu character experienced the ego or I subjectively long before it was able to experience an objective ego or I available after the Christ event. The Hindu culture is the Alpha or first sub-race and was very mature in its soul development and spirituality at the time of the Christ event, which occurred many thousands of years after the Rishis appeared to instruct the old Indians. The Christ event could not be grasped and understood by a culture who did not recognize the workings of the angels and archangels that cooperatively who brought about the Christ event.

At the opposite extreme, we observe in the cultures of the fifth and sixth sub-races, the relatively young peoples of Western and Eastern Europe, who lived through workings of the angels and archangels who brought about the Christ event. For example, the folk-spirits (archangels) of the English (1650), Italian (1530) and French (1600) peoples did not achieve an ego-will-identity, which in the physical plane reflects itself as a distinct nationality, until the 16th and 17th Centuries. Prior to this time, these cultures were barbaric compared to the mature Hindu, then later Persian and still later Egyptian sub-races. For the peoples of Western Europe, the ego was more of an objective reality that developed relations between things, such as other people, other groups and other nations. As the ego matures into the last Omega seventh sub-race, it will harden, become selfish and evil.

The task of this presiding spirit of the fifth root-race is to unite the Alpha races of the subjective ego with the Omega races of the objective ego. The religions of the Alpha cultures look backwards to a union with the spiritual worlds with a personal subjective ego. Thus, Hinduism, Brahmanism and Buddhism are characterized by suppression of the ego, a denial of the senses, a recognition of maya, an escape from desire and rebirth, and a personal striving to nirvana.

The religions of the Omega cultures look forward to a union with the spiritual worlds with an impersonal, objective ego. The Omega religions carry within themselves the Christ impulse which is a religion for all humanity. The Christ impulse is impersonal and rejects the castes of the Brahmans, Magi and Egyptian priests. It is universal humanity accepting beggars, thieves and Indian chiefs. It is objective because it recognizes the Christ as a spirit united

with earth evolution and which descended from a celestial sphere higher than Brahman, Ahura Mazda and Osiris. It does not suppress the ego with an aversion for earthly incarnation but raises the ego to work cooperatively within the various groups and nations of humanity towards a common salvation.

Thus, there is necessarily some conflict between the Alpha and Omega sub-races which can be characterized as the personal, detached self path towards salvation and the impersonal, group path of the Christ impulse. Likewise, there is necessarily some conflict between the presiding (formerly Hindu) spirit of the entire fifth root-race and the various spirits of the age for the fifth, sixth and seventh sub-races who evolved during and after the Christ event.

Likewise, there must necessarily be some conflict between the Christ who is a spirit united with all humanity for all future root races and the presiding spirit of this fifth root-race. When during the fourth sub-race (Greek-Roman) the spirit of the fifth root-race appointed the spirit of motion on Mars to lead his epoch as a spirit of the age, the West rejected this appointment and exchanged in his place the Christ spirit, a split occurred between the East and West, the Alpha and Omega. The task of the seventh sub-root race is to unite these religious conflicts.

DESCENT OF MANAS

On another level, we shall see during the seventh sub-race this "marriage in heaven" the unity of the ego and manas. The task of the Atlantean fourth root-race was to prepare the human physical body to become the bearer of the microcosmic ego. For this to happen, a physical event in evolution had to first occur. Prior to the Atlantean flood, no person was able to develop ego self-consciousness to the extent to say "I am". His ego was more closely connected to a common group soul and ancestral memory. By the time of the flood, the physical body had developed to such an extent that the physical event could occur, i.e., the etheric head sank into and merged with the physical head. This physical event made it possible for the human body to carry the descending ego fulfilled by the Christ Spirit.

The task of the Aryan fifth root-race was to prepare the ego for the descent of the microcosmic fifth principle of manas. This preparation took place slowly, spread over the seven sub-races as follows:

- | | |
|----------------------|---------------|
| 1. Hindu/Indian | etheric body |
| 2. Persian | astral body |
| 3. Egyptian/Chaldean | feeling -soul |
| 4. Greek/roman | thinking-soul |
| 5. European | willing-soul |
| 6. Slavonic | Manas |
| 7. Seventh | Buddhi |

In the first post-Atlantean sub-race, the Hindu-Indian culture developed the etheric body as bearer of the ego, as was accomplished with the physical body prior to the Atlantean flood. The ancient Indian could perceive by the forces of the etheric body and this gave rise to the great wisdom of the Vedas and the developed soul forces of the yogas.

In the second sub-race, the Persian culture developed the astral body as bearer of the ego. The astral body being much more active than the etheric body, the Persians performed physical work in developing a material culture, much the opposite of the Indian culture.

Beginning the third sub-race, the ego itself develops through its soul functions of feeling, thinking and willing. The Egyptian - Chaldean sub-race developed the feeling or sentient function of soul as bearer of the ego. These cultures were directed outward towards the stars and their transits. Astronomy arose as a science.

In the fourth sub-race, the Greek-Roman culture developed the intellectual or thinking soul as bearer of the ego. The intellectual achievements of the Greek culture have never really been equaled by a later culture. For this reason Alfred North Whitehead says that the history of Western civilization consists of a series of footnotes to Plato.

Aristotle invented logic. The Romans invented jurisprudence, legislative government and the concept of the free citizen with legal rights. However, for reasons stated in the section on "the culture of 666", the knowledge of Hellenistic culture was suppressed in Europe beginning about 400 A.D. because it was not inspired with the Christ impulse.

In the present fifth sub-race, the European culture develops the willing or consciousness soul as bearer of the ego. The political reflection of this event is the extension of the Roman concept of a free citizen with legal rights to the concept of a personal, individual freedom for each citizen. The rule of primogenitor, where a person inherited his rank in the community, together with the laws of fiefdom, serfdom and fee-tail, all worked against the striving of the individual, conscious ego to achieve status in society. Beginning first in England with the Magna Carta and its Parliamentary forms of government and later in Italy with its free city states, the individual ego actively worked in society releasing the bonds chains of inherited status. The pinnacle of the transition from Medieval government to Constitutional contract government was the American Declaration of Independence and the Bill of Rights. All of the demands of the modern age come from the conflict between the consciousness soul seeking political freedom from the old institutions. In present American jurisprudence, nearly every week, the legal system extends the boundaries of individual human rights in housing, education and social services, particularly in the area of homosexual rights.

Now, within the European culture each nation has its specific mission and this mission is guided by the respective folk-souls as archangels. Folk-souls work into mans etheric body and guide from therein. Physical events being a reflection of spiritual events, the political life of humanity as reflected thru nations is really the spiritual life of folk-spirits. In addition, folk-spirits evolve their principles over time in the same way that individual men and cultures develop and evolve their principles. For this reason every nation represents a certain stage of development of their evolving folk-spirit ego. For example, Steiner says that in Italy and Spain, the national element comes to expression in the feeling or sentient soul. In France, it comes to expression as thinking or intellectual soul. In England, it comes to expression as willing or spiritual soul. In Germany, it comes to expression in the full ego. Eventually, the conflict between the warring folk-souls will converge into a common, unified folk-soul of Europe. Efforts to achieve this is now seen in the effort to create a European Common Market. With the new unification of East-West Germany, the German folk-spirit will gradually transform Himself into a Spirit of the age, leading a unified Europe into the sixth sub-race.

In the future sixth sub-race, manas will descend producing (duality) two will centers of higher and lower manas, as above described, which when evolving into equilibrium, will create the "marriage in heaven" of the human ego and manas. This epoch will be characterized by an agreement between what different people experience as a higher reality in the same sense that people today experience as an agreement of higher mathematical and geometric axioms. As fortold in THE APOCALYPSE OF ST. JOHN, this culture of Philadelphia will bring peace and brotherhood thru a common wisdom that "hath the key of David".

Steiner refers to the descent of Manas in the sixth epoch as the three days of initiation. In the GOSPEL OF ST. JOHN(1908) he comments on the prophecy from this gospel, "on the third day there was a marriage in Cana of Galilee". The first day of initiation was the transition from the third to the fourth cultural epoch. The second day of initiation was the transition from the fourth to the fifth epoch. The third day of initiation will be the transition from the fifth to the sixth epoch. These three days of initiation correspond to the three days of entombment in the ancient Mystery Schools the candidate spent under the spiritual guidance of the hierophant. The marriage in Cana corresponds to the marriage in heaven of higher and lower manas with the mature Christ impulse.

These three days of initiation also correspond to three historical ages. The first representative of the Father as the age of the Old Testament. The second representative of the Son as the age of the New Testament. The third, beginning the 20th century, as representative of the Holy Spirit.

In the future seventh sub-race, Buddhi will descend upon a community of free and independent egos. This is referred to in THE APOCALYPSE as the Church of Laodicea which forms a stream in humanity of warring, fighting egos, unable to unite and harmonize conflicting social and personal interests and desires. The other stream in humanity is represented by the brotherhood of the Church of Philadelphia, whose foundation will be laid down in the sixth epoch.

At the close of the seventh epoch these two streams will do battle in what is called the "great war of all against all". At the close of the fourth Atlantean age, civilization was destroyed by the great flood. So will the civilization of the fifth Aryan age perish by the great war. As occurred at the end of the Atlantean age, the great Manu will lead a small group of highly evolved persons out of the ashes to populate a new civilization of the sixth root race.

WHAT IS ISLAM ?

(The other Son of Abraham)

Islam is the fastest growing religion on the planet. In our century, the great french intellectuals, Frithjof Schuon, Rene Guenon, Titus Bruckhardt and Henry Corbin, have fallen away from Christianity and embraced with open hearts the Islamic revelation.

Bruckhardt says, "Islam regards itself as the renewal of the primordial religion of Humanity." Schuon says, "Islam integrates Christ in its perspective...According to this perspective, the Word does not manifest itself in any particular man as such, but in the Prophetic function-in the highest sense of the term-and above all, in the revealed books: and since the Prophetic function of Mohammed is real and the Koran a true revelation, Moslems, who admit only these two criteria, see no reason for placing Jesus before Mohammed. Indeed, they must give precedence to Mohammed, in as much as the latter, being the last representative of the Prophetic function, recapitulates and synthesizes every aspect of this function and CLOSES THE CYCLE ON THE MANIFESTATION OF THE WORD."

Schuon further says that the three monotheistic religions, Judism, Christianity and Islam, are all religions of the Prophet and the revealed book(s). Excepting the Mormons, it is true that Mohammed is the last prophet of the cycle. Schuon raises the following grave issues for Christians.

Why should Christianity be considered the "true religion" , when it is, admittedly, not the final one of the cycle.

Why should Christ as a prophet and His books (the old and new Testaments) of the Divine Word be given precedence over other revelations, when both Christ and His Revelation can wholly be integrated into the Islamic paradigm, which extends from Adam, thru Abraham, to Mohammed?

Why should Christianity continue the priestly functions of the sacraments, when the historical necessity of the division between royal and sacerdotal functions has virtually been eliminated by the rise of Democracy and women in the (protestant, anyway) priesthood? Islam has eliminated the need for a priesthood, since every Moslem is everywhere a priest within his own religion. "It matters little to him whether or not he is externally severed from the Moslem community; he always remains his own priest and an autonomous unity." Every Moslem can perform the essential rites of his religion, personally, by himself.

It is clear to me the reason the great French intellectuals have left the Christian community is that Islam is a "spiritual, religious and social block" that has solved the historical problems of the Prophet, the Word and the priesthood. Like no other religion, Islam is a complete unity and perfect monotheism. So say what you Christians about that? Well, I might only retort that the Bodhisattva of this century converted to a Roman catholic!

To evaluate this dilemma, I would say first, that Schuon is wrong to call Christianity one of the three monotheistic religions. There is NO what he terms, "Ternary Aspect of Monotheism." With its Trinity, Christianity is not strictly monotheistic, as it resembles all religions of the third cultural epoch that reflect the recapitulation of the sun-moon-earth evolution in the form of a trinity.

The reason why Islam is so popular and powerful is that it replaced Judaism as the only monotheistic religion on the planet. As Dr. Steiner says in *THE MISSION OF FOLK SOULS* (1910),

"There are two spiritual currents in mankind. The one must be called, that which proceeds from plurality, Monadology, which conceives the origin and source of existence as consisting primarily of a number of beings and forces. (Thus we have the Hindu) Brahma, Shiva and Vishnu (and the German) Odin, Hoenir and Loedur. This is the current which, because it proceeds from a number, may assume the greatest possible variety.

"This worship of many HAD to be opposed by a synthetic, all comprising movement which proceeded strictly from the Monon, Monism. The actual inspirers, the impulse givers of all monotheism and monism, of the worship of a single divinity, are the Semitic peoples... It is in their nature, it is in their blood, to represent the one God, the Monon. The other peoples have pluralistic impulses."

Looking at this dichotomy of monism vs monadism, Christianity certainly is pluralistic in its Trinity, contra Schuon. Steiner even confirms this when he says, "the monon in India was soon divided into a trinity, as the one God of Christianity is divided into three persons." The key to understanding these two spiritual currents of humanity is that the schism creates a "great polarity" between pluralism and monism and we know that evolution on the physical plane always proceeds thru a duality of yin-yang. Here Dr. Steiner states the key-

"Monism is not possible without pluralism and the latter is not possible without the former. Therefore, we must recognize the NECESSITY FOR BOTH."

This is the rule for spiritual evolution on the physical plane.

Now, what happened to the monistic impulse of the Jews? As Steiner has said many, many times and Schuon re-emphasizes as follows:

"The monotheistic religion belonged originally to the entire nomadic branch of the Semitic group, a branch that, having issued from Abraham, was subdivided into two secondary branches, one issuing from Isaac and the other from Ishmael, and it was not until the time of Moses that monotheism took a Judiac form: it was Moses who, at a time when the religion of Abraham was growing dim among the Ishmaelites, was called upon to give monotheism a powerful support by linking it in a certain manner with the people of Israel, who thus became its guardians. It may thus be said that Judaism annexed monotheism and made it the possession of Israel."

Obviously, the line of Isaac has terminated with what Schuon calls "Christ put a final term to the religion of Moses." This is very true but for the wrong reasons.

In that most profound treatise of revelation, *THE MISSION OF FOLK SOULS*, Dr. Steiner explains why certain civilizations rise to a pinnacle but suddenly, almost overnight, crumble away into cultural diaspora. For the Celts, their guiding archangel renounced going to the higher level of a Spirit of the Age. Instead, he sacrificed himself and became the "inspiring spirit of Esoteric Christianity." Likewise, the Greek archangel renounced his ascension to this higher level to become the "guiding spirit of Exoteric Christianity." As a result, both Celtic and Greek nations "crumbled away so quickly."

Here is another occult law of spiritual evolution. Every nation is guided by its archangel, who lives and evolves himself within this cultural-linguistic group characteristic of a nation. When the folk-spirit leaves his folks, by reason of either, (1) renunciation or (2) the normal evolution of the rise and fall of civilizations, the folk, without a center, crumbles away into diaspora.

The Celtic and Greek diaspora are two examples of renunciation. The other process is one of normal evolution, when the guiding archangel, lives in unity within his folk culture, thru the rise and fall of its civilization. Then, the archangel matures and leaves his folk of his own volition, in order to continue his evolution in the higher spheres of the angelic hierarchy. Scattered around the planet are pockets of "remnants of former cultures" such as the Polynesians in the Pacific ocean, the Indians in the Caribbean and the American Indians. These groups are the remnant diaspora of the former Atlantean races and sub-races whose guiding archangel matured and voluntarily left many thousands of years ago. Contrast this situation with the genocide of the native Indian of 19th century Argentina, which results with, of course, no remnants left over.

The archangel of these remnants did not desert their folks in any negative sense. To the contrary, their archangel, having completed his evolutionary task assigned to him, departed and rose to the level of a Spirit of the Age, as a normal process of evolution thru the angelic hierarchies. We know the Divine Plan of the Spirits of Form was to have each of the seven Atlantean races evolve consecutively, one after another. However, because of the interference of the Planetary Spirits of Motion, evolution of the successive races was held back, held over. Thus, the Divine Plan of the Spirits of Form was to have, for example, the Toltecs, to evolve in their normal course, the rise and fall, the ascending and descending phases. But, when the descending phase was historically and chronologically completed, this race was not terminated (yes, in the genocidal sense of the word), but certain peoples remained over. So in the Americas, for example, we have small groups of "held over" sub-races, such as the Mexican and American Indians, who struggle to survive, without the spiritual guidance of their archangel. At least, the American Indian acknowledged that their Great Spirit was dead. As V.S. Naipaul has correctly observed, the Carribean peoples of Central America will never have a cohesive social and political culture. They can not ever, being a surviving remnant of a former great civilization, that should have been extinct when the deluge waters of the Biblical flood submerged the Atlantean continent.

I know that this analysis sounds harsh and I do not want to be accused of fostering genocide, but the Divine Plan of the Spirits of Form is an example of what the ancient Egyptians called the "Iron will of necessity."

For the Jews of the third cultural epoch of the Aryan fifth root race, the situation is even more dramatic and complicated. First, at the angelic level, there was an inspiring folk-soul, Elijah, who was not merely the normal angel, aspiring to rise to the level of arch-angel. He had the (miraculous) powers of an archangel who had descended to the level of an angel. Dr. Steiner speaks of the origin of this folk-soul: "For such an individuality, provision is made in the Mother-Lodge of Humanity. Such an ego was born into the body under the immediate guidance and direction of the great Mother-Lodge of Humanity in the central sanctuary of earthly spiritual life. The John (Elijah) ego descended from the same holy region as that from which the soul-being of the (Nathan) Jesus child descended." In each of his incarnations as Phinehas (son of Eleazar), Elijah-Naboth, Elijah-Elisha and St. John the Baptist, he rescued the fallen group spirit of the people and restored its vigor to fulfill their karmic mission.

At the arch-angelic level, Michael was the guiding folk-spirit, who received orders from the higher Archai and give orders to his folk-soul. He was also more elevated than the normal archangel, being a sun spirit and acting as the countenance of Jehovah. The corresponding Spirit of the Age was the Greek Archai, which had basically fulfilled his task by the end of the Golden Age of Greece.

In normal cultural evolution, when we approach the second angelic hierarchy, there is no direct correspondence between the nation and the guidance from the Spirits of Form and Spirits of Motion. These higher spirits normally work equally thru all nations of a race or sub-race. However, with the Hebrew nation, Jehovah-Elohim, as a Spirit of Form worked directly in the Jewish blood from Abraham, thru the 3 X 14 generations of the Matthew Gospel, to the birth of Jesus.

At the level of the Planetary Spirits of Motion, the Semitic race belonged to the Mars race-spirit. Again, there is not a normal relationship here. The Mars Spirits themselves work directly thru the blood producing the Mongolian race. However, in order for Jehovah to intervene and work directly thru the blood, a special cooperation had to be reached between the two spirits, so that Jehovah ALONE and not the Mars Spirits, could have exclusive influence over the Hebrew nation.

Thus, throughout the second and first angelic hierarchies, all angelic beings worked cooperatively for the great karmic task of the evolution of the Semitic race; which in the Abraham-Isaac line would bear the incarnation of the Christ and in the Abraham-Ishmael line which into the future would continue the monotheistic tradition of the Prophet and the Word. The special angelic beings who guided this mission were:

Elijah angel	Folk-soul
Michael arch-angel	Folk-spirit
Greek Archai	Spirit of the Age
Jehovah-Elohim	Spirit of Form

Mars/Jehovah

Spirit of Motion

Now, as Schuon says, the Christ event ended the prophetic cycle of the Abraham-Issac Semitic line, but as I have said, for the wrong reason. The real reason was that the "Mission Impossible" accomplished, the special alliance of guiding spirits served its Divine purpose and was therefore disbanded. Elijah has had at least two subsequent incarnations, as Raphael and Novalis, but these are not connected with the Hebrew race. Michael has withdrawn his leadership in preparation for his Regency as Spirit of the Age beginning 1879. The Greek Archai renounced and lives on as the inspirer of Exoteric Christianity throughout the future Spirits of the Ages. Jehovah had ascended the angelic ranks and the Mars Planetary spirit had resumed his former activity as a race spirit. With these angels leaving in the normal course of evolution, Jewish diaspora resulted, with the destruction of the Essene monastery in Qumran and the razing of the Temple and city of Jerusalem in 70 AD.

Mission Impossible accomplished, was the departure of the leading Jehovah spirit the end of the monistic impulse? No, the Spirits of Form, in their infinite wisdom, had a back up plan preserved in the Semitic line of the other son of Abraham, Ishmael. For a new monistic impulse to be implanted, the remaining Semitic peoples were the best suited for two reasons. First, the blood line had been worked over for the 3 X 14 generations by Jehovah. Second, the monistic tradition of the prophet and the book of the Word had also existed since the time of Moses. Islam as the direct descendant of the duplicate Semitic line from Abraham was the best suited to integrate these two traditions. They need only to eliminate the priesthood which was destined to extinction anyway as a penalty for the crucifixion of Christ.

In conclusion, Islam is the logical conclusion to the other Adam-Abraham-Ishmael line established by Melchisadek as the bearer of the monistic impulse. As a religion of fervent monotheism, Islam will necessarily conflict with its closest pluralistic religion, Christianity. It will most likely be the source of the anti-Christ. However, Christianity and Islam should stand side by side, like neighbors with a good fence, and recognize a respect for each other. The spiritual development of humanity needs and requires this eternal duality.

RELIGION (conclusion)

I

While it is true that the leading mission of the Fifth root race is the development of Manas on the physical plane, it is equally true that the development of this thinking faculty proceeds hand in hand with the cultural evolution of religious forms on the same plane. The Atlantean Age was first and foremost an evolution of the diversity of human races thru their etheric bodytypes. In our Fifth Aryan root race, diversity of races falls into the background, while religious evolution proceeds in the foreground thru its septenary forms. Dr. Steiner was absolutely correct in disagreeing with the Good Madame H.P. Blavatsky and her Theosophists, that religion, not racial diversity, continues thru the Fifth Age.

Hand in hand with religious evolution comes cultural evolution. This is why Dr. Steiner renamed the seven Theosophical epochs of the Fifth Age as cultural epochs and not as racial epochs. Each cultural age is commenced with a theophany, a religious revelation of the prophet and his book, the logos. Thus, for the Hindu revelation, we have the group revelation of the prophet thru the Seven Rishes and the books of the Vedas. For the next epoch, we have the revelation of Zarathustra and his book, the Avesta. During the third epoch, we have the revelation of Hermes and what survives of his 42 texts, such as the Emerald Tablet, the Poimandres, etc. Also during this third epoch we have the beginning of the monotheistic impulse of the Father, in the prophet Moses and his books, the Pentateuch. During the fourth epoch, we have the Christ as greatest of all prophets and the books written for Him, the New Testament, Acts and Letters of the Apostles and the Apocalypse, written by His initiate, St. John. The esoteric seeds of this greatest of all revelations lies both in the Angelic Hierarchies of Dionysius the Aeropagite and the so-called (by Joan of Arc) Book of God, which is the preserved etheric tableau of the life of Christ, which is seen by the various Saints and most recently by Sister Emmerich.

With the diaspora of Jewish monotheism, we also have in the fourth epoch the renewed impulse of the Father thru the prophet Mohammed and his book, the Koran. Although not discussed before in ISLAM (infra), Dr. Steiner feels very strongly that the "number of the beast" from the APOCALYPSE of St. John has risen in this culture of "666" in Islam. "The streaming of Arabism towards Europe, wherein Christianity became permeated by a teaching which could only make men fail to see their humanity within themselves; where the Father dogma is controverted into naturalism." For Steiner, this renewed monotheistic impulse of the "Father as natural laws" is directly in opposition to the Son dogma of Christianity and with it, of course, the Spirit dogma completing the Holy Trinity. Furthermore, this Islamic impulse is the direct inspiration of the Sun Demon, Sorath, working thru the elemental forces of Ahriman. The date of the 666 appears first in the Mohammed revelation, set off in the shape of a crescent, as an opposition to Christianity, then again in 1332 with the genocide of the Templar impulse and will appear for the third time at the end of our century in 1998. As the sun is the balance between the earth and moon, so is Christianity the balance between the earthly forces of Ahriman and the remaining over Old Moon forces of Lucifer. The Christ

revelation is the middle of that sliding scale of earthly materialism on one side and extreme lunar spiritualism on the other side. For this reason, Islam will always be the religious and cultural antithesis of Christianity and Western culture.

The fourth epoch is that time when a new impulse arrives, in this case, in the two impulses of Christianity and Islam. The fifth-sixth-seventh epochs will be a repetition at a higher level of the impulses given during the first three epochs (as observed by Harrison) wherein the esoteric seeds will bear fruit within the exoteric plant of existing religious forms. There will be per-se no new religious forms arising but there will be renewed impulses within the existing forms.

For example, we see in the last century the new Christian impulse of the prophet Joseph Smith and his book of Mormon, revealed by the angel Moroni. Mormon cures many of the traditional ills of the Christian dogma, particularly those errors of the many Protestant faiths. Remember, the Protestants have neither a prophet nor a book, their main purpose being to print the book (Bible) of the Christian revelation which the Catholics, like the ancient Jewish priests, kept in secret. This book of Mormon restores the body-soul-spirit tricotomy that was eliminated at the Church Council of Constantinople in 869 AD. It also teaches of the pre-existence of the soul in spiritual worlds prior to incarnation at birth, which is a timely renewal of the Platonic doctrine over the Aristotelian contribution to Catholic dogma. In addition, it teaches of the individuality of the three persons of the Holy Trinity, separate in person, but united in purpose within the Trinity. These three truthful and important doctrines which were put aside for good reasons by the early Catholic church, are now being restored during the Age of Michael.

Because the religious revelation is inherently a cultural impulse also, it is appropriate to speak now and in the future of cultural evolution as the hallmark of the political evolution of nations. For the first time in university academics, we see this wisdom pour out in the recent book by Samuel P. Huntington called *THE CLASH OF CIVILIZATIONS AND THE REMAKING OF WORLD ORDER*. Here he makes the case that the war of political systems and ideology is over and the wars of cultures has begun. The tectonic plates of the new world order are seven or eight cultures; the Western, Eastern Orthodox, Islamic, Latin America, Japanese, Chinese, Hindu and possibly the African.

These cultural groups are indeed close to our historical cultural epochs. The Eastern Orthodox is of course, our next sixth cultural epoch of the Slavic/Russian. For the reasons discussed (*infra*) in ISLAM, the Latin American is not a cultural force since these peoples are the remaining diaspora left over after their guiding archangel departed, during the last Atlantean Age. However, South America will indeed be a cultural force in the future seventh cultural epoch. China is not regarded as a religious culture since its Mongolian race is a renewal of the seventh sub-race of the last Atlantean Age, which by definition is pre-religious. They are a culture of ancestor worshippers not god worshippers. Guenon says that there is a Far-Eastern religious tradition that dates from the 6th century BC, this being the time of Lao Tzu and Confucius. Later, the tradition was separated into esoteric Taoism and exoteric Confucianism. It is foreseeable that the exoteric tradition could assume the Buddhist religion, as did Japan, and in this case China could be considered both a religious and cultural front. In any event, China is a huge cultural group which has a destiny with the first cultural group of the fifth Aryan root race, the Hindus.

Mr. Huntington's critics point out that there are still significant political conflicts that derive from other than tradition, culture and religion. For example, what should have been a culturally united Western Europe certainly did not prevent itself from slaughtering millions of persons during the last two World Wars. This is true, but the newly founded European Common Market should form a lasting cultural community, provided the German archangel does not still seek to become the Spirit of the Age.

Likewise, critics point to the war in Afghanistan which began as a war between Russian and Islamic cultures but has since now divided into a war within Islam itself. The Sunnis are fighting the Shiites, city Muslims are fighting the rural Muslims and at least four regional Islamic powers are fighting for control. Again, this is also true, but over time, these internal conflicts will work themselves out and there will be a unified victor.

This Afghan example points to a higher wisdom concerning the nature of the archangels who control national and cultural evolution. On the one side, the forces of Ahriman on the physical plane manifest division within any human/religious community and on the other side, angelic evolution proceeds from unity thru stages of diversity. Apart from Ahrimanic influences, diversity is the manifestation of forces reflecting down from the higher angelic hierarchies. The exoteric revelation given to the peoples can only become diversified and every religion reflects this principle.

Within Christianity there is the ternary division into Roman Catholics, Eastern Orthodox and Protestants and we may now be witnessing a manifestation of a future septenary in the coming fourth impulse of the Mormons. Within Islam, the division between Sunni and Shiite has existed since the first generation of Mohammed and I am sure we will live to see a third division emerging as Islam increases its sphere of influence. It is the fastest growing religion on the planet. In contrast, Hinduism has been esoterically sevenfold since its inception. Within its ranks there is even

a monotheism trend in the strict vedantic sects of Sankara in the 9th century, and the Islamic-Hindu trend of Kabir and Guru Nanak in the 15th century. All religions naturally diversify and the above Afgan criticism is no more than an observation of the normal evolution of archangelic ternary and septenary evolution.

When Huntington speaks of the present and future dominance of cultural and religious conflict, there is no better example than what recently happened in the college town of Lincoln, Nebraska. A 39 year old gulf war refugee married off his two age 13 and 14 daughters to two fellow Iraqi refugees, aged 28 and 34. The ceremony was performed in full Muslim tradition with cleric, family and friends. When one of the young wives ran off to a shelter, the city cops came in and put the two wives in foster homes. Then, the police arrested five adults and charges are pending for crimes ranging from child abuse to rape. The two husbands who consummated their marriages are facing rape charges and 50 years in prison. Now, that is religious and cultural conflict the critics should talk about.

II

Another aspect to consider is what is the relationship between this national/state entity impulse and religion? As we said before, the purpose of the 5th Aryan Age is two fold: first the development of religion and second the descent of manas into the physical plane. the descent of manas entails the rise of the state in opposition to the religious impulse.

In the Atlantean age, there was no need for religion because each person lived directly in the spiritual world. During sleep, one could directly experience the hierarchies of the spiritual world and during the day consciousness, one was directed by the impulses that were received during the night. For this reason, the Atlantean age was an age not of religion but of ancestor worship. This is clearly seen anthropologically in the remnants of the Atlantean Age, for example in the Chinese and Polynesian cultures. With the descent of manas during the 5th Aryan Age, mankind thru its intellect, drew away from the direct experience of the spiritual worlds and religion became necessary for mankind to maintain a direct link with the spiritual worlds. The religious impulses from the book and the prophets of the worlds great religions are great gifts from the gods to humanity. As i said before, the decline of atavistic clairvoyance and the rise of the cognative faculty of mind are inversly porportional, as is also the case of the detachment from the 4 group souls and the rise of the individual ego.

The evolution of the nation/state as organizing principle of cultures runs hand in hand with the descent of manas and counter to the principle of religion as organizing principle of cultures. As recent book review of a Marcel Gauchet's book THE DISENCHANTMENT OF THE WORLD says that "sometime around 3000 BC, somewhere in Mesopotamia and Egypt, a parting of the ways took place, with a social ordering that was seen as originating in individual human wills and individual human wills perceived as themselves existing prior to the social bond (of religion) that holds them together." This impulse in Egypt came from the building of the pyramids which was the first time society was organized for a great purpose.

It is no coincidence that also around 3000 BC Dr. Steiner says that mankind suffered an incarnation of Lucifer. Although the place of this incarnation was in the far east, the impulse was quickly transplanted into the western Egyptian/Summerian area as the first experiment in the organizing principle of nation/state. (a similar experiment also took place in the 20th century with the transplanted impulse of communism in Russia). The emergence of the nation/state is a luciferic impulse of ordering individual human wills and the building of the pyramids was the first rebellion against the principle of religion as ordering individual human wills. These impulses are again inversly porportional in that great bell curve of human evolution during the Aryan Age. The other pole of Monotheism as such is also an impulse towards the totalitarian nation/state.

III

After long cycles of diversity of religious manifestation, what brings about a unity of religions ?

It is as Frithjof Schuon observed, the esoteric unity of all religious revelation that binds people together in eternal truths. Looking as he does at all religions in the shape of a pyramid with god at the apex, at the higher esoteric level all religions converge towards the apex and below at the exoteric level, all diverge. What leads back to unity is the gradual revelation of universal truths from the esoteric core or seed that lies behind every religious theophany. For Christianity, Spiritual Science and Anthroposophy reveal the core of religious truths that will lead all Christians to a common ground for only in the universality of truth is there unnamimity. In Islam, we now see the esoteric core being peeled back thru the works of Henry Corbin and S.H. Nasr.

Esoterism is the path of truth that leads to religious unity. "For the exoteric, God is primarily loved, for the esoteric, He is primarily known." This is why Dr. Steiner says, "Christianity has begun as a religion, for humanity (in our Aryan Age) was founded on religion. Yet religion must be replaced by wisdom, by knowledge. In so far as religion rests upon faith and is not inflamed with the fire of knowledge, it is something that must be replaced in the course of humanity's progress." This replacement process will slowly occur because the goal of the Aryan fifth Age is both: (1) the descent of Manas and (2) the septenary evolution of religious forms, together. Manas gives knowledge to the exoteric religious experience. "From religion, mankind evolves to wisdom glowed through by love."

If humanity evolves to achieve the final esoteric unity of religions, why will Christianity become the universal final solution for all believers ? It is because of the appearance of Christ in the etheric beginning in year 1933. As Schuon correctly observes, the process which causes separation in the kingdoms of nature is reversed for the kingdom of mankind. He says "That which unites the being and more particularly the realized being to the Divine Principle, is the intellect; that which separates the world-or any microcosm-from the Principle is existence...the metaphysic proceeds exclusively from the intellect...the universality of esoterism is the same thing as the universality of metaphysic and is itself of a universal order, and not, like reason, of an individual order." This universal order of intelligence to which Schuon refers is the same Cosmic Intelligence of which the Islamic tradition is fully aware thru the writings of Avicenna and Averroes. In the Western tradition, Steiner refers to this as the descent of Manas on the physical plane during our Aryan Age which began in 869 AD. It represents the sacrifice of the body of an angelic being spread over humanity and as part of an universal order, its benefits will be available to everyone. In the future, Manas will become organic and transmitted thru heredity in the same way that the ego, astral body, etheric body and physical body are now given to mankind. When in the past, one had to raise his consciousness to the level of the Cosmic Intelligence to receive the esoteric revelation, in the future this will be commonplace. However, therein lies the danger of the unpurified astral body which receives the Manas revelation. The purpose of the Christ revelation was to insure this occurs in a being infused with love. With the appearance of Christ in the etheric, those persons who attain the esoteric revelation, either now consciously thru their personal effort or, in the future, unconsciously thru the descent of Manas, will find in the etheric not the Buddha, the Confucius, nor the avatar, nor the Maitreya Bodhisattva, but the Christ being Himself, in all His Divine splendor. For persons of all different religious persuasions, the experience will be the same, the perception of the Christ being. This universal experience will finally unite persons around the world in a common religious experience. Certainly, other persons will perceive other various spiritual beings of different angelic orders other than the Christ, but for these persons, the experience will not be universal, it will be as individual as is the different beings experienced. Only with the experience of the Christ being will the religious experience be universal. This is also the reason that the Christ being returned to the etheric plane and not to the physical plane as incorrectly predicted by those evangelists of the second coming. Had Christ returned in a human body to the physical plane, the same problems would occur as did when He incarnated in Judea. Because of the "diversity of Existence", as Schuon observes, some people would accept Him and some would not. The return to the physical plane could not accomplish a universal experience common to all humanity for those who seek the religious truths. In the end, the varieties of all religious experience will be reduced to the single experience of the Christ in the etheric. Of course, to cement this man-God experience, Christ will again appear in the future sixth and seventh cultural epochs within the astral and devachanic planes.

DIONYSIUS THE AEROPAGITE

On the hill of Mars, St. Paul lectured to the philosophers and judges of the Aeropagus and two named converts left with him, one was that man Dionysius referred to in Acts 17:34. Who was this man that later wrote in a letter to Polycarp?

"What have you to say about the solar eclipse which occurred when the Savior was put on the cross.? At that time the two of us were in Heliopolis and we both witnessed the extraordinary phenomenon of the moon hiding the sun at a time that was out of season for their coming together, and from the 9th hour until evening it was supernaturally positioned in the middle of the sun. We saw the moon begin to hide the sun from the east, travel across to the other side of the sun, and return on its path so that the hiding and the restoration of the light did not take place in the same direction but rather in diametrically opposite directions."

So began the conversion of Dionysius to Christianity. But his conversion was not from just that of a pagan to a believer, but, like to the experience of St. Paul on the road to Damascus, from the depths of the pagan mysteries unto the most sacred heights of the essence of the Christian mysteries. Dr. Steiner lectured that Dionysius was a most profound pupil of the christian mysteries taught by St. Paul at the School of Athens. Although there is no exoteric historical record of this first mystery school, it is certain that what was taught there was preserved in the CORPUS AREOPAGITICUM attributed to the Dionysius, of Acts 17:34. These books include the Mystical Theology, the Divine Names, the Ecclesiastical Hierarchy and the Celestial Hierarchy, plus a few collected letters. For the few centuries that passed after the death of Paul and presumably Dionysius, the CORPUS remained hidden in the Christian East until first reference was made to it in a report entitled "Epistle of Innocent the Maronite

concerning a conference held with the Severians." This report was based upon a debate between Hypatius of Ephesus and a group of Severians over the decrees of the church Council of Chalcedon in 451. It had happened at this church Council that, before he had arrived to defend himself, Nestorius was declared anathema by the church. The Council was called to declare heretic the doctrines of Nestorius which have been historically grouped under the term 'monophysite', meaning the single god-man nature of the incarnate Logos. The duophysite nature, proclaimed by Athanasius, meant that Jesus was both fully man and god, in one undivided nature, sort of two-in-one. This Council preserved for the Roman church, the dogmas of the virgin birth of Mary as well as her place as the unblemished mother of Jesus. For Nestorius, both Mary and Jesus of Nazareth, were natural persons until the baptism by John in the Jordan, during which event, the Father incarnated in the person of Jesus. Jesus did not beget his divine nature until the baptism, after which He became monophysite, one nature as God-man. Severus (465-538) and his followers were east Syrian Christians of the Nestorian variety and any quoting of Dionysius in their defense also worked anathema against Dionysius. In addition, several other passages in the volumes of the CORPUS dealing with the nature of the trinity and the nature and number of sacraments were questionable in flavor and suffered the danger of also being called heretical to the Roman Council. To rectify this situation, a certain John of Scythopolis in Palestine began writing glosses of commentary on the CORPUS, explaining away the controversial passages with alternative meanings and where necessary, making editorial changes. Another church father, Maximus the Confessor, also contributed significant explanation and defense of the Dionysian texts. As a Eusebius also identified the Dionysius of Acts 17:34 as the first Bishop of Athens in his Ecclesiastical History, which was well respected its accuracy of apostolic succession. Thus, over time and believing the all important link to St. Paul, the number of high ecclesiastical authorities coming from monasteries all over the east in support, the CORPUS was saved from contagion with the Nestorian heresy and became orthodox theology in the Eastern church. So much so, that with the help of Maximus, the Lateran Council in 649 cited Dionysius as a witness against monotheism.

As the American scholar Jaroslav Pelikan commented, the first odyssey of the CORPUS AREOPAGITICUM was to be saved from "the heretical East to the Orthodox East, the spirituality of this 'Maximized' Dionysius having been purged of any lingering suspicions about his orthodoxy, well before the time of his second odyssey, from the Orthodox East to the Catholic West." This second odyssey to the catholic west began in 827 when the byzantine Emperor Michael II (the Stammerer) sent a legation from Constantinople to the Frankish Emperor Louis the Pious bearing gifts and a copy of the CORPUS AREOPAGITICUM. A certain arch-chaplain friend of Louis named Hilduin of the St. Denys monastery near Paris made the first western translation of the CORPUS into Latin in 838. This translation was unintelligible and later King Charles the Bald ordered John Scotus Eriugena to make another translation which was finished in 862. John, coming from the schools of Ireland, had suddenly appeared in the court of Charles in 847 and was quickly appointed head of the palace school. Although not known to travel to Greece and the east, he was well versed in greek and soon became very influential in the court. The lack of imagination that plagued the translation of Hilduin, soared in the mind of John, who had a kindred spirit with Dionysius. He understood the nuances of greek, wrote annotations and in his own theological writings, highly praised the CORPUS, which advanced both author and translator with the sudden popularity of the texts.

Now for the first time the problem of the PSEUDO-Dionysius came into existence. In his translation of the monastery's text, Hilduin also wrote an hagiography and identified Dionysius with St. Dionysius (or Denys), the first bishop of Paris. Now, there were three Dionysius, the first was Dionysius the Aeropagite of Acts 17:54 and Eusebius Bishop of Athens; second, the Dionysius identified by Dr. Steiner, who was the pupil of St. Paul at the Academy of Athens, and the third, the martyred Bishop of Paris and patron saint of France who died some 100 years later than any contemporary of St. Paul.

I would offer the following explanation. First, with Dr. Steiner's identification of Dionysius as a pupil of St. Paul, this is most likely a well kept esoteric secret of the medieval monastic life, particularly of the Cistercian variety. I may refer the reader to the famous painting of Raphael of the Academy of Athens and ask why not the two figures actually being St. Paul and Dionysius and not the presumed Aristotle and Plato. Second, we have it from good sources, notably, Babai the Great, who in the 7th century, wrote commentary on the DIVINE NAMES and called its author "Saint Dionysius disciple of Paul." (Babai 569-628 was a wealthy Persian christian who studied literature and went to Nisibis and studied medicine. He later became the head of the monastery of Mar Abraham on Mt. Izla and was considered the greatest divine theologian of the Eastern Nestorian church and has been considered the first sufi) The Academy of St. Paul at Athens was the first esoteric christian mystery school that bore the wisdom of the risen Christ as experienced by Paul on the road to Damascus. In addition, Paul most likely spent some of his three years in the desert in the monastery at Qumran where he learned the angelology of the Essenes which was passed down from the master Zarathas during the Babylonian exile. In the Jewish tradition, Paul's teachings, preserved by his pupils, bore the ancient wisdom of both the celestial hierarchy as well as the divine names. As is well known in any initiatic

school, the hierophant bears the name of its founder and each succeeding master continues this tradition. That the first Dionysius of Acts 17:34 died and passed his astral and etheric mantle to his successor is presumed tradition. That this successor bore the same name, had no historical biography until he moved to Paris, where he became bishop and martyr is also likely (similar to what the risen Lazarus accomplished in Ephesus). As is ancient custom, the church of St. Denys bears both the name and the relics of its founder. Most likely also, the monastic order at this church preserved the oral teaching of the Athens school for 700 years until a written copy of the CORPUS AREOPAGITICUM magically appeared in 838 from the east. Unfortunately, the priesthood at St. Denys church were incapable of giving the divine texts their rightful understanding. Fortunately, for western christianity, John Eriugena was the right man in the right place to water this seed from Constantinople. A similar seed blossomed in Europe 600 years later when Gemistos Plethon again came over from Constantinople with the major greek texts to the court of Cosimo De'Medici, whence began the renaissance.

The second odyssey, from Orthodox East to Catholic West, was now complete with the new translation and publication by John, who said of these texts, "The Mystical divinity ran across England like deer." Well, the current was more underground than aboveground, since very few references to the CORPUS were made during the next several centuries. However, as we have heard before, the 12th century was a mini-renaissance. In 1165 a certain John Sarazin, a monk at the St. Denys monastery, made a new translation of the CORPUS with commentary which became dedicated to "Master, John of Salisbury" also known as John of Chartres. In the KARMIC RELATIONSHIPS lectures (Vol.III) Dr. Steiner spoke about the great Platonic revival that occurred at the School of Chartres thru the monks of the Cistercian order. Great teachers like Alain de Lille, Bernardus Sylvestris and Bernard of Chartres taught of the creative powers of the Goddess Natura as a living being and of the Goddesses of the seven Liberal Arts, who also, were real, living spiritual beings. Although the real founders of the Cistercian order, St. Bernard of Clairvaux and William of Saint Thierim, were not greatly influenced by the CORPUS, it flourished in Chartres and poured itself into the Order. And after the death of these great teachers, Dr. Steiner said,

"The last great ones of the School of Chartres had just arrived in the spiritual world...and at the beginning of the 13th century there took place one of the most important exchanges of ideas behind the scenes of human evolution, an exchange of ideas between those who had carried up the old Platonism, inspired by spiritual vision, from the School of Chartres into the spiritual world, and those on the other hand who were preparing to carry Aristotelianism down to earth, as the great transition to bring about a new spirituality that was to flow into the evolution of mankind in the future....It was a truly living cooperation, the great Alain de Lille (1120-1202) sent his pupil down to continue through the Dominican Order the task that was now to pass over to Aristotelianism."

With the Dominicans, Albert the Great and St. Tomas Aquinas, the great age of scholasticism began, which was that world historic perfect blending of Plato and Aristotle, faith and reason, and for the future, faith and science. The fact that St. Thomas made over 1700 references to the CORPUS AREOPAGITICUM and that (another celestial architect) St. Bonaventure called Dionysius "the prince of mystics" has forever made the CORPUS dogma for the western catholic church.

The CORPUS also found its way into the great mystics of the middle ages, including Master Eckhart, Tauler, Ruysbroek, Gerson, Nicholas of Cusa, Denis the Carthusian, St. John of the Cross, Francis of Osuna and Harphius. After that second burst of Platonic revival occurred into the 15th century renaissance, Marsilio Ficino took time from translating his Hermetic and Greek texts and made a new translation and commentary in 1492. Taken up by the Florentine Academy, Dionysius again 'spread like deer' across Europe along with the translated Gemistos Plethon texts reaching even Protestant countries like Germany and England. It was reported that the thrice-great Trithemius, Abbott of Sponhein, became completely absorbed in copying and translating Dionysius. I can imagine this kindred spirit going absolutely bonkers over the Celestial Hierarchy such that the Abbot never touched ground again. Unfortunately, with the spread of the humanist Protestant reformation, the second odyssey with the problem of the PSEUDO-Dionysius began in earnest. The first critic, Lorenzo Valla (1407-1457) in his New testament glosses claimed that Dionysius probably never wrote anything at all. For him the term 'Aeropagite' denoted a judge (which is very true) and not a theologian and Valla felt wrote that the reference to observing the eclipse of the sun in the "letter to Polycarp" (above quoted) was a blatant fiction. Later in 1504 the well published and scholarly Erasmus published the Valla Annotations along with his biblical works. For this he was criticized by catholic theologians as if it was his own opinion.

By the time of the Reformation, scholars took sides and battle lines drawn. The young Martin Luther favorably studied the CORPUS, as did any young monk. However, in 1519 during the Leipzig Disputation, John Eck used the CORPUS as argument and evidence for the apostolic origin of papal legitimacy. Then, the dispute became a Luther Project. As we know, Luther called the Pope the 'antichrist' and wrote that the best way to destroy the papal hierarchy was to attack the catholic mass and its sacraments. Dionysius in his Ecclesiastical Hierarchy, created a hierarchy of church offices and sacramental rites which correspond to the nine levels of angels presented in the Celestial Hierarchies. This was a most brilliant Platonic expression of the ancient wisdom, 'as above, so below.' Luther in his efforts to condemn and destroy papal legitimacy preferred a later dating for the CORPUS, depriving it of any support of the early apostolic fathers. The PSEUDO dispute was a perfect bootstrap to hang on. He wrote, "I admonish you to shun like the plague that 'Mystical Theology' of Dionysius and similar books that contain such idle talk" and called Dionysius "most pernicious; he Platonizes more than he Christianizes." The real key in this attack lies equally with the reformist protestant mentality against the ancient wisdom and the Platonic Renaissance revival begun by Ficino, Della Mirandola and Cusa, which even a humanist englishman like John Colet, into "Plato himself." Of course, that other polemicist, John Calvin, later grabbed the other bootstrap and railed against the illicit knowledge of god and angels presented in the Celestial Hierarchies. To this day, it is very sad indeed, that the protestants have rejected the Platonic wisdom given forth by Dionysius, the Cistercians and the Renaissance masters, such that there is today, no celestial angelology in their theology, or most importantly, in their prayers..

THE CELESTIAL HIERARCHIES

Four of his writings survived to this day, namely, CONCERNING THE HEAVENLY HIERARCHY; CONCERNING THE DIVINE NAMES; CONCERNING THE ECCLESIASTICAL HIERARCHY; and CONCERNING MYSTICAL THEOLOGY. His most esoteric work, THE CELESTIAL HIERARCHY forms the backbone of the Western Esoteric tradition. In it he names the Celestial Hierarchy as follows:

- | | |
|-----------------------------|------------------------|
| 1. Seraphim | |
| 2. Cherubim | First Triad/Hierarchy |
| 3. Thrones | |
| 4. Dominations (Kyriotetes) | |
| 5. Virtues (Dynamis) | Second Triad/Hierarchy |
| 6. Powers (Exusiai) | |
| 7. Principalities (Archai) | |
| 8. Archangels | Third Triad/Hierarchy |
| 9. Angels | |

(an ancient source comments as follows:)

"The angels are divided into nine choirs and form three hierarchies, hence the "angelic world is presented to our view as a magnificent army ranged in the most admirable order."

"The first hierarchy is composed of the Seraphim, the Cherubim and the Thrones; the second comprises the Dominations, the Virtues and the Powers; the third is formed of the Principalities, the Archangels and the Angels. Each choir has a different office as will be shown in the following outline, necessarily brief, since the scope of this little work does not permit more. But let us fervently beg each one to share with us the particular grace with which it is endowed.

"The Seraphim come first. Their very name means ardor, and they are consumed with the fire of Divine Love of which they are the created representations." This burning love keeps them ever close to God's Throne and they bear love and light to the lesser choirs of angels. O ardent Seraphim, enkindle in our hearts, by the virtue of the Divine Blood, the sacred flame of the love of God with which you are consumed.

"The Cherubim are next. Their name signifies "fullness of knowledge." They are characterized by a deep insight into God's secrets and they truly possess the fullness of the divine science of heaven. They enlighten the lesser choirs of angels and are to them the Voice of Divine Wisdom. O bright Cherubim, instruct us more to appreciate the power of the Precious Blood, in the excellent science of the saints, that we may also praise and glorify God with you.

"The Thrones form the last choir of the first' hierarchy which is the closest to the Divine Majesty. They are so styled because their main characteristics are submission and peace. God rests upon the Thrones and in a certain manner conveys His Spirit by these angels, who in turn communicate it to the inferior angels and to men. We should pray to the Thrones especially for peace. O Blessed Thrones, obtain for us peace through the Divine Blood, that peace which the world cannot give, which comes from submission to God's will in our regard.

"The second hierarchy of angels is more specifically devoted to the management of human affairs. It opens with the Dominations, so called because "they rule over all the angelic orders charged with the execution of the commands of the Great Monarch." Therefore, these bright spirits make known to us the commands of God and their main virtue is

zeal for the maintenance of the King's authority. let vs remember them when seeking God's will and invoke them in our perplexities. O holy angels, pray to God for vs, that we may ever be faithful to His holy will in all the circumstances of our earthly pilgrimage.

"To the choir of Virtues has been confided the duty of carrying out the orders issued by the Dominations. To them is attributed strength and we should seek their assistance in combatting the enemies of our salvation. "it is through them also," says Bovdon, "that God governs the seasons, the visible heavens and the elements in general, although angels of the lower hierarchy have charge of them." Let us therefore have recourse to the Virtues in all extraordinary necessities of mind and body, as well as in times of public afflictions. O mighty Intelligences, help vs always, in virtue of the Divine Blood, to accomplish with perseverance whatever duty has been entrusted to vs by God's will. "The Powers," someone has said, "are the favorites among mortals." They are appointed in a special way to fight against the evil spirits and to defeat their wicked plans. "When we see storms gathering either in the Church or in the State, machinations to resist those who are working for the glory of God, extraordinary conspiracies to defeat some great good which is being planned for some diocese, city or country, then it is that we ought to perform frequent devotions in honor of these Powers of heaven, that they may overturn and destroy all the might and miserable plotting of hell." (Boudon). O invincible Pourers, in virtue of the Divine Blood, defend us against the attacks of the devil, the world and the flesh and make vs victorious against that triple power.

"The Principalities preside over the third hierarchy. Their duties are executive in regard to the visible world of men. They also guard the nations of the earth and St. Thomas says of them: "The execution of the angelic ministrations consists in announcing divine things. Now, in the execution of any action there are beginners and leaders; this-the leadership-belong to the Principalities." We should then invoke them for the protection of our country that it may realize the designs of God upon it. Those who have to exercise any authority should honor these blessed spirits in a special way; they would receive from them graces of light and strength in the discharge of their duties. Sovereign Principalities, in virtue of the Divine Blood, govern also our souls and our bodies, and assist vs in the attainment of our eternal destinies.

"The Archangels are entrusted with the more important missions to men. They are also given as guardians to great personages, such as the Holy Father, Cardinals, Bishops, Rulers of States, and others who have special work to do for the glory of God upon earth. They protect the Church under the leadership of St. Michael and defend it against its enemies. Let us not forget them when praying for the triumph of the Church, that these celestial spirits may safeguard its interests and watch over our Supreme Pontiff. Noble Archangels, we beg you to aid us always, that profiting by the Divine Blood, we may ever live in faith, hope and charity, and die as true children of our Holy Mother the Church.

"The Angels, specially so called, close the last choir of the spirits of light. They are the ordinary messengers sent to men and from their ranks our own guardian angels are usually chosen. They mirror in a very particular way the goodness of God toward vs. They are ever ready to go wherever the will of God sends them, and they minister to all, just and sinner alike. They have a true sense of values and they know that to serve God in any capacity is a very great honor. Let vs frequently invoke their help as they are most happy to be of service to us. As they are our lifelong companions, we shall speak of them more at length later. Most holy Angels be ever for vs the guardians of our safety and salvation, and since we were redeemed by the Divine Blood, obtain for vs the grace of final perseverance."

THE ADAM APOCALYPSE

It would be easy to assume that the angelology of Dionysius derived from St. Paul and thus from the teachings of Christ himself. Of course, we know that St. Paul's conversion at Damascus occurred after the death and resurrection, so Paul had no physical contact with Christ. St. Paul also appears to be the only disciple to specifically mention the names of certain orders of the angels in his writings. So it would seem that the other apostles were not his source. The key to his sources may come from the Essene Community at Qumran.

A recently rediscovered manuscript, one copy in Ethiopian and one in Arabic, entitled THE HEXAMERON containing the ADAM APOCALYPSE, bears the signature of our great Church Father, Epiphanius, Bishop of Cyprus. We know that he was closely connected with early Esoteric Christianity from his church writings which so confuse the scholarly commentators. They are confusing because, like Plato, he carefully weaves the occult truths with exoteric facts, bewildering the historian by leaving between the line occult keys to the inquiring mind. In the ADAM APOCALYPSE, he writes,

"In the beginning, on the first day, God created heaven and the earth, water, air, and fire, the invisible spirits, that is, the angels: the Thrones, the Dominations, the Principalities and Powers, the Cherubim and Seraphim, all castes and orders of spirits."

In addition, the ADAM APOCALYPSE described three orders of angels called heavens comprising ten hosts. The first heaven contains the "beautiful", the Cherubim and the Seraphim, who carry the "throne" of God. In the second

heaven, three more orders dwell, called the dominions (masters) led by Gabriel, the thrones led by Raphael and the sultans, led by Syrial, who blows a trumpet. Between the first and second heaven is a fourth host called the powers and led by St. Michael. In the third heaven three more hosts of angels are described, being the Judges, the archangels and the angels. Above the throne of God floats the Trinity.

This angelology of Epiphanius exactly parallels the celestial hierarchy of Dionysius except for the names of certain angelic hosts. Scholars recognize the ADAM APOCALYPSE as the oldest known source to date of the elaborate ordering of angels, the Arabic version being the oldest text. We know that it was written after the life of St. Paul because it refers to angels blowing trumpets "as described in the vision of John, that is, the Apocalypse"(New Testament). However, to ascribe its authorship to Epiphanius (375 A.D.) is unlikely because he was not an apocalyptic writer. His task was to preserve occult traditions from the censorship and liturgical dogma evolving from the triumph of Nicene Christianity in 325 A.D. As G.R. S. Mead so intuitively observes "Epiphanius knew of an ancient tradition which declared that the Christians originally derived from the Essenes, that Jesus himself had been an Essene and that this Church Father wished to safeguard the doctrinal tradition now stereotyped by the ecumenical decisions at Nicaea."

During early Christianity, the writings of Dionysius were hidden from the profane until the 6th Century and for this reason, modern scholars say that he never wrote the manuscripts that bear his name. (It distresses me to read in a recent book on Angelology that the author says that Dionysius, "pretended to be Dionysius the Areopagite, the first century Greek who was converted by St. Paul at Athens...until around 1450 A.D. he was discovered to be a fraud ...therefore he is now called the pseudo-Areopagite".)The only difference between the ADAM APOCALYPSE and the CELESTIAL HIERARCHY is in the names of certain angelic hosts known as the "beautiful, masters, judges and the sultans". Jewish angelology as reflected in their Quabbalah derived from Chaldean traditions during the Babylonian captivity, adding only Hebrew names to a pre-existing angelic order. About 100 B.C., the Essene Teacher of Righteousness (Jeschu Ben Pandira) merged the Chaldean mystery stream of Zarathustra with the Jewish mystery stream of Melchizedek and Abraham to prepare for the birth event of the two Jesus children. It seems likely that Epiphanius, while using the Chaldean names of his orders of angelic hosts was trying to preserve an esoteric tradition extant in the Essene Community that survived until the destruction of Qumran by the Romans in 68 A.D. Saul the Pharisee, after his conversion and in preparation for his many years of teaching, was instructed by the Essenes to Hellenize the names of the hosts in the celestial hierarchy because the Greek and Roman world were not familiar with the Arabic names of the autocratic state dignitaries. Only after the publication of the Dead Sea Scrolls will scholars connect the Pauline Community with the Essene Community at Qumran. Several authors such as Alan F. Segal, J.A. Fitzmyer, and N.A. Dahl now suspect that St. Paul, especially in the CORINTHIANS, either is directly quoting or otherwise relying on scrolls received from Qumran.

THE CHALDEAN PLANETARY SPHERES

Against this background of the Christian Church Fathers commenting on the angelic hierarchy, there remained over the so-called pagan authors commenting on the planetary hierarchy as revealed through the ancient mysteries. The rise of Christianity was inversely proportional to the demise of the ancient mysteries. The Emperor Julian the Apostate was initiated into the Mithraic Mysteries and after his death, there was no longer any trace of the ancient mysteries in either the Roman Rulers nor Christian clergy. In 399 A.D. the Emperor Theodosius issued his famous edict abolishing the mysteries,

"Whatever privileges were conceded by the ancient laws to the priests, ministers, prefects, hierophants of sacred things, or by whatsoever name they may be designated, are to be abolished henceforth, and let them not think that they are protected by a granted privilege when their religious confession is known to have been condemned by law." The early Christians destroyed the temples, burnt the libraries and broke the statues and relics of the Ancient Gods. The bearers of the occult mystery wisdom of Osiris, Mithras Serapis, Demeter, Appolo, Dionysius, and Mani went underground not to resurface until the 17th Century with the publications of the Rosicrucian manifestos and the 18th Century Masonic rituals.

Simultaneously, the exoteric scientific wisdom of the Greeks steamed into the Academy of Edessa in Syria. This school was the last vestige of the arts, music, logic, math, geometry, medicine and other Liberal Arts of Plato and Aristotle. In 489 A.D. the Emperor Zeno closed this school and drove out all its students and teachers. With the arts and sciences of Hellenistic wisdom finally closed to the West by the Roman Emperors and Western Christian Church, the center of the ancient wisdom transformed to the Persian Academy of Jundi Sabur. Henceforth, the advancement of the arts, sciences and medicine was the dominion of the Arabic culture.

The first and greatest exposition of the planetary hierarchy was a long poem by Martianus Cappella entitled, DE NUPTIIS PHILOLOGIAE et. seq. It was written about 500 A.D. in North Africa and was widely distributed and recognized as an occult textbook late into the 19th. century. It forms the cosmology later revived by the great Arab

scholar, Avicenna and like the CHEMICAL NUPTIALS of Christian Rosencrutz is the allegorical story of a marriage performed in heaven.

Cappella tells of the courtship of Mercury and Philologia that travels up through the planetary spheres to the castle of Zeus, where their wedding takes place. During the journey, the Gods of the planets are identified. The planetary spheres are moved by the Muses emitting the sounds of "Music of the Spheres". Also, the intervals between the planetary spheres are correlated with the Pythagorean musical intervals of the seven tone scale. All is harmony of music and number in the classic Pythagorean sense. The Gods and their spheres were:

Urania Fixed Stars (Zodiac)
Polyhymnia Saturn
Euterpe Jupiter
Erato Mars
Melpomene Sun
Terpsichore Venus
Calliope Mercury (Cyllenium)
Clio Moon
Thalia Earth

As we shall develop later, this ninefold planetary hierarchy will correspond to the ninefold angelic hierarchy of Dionysius. It represents the ancient seven Chaldean planets with the addition of earth at the bottom and the sphere of the zodiac at the top. The doctrine of the Ascent of the soul through seven successive stages of being or consciousness originates with the Babylonian myth of Tammuz and Ishtar and is memorialized in the seven steps of the Ziggurat. Later, this doctrine appears in the POIMANDRES of Hermes, the royal arches of Enoch, the seven heavens of St. John's REVELATION and Mohammed's NIGHT JOURNEY TO HEAVEN with the angel Gabriel. After the birth of Christ, we see the doctrine of the planetary spheres accepted by the Christian Gnostics at the School of Alexandria. The Demiurge of Saturn gave birth out of himself to six sons or aeons, who together became the seven planetary spirits of the created material world. They are as described by Origen,

Ialdabaoth----- Saturn
Iao----- - Jupiter
Sabaoth----- Mars
Adonaios----- Sun
Astaphaios----- Venus
Ailoaios ----- Mercury
Oraios ----- Moon

Unfortunately, the treasures of Gnostic wisdom, bearing a mixture of the Christos and Greek Platonics have not survived since the destruction of the great library of Seraphium once by Emperor Theodosius and his crazed Christians and late again Caliph Omar in 641 A.D. to preserve the dominance of the Academy at Jundi Sabur.

THREE CULTURAL STREAMS

In retrospect, the transition from paganism to Western Christianity took place over a remarkably short period of time. This push came as the result of at least three very strong impulses. On the one side there was the impulse of exoteric Christianity which Steiner says came from the time spirit or Archaic of the Greek nation. This Archaic could have ascended to the rank of Spirit of Form or Power, but instead, he sacrificed himself and became the missionary, the inspirer of out-spreading exoteric Christianity. Through his efforts the religion of Christianity spread throughout Europe and He became the inspirer for the Gothic Cathedrals, Byzantine and Romanesque art. In addition, the several folk-spirits of Europe became the servants of this Christ Spirit and because of this, they worked in various ways in the many different cultures instead of in a unified way in one particular culture.

This exoteric spirit of Christianity worked behind the scenes and with Him, it may be said, so did the bodies of the Christ. This remarkable fact was explained by Steiner in The Principle of Spiritual Economy (1909). "When Christ left the material world, innumerable copies of His etheric and astral bodies were preserved and came into being. These were destined to be woven into the bodies of human beings suited to disseminate Christianity." Over the course of time, certain persons, regardless of nationality, who were mature and suitable enough, had these copies of the etheric and astral bodies engrafted into their souls.

This process has a correspondence to distinct periods in the development of Christianity. For example, the etheric body being the bearer of memory, effected the early church fathers such as St. Irenaeus, Papias and St. Augustine with emphasis on memory of and a direct physical teaching of the Christ event. Missionaries who also received a copy of the etheric body of Christ, such as Columban, Gallus and St. Patrick, taught memory of the physical event

and the rules and covenants of the new Christian order. This period of the spread of the etheric body of Christ ended about the 9th Century with John Scotus Erigena.

Beginning the 10th Century, the copies of the astral body of Christ began to circulate in the leading Christian personalities of Europe. Being the seat of the emotions, these copies of the astral body caused great emotional sentiments, fervor and zeal, and a direct feeling of the Christ. This exalted devotion was evident in such persons as St. Francis of Assisi and Elisabeth of Thuringen and also in the German mystics, Meister Eckhart and Johannes Tauler. The thinking function of the astral body of Christ produced the great teachers of scholasticism, Albert the Great, St. Thomas Aquinas and Cardinal Nicholas of Cusa. They implanted into traditional Christian dogma, the capacity to think with analytical penetrating logic derived from Aristotle.

This evolution of Christianity corresponding with the etheric and astral bodies of Christ, through the process of spiritual economy, came to an end in the 15th Century. With the onset of the Fifth Cultural Epoch, mankind required individual reliance and development of the personal ego. These greatly inspired personalities of early Christianity and the Middle Ages are a tribute to the past and a rarity of the present.

THE PERSIAN ACADEMY

As a polar opposite to the ubiquitous stream of exoteric Christianity, a second influence arose in Persia that was called by Steiner the "culture of 666 A.D." (How Do I Find the Christ, 1918). Briefly stated, the fourth cultural epoch occurred from 747 B.C. to 1413 A.D., being the astrological cycle of Aries lasting 2160 years. The mid-point of this epoch (-747 plus 1080) was reached in the year 333 A.D. "The mystery of Golgotha preceded the middle point of this epoch by 333 years, i.e. by just as many years prior to this point, as years after it, certain spiritual powers intended to direct the evolution of mankind into quite different channels from those into it was ultimately lead by the mystery of Golgotha". Thus, 333 years after this midpoint is the year 666 A.D., the same year as the number of the beast (Sorath) in the APOCALYPSE of St. John. The intention of these spiritual powers was to instill in exoteric Western Christianity a Hellenistic-Gnostic inspired natural science that would cut off mankind's spiritual path to achieve Manas, Buddhi and Atma in future cultural epochs.

The time for the endowment upon humanity of what Steiner calls the consciousness soul was destined for the Fifth Cultural epoch (age of Pisces) beginning in 1413. Without firmly grounding humanity in the Christ impulse of exoteric Christianity, the human ego would not be free at this later epoch to develop as intended by the Spirits of Form.

This neo-Persian influence was centered in the Academy of Gondhishapur (Jundi Sabor) and it reached its peak in the year 666 A.D. Steiner says that all the teachers within the Academy were inspired by Luciferic-Ahrimanic spiritual powers whose purpose was to instill pre-maturally into mankind the consciousness soul inspired by the Hellenistic sciences. As discussed above, the fruit of Greek wisdom in the sciences and medicine were not Christ inspired because the Archai of the Greek nation sacrificed himself to become the impulse of Exoteric Christianity. Thus, the great intellectual achievements of this leading spirit of the Greek culture were turned back against him by the impulse of the Persian Academy.

Beginning in the 12th Century, the scholarly sciences of the Arabs were translated into Latin and carried to the West. Until the rise of the Florentine Academy in the 15th Century, all Greek texts available to Western scholars came from Arabic sources. Thus, the entire natural sciences and particularly medicine came to the Western universities in an Arabic form influenced by the powers of Lucifer-Arihiman. As a response to this powerful influence, in the 13th Century Albert Magnus and St. Thomas Aquinas in Paris began teaching the logic and natural science of Aristotle in a new form saturated with the Christian dogma of the classic Church Fathers, the likes of St. Augustine, Dionysius, St. Jerome, St. Clement, Origen, Eusebius, and Tertullian. The scholastics waged intellectual war upon great Arab philosophers and physicians Avicenna, Averroes and Moses Maimonides. Scholasticism was the burning torch of Western Exoteric Christianity in the otherwise dark Middle Ages waiting for the dawn of the consciousness soul in the Fifth Cultural Epoch commencing the year 1413.

In fact, the tide did turn. In 1439, the stranger named Gemistos Plethon silently arrived at the court of Cosimo de Medici with original Greek texts of Plato and various neo-Platonic authors. In addition he had preserved major Hermetic texts and the Kabbalah. When Marsilio Ficino was commissioned to translate these original texts, the Arabic sources were bypassed and thence began the Renaissance and the emergence of the consciousness soul.

ESOTERIC CHRISTIANITY

The third influence at work in Europe during the Fourth Cultural Epoch was the special mission of Esoteric Christianity beginning with Dionysius at the School of St. Paul at Athens.

Steiner says in the GOSPEL OF ST. JOHN,

"This esoteric Christianity has always been fostered alongside the outer Christian exoteric teaching...(ST.) Paul founded an Esoteric school. the director of which was Dionysius, the Areopagite, mentioned in the acts of the

Apostles. In this Christian esoteric school at Athens which was directly founded by Paul himself, the purest Spiritual Science was taught."

Steiner further corresponds that in the same way the Archai of the Greek nation sacrificed himself to become the impulse of exoteric Christianity, the Archangel of the Celtic peoples sacrificed Himself to become the inspiring spirit of Esoteric Christianity. This particular folk spirit upon completing his mission as an archangel had the opportunity to rise to the level of an Archai or Spirit of the Age. However, he renounced, he remained behind so as to become the servant of the various Archai that would arise in the future Europe. And no matter how the various Archai would work, no matter their particular task, the guiding spirit of Esoteric Christianity would remain a source and inspirer of the ancient wisdom surviving in the various mystery centers.

It goes without saying that the streams of Esoteric Christianity are intentionally hidden. B.C.J. Lievegoed in his book, *Mystery Streams in Europe* (1982) identified four major currents which he describes in a general overview: WESTERN, originating in the mysteries of ancient Atlantis, trailing through Hibernia and Celtic Christianity, known as the King Arthur Stream, which purpose was to develop the Buddhi impulse.

EASTERN, originating in the five Post-Atlantis fifth sub- races, known as the Grail Stream, transplanted by Joseph of Arimathea from Judea to Glastonbury, which purpose was to develop the Manas impulse.

In 869 A.D., the East-West impulses united together with the deed of Parsifal, who as a knight of King Arthur, became King of the Grail.

NORTHERN, originating in the very ancient mysteries of Hyperborea, trailing through the Germanic and Scandinavian Drotten and Trudi mysteries, known as the Vidar Stream, which purpose was to develop the ego impulse.

SOUTHERN, originating in the ancient mysteries of Lemuria, trailing through the Egyptian- Hebraic mysteries, Hermetic, King Solomon and Templar mysteries later known as the Rosicrucian Stream, which purpose was to develop the Atma impulse.

With the coming of the Michael Age in 1879 and the end of the Kali Yuga in 1898, all four esoteric streams came to an end. In 1923 a new mystery center was chosen and now all four impulses work towards a unity in the new mysteries.

A most unique feature of the efforts of these two spirits of Exoteric and Esoteric Christianity is that they do not seem to work together. In fact, the Exoteric spirit works against the Esoteric impulse to the point of death and extinction. Consider this. During the Albigensian Crusade, ordered by Pope Innocent III, (1208), the troops of military leader Simon de Montfort swept through southern France with a vengeance. At Bram, he took a hundred hostages, cut off their noses and upper lips and blinded all but one who led a procession to the castle. At Lavaur, ninety captured knights were ordered hung, then impatiently, they were stabbed to death. Inside this castle, 400 Cathars were found and burned alive. At Minerve, the entire captured army as well as all the Cathar parfaits, were burned alive on a flaming pyre. After the death of Pope Innocent, Pope Gregory IX ordered the Dominicans to expunge the remaining Cathar sanctuaries. Over the next fifty years, the Inquisition burned perhaps 5,000 heretics, sometimes exhuming the bodies and publicly burning the bones of those lucky enough to have escaped the funeral pyre the first time.

Among the lost treasures of the Cathars is believed to be the Holy Grail of Esoteric Christianity. During the siege of the mountain top castle of Montsegur four monks slipped out at night, lowered themselves on rope down the rock cliffs and made their getaway to the caves at Sabarthes. The next day, March 16, 1244, the Inquisition marched 200 Cathar monks out of the captured castle and burned them alive.

This particular episode of extinction by the Popes and Dominican Inquisition lasted over 113 years. Beginning with the razing of the Essene Monastery at Qumran in 68 A.D. by the Romans, through the death by burning of Jacques De Molay on March 14, 1314 at the Cathedral of Notre Dame, we see the great efforts of Esoteric Christianity martyred at the stake by the leading personalities of Exoteric Christianity. Of course, this veil covering the historical forms of Exoteric Christianity has been penetrated by the evil of Lucifer-Ahriman which even this great spirit cannot escape.

TRACES IN MEDIEVAL ART

Although the Great God Pan is dead, he rules us from the grave. Throughout early Christianity, there is one remarkable truth, the icons of pagan art are transformed into Christian symbols. The sites of pagan temple sacrifice are transformed into Christian Churches and the occult wisdom of the mysteries is preserved in the stream of Esoteric Christianity. Consider that the Basilica of St. Peters Church in Rome was the site of a temple dedicated to Mithras. The Cathedral at Chartres was the site of an Hibernian mystery center and later a Druid cave sanctuary containing the Black Madonna. The Abbey at Glastonbury, England was also an ancient site of an Hibernian mystery center before St. Joseph of Arimathea received his charter and twelve hides from the Pagan King Arviragus.

There is not a better example of how pagan idols were transformed into Christian symbols than the two stone slabs on the walls of the Visigoth Church (7th. century) at Burgos, Spain. As shown, above is the bust of "sol" supported by winged angels. Below, the sun is replaced by a bust of Christ holding a cross.



Prior to the 10th Century, the most elaborate paintings occur as the triumphal arches in Santa Marie Antiqua and San Prassede in Rome. At Santa Marie Antiqua, different hierarchies of angels are designated to different spheres with different colors used to distinguish the groups. The Seraphim have white robes, red and amber wings and their feet are set in flames. The archangels wear red robes. The Cherubim support the throne of God. Remarkably, there are day and night angels colored pink and green respectively.

On the apse of San Prassede, the Virgin Mary is seated in glory on a throne. To each side of her, are groups of angels with wings, halos on their heads, and folded hands in adoration. Above her head is the symbol,

A 12th Century Fresco in the Chiesa di San Pietro at Civate shows the angelic orders of virtues, principatus and potestates with wings and halos.

A 12th Century tympanon on the south portal at Moissac entitled, "The Lord in Glory" shows Christ on a throne surrounded by the twenty-four elders, two angels and the four beasts of St. John's APOCALYPSE. As the four beasts of Ezekiel's vision, the lion, bull, eagle and man usually are identified with the Cherubim order and appear frequently in Medieval Art and sculpture. Likewise, the twenty-four elders of the APOCALYPSE appear throughout Europe in such places as on the Portico de la Gloria at Santiago, Oloron-Sainte-Marie in Carboeiro, three times at the Cathedral at Chartres and at Notre Dame in Paris. In Northern France alone, there are Romanesque sculptures of the Elders in at least nineteen different churches.

Another source of angelology survives in the twenty-seven manuscripts of Beatus, a bishop of Libera, Spain who wrote a commentary on St. John's APOCALYPSE. He includes all symbols of esoteric Christianity particularly the sacrificial lamb of Christ pierced by the sword in the form of the cross. The four beasts are shown either as the Evangelists or as Cherubim angels with six wings. The seven spirits are shown as angels with two wings. The twenty-four elders wear crowns and are displayed as kings in adoration. Throughout the manuscripts, there appear wheels, probably from Ezekiel's vision, bearing a motif of Ying-Yang symmetry.

A very clear example of the angelic orders appears in the Assunta by Masolino. Here, the Virgin Mary is seated in an oval mandola surrounded by Cherubim and Seraphim. They are shaped like swallows with human heads and halos. Outside this oval is another layer of angels holding emblems of their particular orders, such as virtues and shields, orbs, lancers and scepters and a banner inscribed-Virtues.

Likewise, the orders are clearly laid out in an illumination of a 14th Century copy of the Dionysius manuscript at the Bibliotheque Nationale. St. Denis is shown at his desk writing his book of commentary entitled DE HIERARCHIA. Above him in nine arcs are shown the nine Angelic orders of Dionysius with angels with wings and halos. This particular representation contains the core of Esoteric Christianity replete with figures of the most Holy Trinity above the nine orders. A similar woodcut version is by Franchino Gafori (1508) with the Muses on the left and the chaldean planets on the right and the earth on the bottom center with the 4 ancient elements.

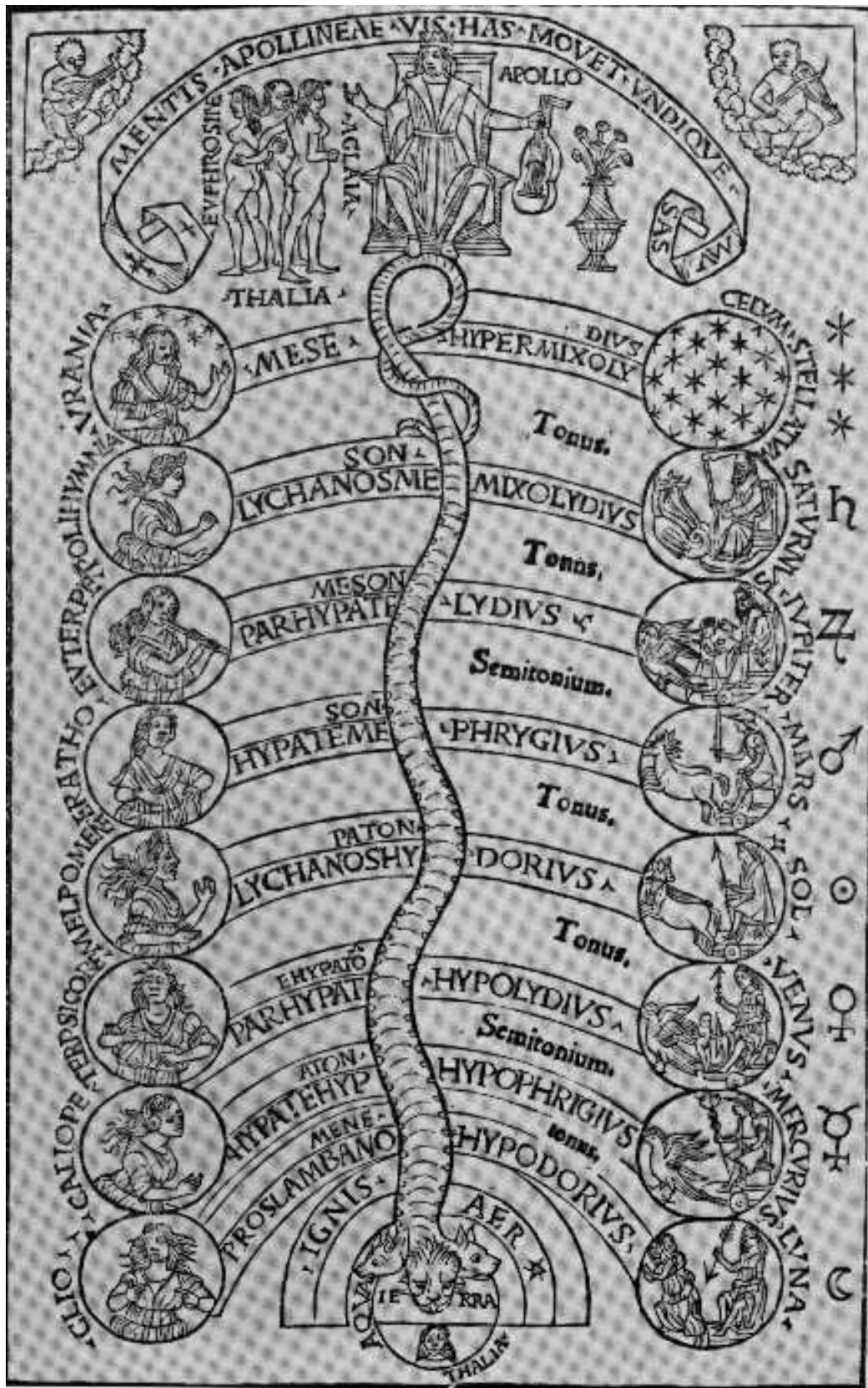

Most representations of the angelic order are less demonstrative than that of St. Denis. Typically, the orders are recognized by a secret script of symbols and colors. For example, in the painting *Mary, Queen of Heaven* by Frans Hals, we see the Virgin surrounded by various orders of angels, each order being represented by various types of musical instruments while still preserving the esoteric characters of the Holy Trinity placed above the angel groups. This symbolism seen in sculptures, paintings and illuminations throughout the Middle Age has been collected by Kathi Meyer-Baer in her book, *MUSIC OF THE SPHERES AND THE DANCE OF DEATH* (1970). She described the correspondences drawn from the historical commentaries as follows:

Angels with six wings, the Counsellors:

Seraphim	Flames	Love
Cherubim	Eyes	Knowledge
Thrones	Wheels	Devotion

Angels with four wings, the Rulers:

Dominations	Royal insignia	Nobility
Virtues	Scale	Calmness
Powers	Arms	Activity

Angels with two wings, the Servants:

Principalities	Scepter	Law
Archangels	Crozier	Work
Angels	censer	Prayer

In addition, we also find a variety of shields, orbs, crowns, lances and numerous musical instruments including harps, lutes, flutes, trumpets, fiddles and organs.

In the 16th Century, we also see an interesting musical score written by Robert Wilkinson entitled *Salve Regina*. It was written in nine parts with each part designated to one of the nine orders of the Celestial Hierarchy. The voices and the orders were:

Quadruplex-----	Seraphim
Triplex -----	Cherubim
Primus Contratenor -----	Dominations
Tenor -----	Potestates
Primus Bassus -----	Angeli
Medius -----	Thrones
Secundus Contratenor-----	Principalities
Inferior Contratenor -----	Virtues
Secundus Bassus -----	Archangeli
ST. THOMAS AQUINAS	

Prior to St. Thomas Aquinas, the most comprehensive commentary on the CELESTIAL HIERARCHY of Dionysius was by John Erigena Scotus in the Ninth Century. St. Thomas was born near Naples in the ancestral castle of the Courts of Aquino about year 1224. He studied the Liberal Arts at the University of Naples and at this time met Dominicans who had opened there a school of theology. Against the desires of his family, he became a Dominican and travelled to Paris to study theology from Albert the Great. Still upset, his widowed mother sent two of his brothers from the army to capture and hold him hostage. After more than a year in captivity, the Dominicans had him set free after pleading with both the Pope and the Emperor. St. Thomas became the prized pupil of Albert, called the Magus, because of his wisdom of the Hermetic sciences as well as being the foremost Western authority of the Hellenistic arts and sciences of Aristotle.

In 1256 he received his doctorate in theology and began his long career of teaching and writing only after receiving a papal dispensation because he was so young. After several years in Paris, he returned to Italy. His fame as a scholar, teacher and writer became so great, he turned down offers to become Archbishop and Abbott, so as to continue his vocation. He continued the tradition of Albert the Great to incorporate the works of Aristotle into theology. To accomplish this, he translated his own texts directly from the Greek because he felt the Arabic versions to be corrupted.

His greatest achievement and, of course, the source book of medieval scholasticism was the unfinished *SUMMA THEOLOGICA*. This text consists of thousands of pages of pinhead dialectic on such subjects as the nature of God, the Trinity, the Angels, Creation, Man, and Divine Government. While saying Mass on December 6, 1273, he had a revelation, after which he never wrote again. When urged to complete the *SUMMA*, he is said to have responded, "I can do no more, such things have been revealed to me that all I have written seems as straw, and I now await the end of my life." He died several months later while on journey to a church council at Lyons.

In the *SUMMA*, his discussion of the angelic degrees of hierarchies and orders covers eight points of inquiry:

1. Whether all the angels belong to one hierarchy?
2. Whether in one hierarchy there is only one order?
3. Whether in one order there are many angels?
4. Whether the distinction of hierarchies and order is natural?
5. Of the names and properties of each order.
6. Of the comparison of the orders to one another.
7. Whether the orders will outlast the Day of Judgment?
8. Whether men are taken up into the angelic orders?

Through the hundred of references to the CELESTIAL HIERARCHY, we come to know the contents of this work in the same way we learn about the lost writings of Origen through the commentaries of the Church Fathers.

St. Thomas first establishes a distinction between the human and angelic hierarchy. Although all men are of one species and have one natural mode of understanding, the angels have three distinct and separate hierarchies based upon the more universal knowledge of truth by the superior angels. In addition, the diversity of order arises from the diversity of offices and action, which is reduced to three, namely, the summit, the middle and the base. Likewise, within each order, there are angels who are first, middle and last.

Next, St. Thomas endeavors to clean up messy terminology that arises from less than perfect commentaries. The second hierarchy of Dionysius included Dominations, Virtues and Powers. However, Pope Gregory the Great (6th Century) says Dominations, Principalities, Powers, then for the third hierarchy, Virtues, Archangels and Angels. Both draw upon St. Paul on their authority. In Ephesians (I. 20-21) he says, "God has set the man Christ on his right hand in the heavenly places above all principality and power, and virtue and dominion." However, in COLOSSIANS (I. 16) he says, "Whether Thrones, or Dominations or Principalities, or Powers, all things were created by Him and in Him."

Apparently, this conflict between Dionysius and Gregory was important to resolve because it consumes the largest portion of the text. St. Thomas regards the second hierarchy as a government or administration of execution of divine tasks. To the Dominations belong the job of appointing what things are to be done. To the Virtues belong the jobs of carrying out what is to be done. To the Powers belong the orders to be commanded what has been decreed by the higher orders. Citing Dionysius, he says that the proper name of each order expresses its property. For the first hierarchy, the Cherubim have the excellence of knowledge and the Seraphim the excellence of ardor and charity. Both enjoy having an immediate knowledge of the Divine will and plan. The Thrones are recognized as material seats, raised above the earth and because of their shape, are open to receive the sitter and to serve Him. To the third hierarchy lies the execution of the divine plan. The Principalities are the leaders of angelic ministrations. The angels are the messengers who simply execute what is to be done. Between the two, are the Archangels or angel princes who announce the tasks to the angels but answer to their higher order of Principalities. To each man a guardian angel is assigned for life.

Without resolving the issue, St. Thomas suggests that both orders of Gregory and Dionysius are reasonable because little or no difference exists in reality between the orders from mankind's point of view.

In an interesting digression St. Thomas addresses the issue of whether men are taken up with the angelic orders. He answers that Christ promised (Luke 20) the children of the resurrection will be equal to the number of the angels in heaven. By the gift of grace men can merit glory in such a degree as to be equal to the angels in each of the angelic orders and this implies that men are taken up into the orders of the angels.

This concept was further elaborated by Steiner when discussing the Eastern tradition of Buddahood. A Dhyani-Buddha is ensouled by a spirit of the Principalities down to his physical body. A Bodhisattva is ensouled by an archangel down to his physical and etheric bodies and a human Buddha is ensouled by an angel down to his physical, etheric and astral bodies.

Finally, St. Thomas addresses some issues concerning the evil angels or demons. He reasoned that since the angels in God's administration existed in certain well defined orders, so should those spirits who work against the divine plan. For this he cites the wisdom of St. Paul (Ephesians), "our wrestling is not against the flesh and the blood but against Principalities and Powers, against the rulers of the world of this darkness against the spirits of wickedness in the high places". The order of Powers is that of the Spirits of Form. It was during the Lemurian epoch that Lucifer and his legions invaded the astral body of mankind to work in opposition to the Divine Plan of the spirits of Form. Similarly, during the Atlantean epoch, the spirits of Ahriman or Satan (as called by the Scholastics) invaded the etheric body of mankind in opposition to the Divine Plan of the Principalities or Archai.

Although St. Thomas goes to length in his discussions about angels and demons, he ends his treatise on the hierarchies of Dionysius rather abruptly. One would certainly wish his divine inspiration to extend further than his treatise on "Irascible passions" or the " Goodness and Malice of the Interior Act of the Will". Mankind had to wait to the revelations of the Michael Age for the next chapter.

THE MARRIAGE IN HEAVEN

The marriage of the ancient Chaldean planets to the angelic hierarchy of Dionysius takes place through the medium of music. In the 6th Century DE NUPTIIS of Martianus Capella, we saw the Chaldean planetary spheres moved by the Muses. In the evolution of angelology through the Middle Ages, it was only a small leap of faith to replace the Hellenistic Muses with the Celestial Hierarchy of Dionysius.

During this transition, a remarkable woodcut by Franchino Gaffori (1508) stands out. As shown, there is a correspondence between the Chaldean planets on the right, the Muses on the left and the tones and intervals of the Pythagorean musical scale in the middle. At the bottom is planet Earth represented as the center of this cosmos, surrounded by the four ancient elements. At the top is Apollo, the sun god, treading on the three headed serpent. The entire scheme represents the Hellenistic cosmos of Plato and Pythagoras with Christian symbols. The transition from Greek Paganism to Esoteric Christianity is accomplished with the simple substitutions of Apollo into Christ, the sun spirit treading the serpent Satan and the Muses into the angelic hierarchy of Dionysius.

Robert FLUDD was born in 1574 and bred a true Elizabethan, his father having received knighthood. He graduated from St. John's College, Oxford with a Master's degree in 1598. Thereafter, he travelled for six years in Europe supporting himself as a tutor in wealthy families. On his return to England he entered Christ Church, Oxford and graduated in 1605 with a Doctorate of Medicine. However, it took him four more years to be accepted in the College of Physicians because of his rejection of traditional medicine as practiced in Calvinist and Anglican England. As a private physician he followed the practice of Paracelsus and homoeopathy, with a healthy dose of astrology, magnetic healing and alchemy. For each patient, he calculated their horoscope and determined their critical days from planetary transits.

Around the year 1614, we see the publication of the three Rosicrucian Manifestoes and although, he always denied being a Rosicrucian, he spent great efforts in publishing defenses to the secret society. His many textbooks on the ancient wisdom and esoteric Christianity were published in folio format, replete with more diagrams and illustrations than occultists have seen before or after. A true Renaissance man, his goal was none other than a complete encyclopedic tabulation of the esoteric sciences.

In his treatise, HISTORY OF THE MACROCOSM, he discusses and accepts the cosmology of Martianus Capella. With Fludd the marriage of Capella and Dionysius is complete. In dozens of illustrations, he unites the Chaldean planets and the angelic hierarchy (with the Pope Gregory reversal) as follows:

1. Moon ----- Angels
2. Mercury----- Archangels
3. Venus----- Virtues
4. Sun----- Principatus
5. Mars ----- Potestates
6. Jupiter-----Dominations
7. Saturn----- Throni
8. Fixed Stars (Zodiac)----- Cherubim
9. Primum Mobile----- Seraphim

The Holy Trinity

Henry Cornelius Agrippa (his portrait) of Nettesheim revived an ancient wisdom that had been completely lost from the time of the Magi and King Solomon. In his tables of the planets he assigned to each of the Chaldean spheres, an intelligence, which by nature is good. He also assigned to each a spirit, or demon which by nature was evil, to the extent that the demon worked against the plan of the intelligence. Thus, for each of the angelic hierarchies associated with a particular planet, there were named presiding spirits. Naming spirits was important for the ancient practice of Geomancy and inscribing talismans.

For example, look at the planetary table of MERCURY.

The Table of Mercury in Hebrew Note

ק	ח	ט	ה	ד	ס	צ	א
8	58	59	5	4	62	63	1
מט	יה	יר	נב	נו	יא	י	נו
42	15	14	52	53	11	10	56
מא	כג	בב	מד	מה	יש	יה	מח
41	23	22	44	45	19	18	48
לב	לד	לה	כט	כה	לח	לט	כה
32	34	35	39	38	38	39	25
מ	כו	כז	לז	לו	למ	לנ	לג
40	36	37	37	36	30	31	33
יו	מז	מו	כ	כא	תג	מב	כד
17	47	46	30	21	43	42	34
ט	נה	נר	יב	יג	נא	נ	יו
9	55	54	13	13	51	50	16
סד	כ	ג	סא	ס	י	ז	נז
64	2	3	61	60	6	7	57

Signacula sive Characteres

Mercurij

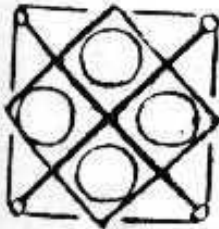

Intelligentia Mercurij



Demonij Mercurij

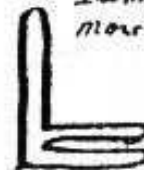

First the kamea or magic square has 64 squares, eight on each side. The numbers vertically, horizontally and diagonally all add up to the number 260 and the sum of all is 2080. The intelligence of the planet is Tiri-el and the demon is Taphthartharath. To prepare a talisman for good or evil purposes, a sigil of the spirit is drawn. First, the name of the saint is reduced by AIQ-BEKER or "the Quabbalah of Nine Chambers." Thus, for the demon of Mercury, the GEMATRIA (courtesy of Doug Evans, the Hermit) for the seven Hebrew letters is Tau, 400; PeH, 80; Tau 400; Resh 200; Tau 400; Resh 200; and Tau 400. This reduces to 40,8,40,20,40,20, and 40. Second, beginning with a small circle, a continuous line is traced upon the Kamea to each of the reduced numbers. The resulting figure shown at the lower right corner, (resembling an upside down F) is the sigil symbol to be traced on the talisman for evil purposes.

Likewise, the seal of the planet is a symmetrical design arranged that its lines pass through every number on the Kamea, thus, becoming a sort of synthesis of the magic square.

The obvious purpose of such signs, seals, and sigils was for invoking spirits, both of a good and evil nature. Agrippa doubtless drew upon the Lemegeton or Lesser Key of Solomon and the Book of Enoch Angelic tables for his sources. Later ceremonial magicians such as Dr. Rudd, Dr. John Dee, Sir Edward Kelly and Casaubon drew upon Agrippa's text, *De Occulta Philosophia* (1651) and Rosicrucian centers existent in Central Europe. By the late 19th

Century these planetary tables were again lost, until McGregor Mathers translated the Key of Solomon and revived "the Treatises of Dr. Rudd" from manuscripts in the British Museum to be used for ceremonial rituals in the Golden Dawn. Even Steiner in *The Apocalypse of St. John* (1908) performs the gematria of the evil spirit of the sun-SORATH as Tau 400; Resh 200; Van 6 and Samech 60 for a total of 666, the number of the beast! He also draws the sigil for the sun demon as "a thick stroke bent back upon itself and terminating in two curved points".

The important theme here is not the invoking rituals of ceremonial magicians but the recognition by medieval occultists of the practice of the ancient wisdom of naming planets and stars for the spirits (whether good or evil) who rule and preside over them. Central to the angelology of Agrippa naming the intelligence and demon of each Chaldean planet was the esoteric understanding that mankind was the intelligence spirit of planet Earth. Occultists like Agrippa knew that mankind received a task from the Elohim to evolve into a ruling planetary spirit, both as a mover of the planet around the sun and as bearer of creative forces in earth kingdoms of mineral, plant and animal. By assigning the planetary intelligence of earth to mankind, Agrippa placed the earth in the order of the Chaldean planets and mankind in the order of the angelic creative hierarchies.

THE ROSICRUCIAN ENIGMA

During this time we also see the transition from the earth centered cosmos of Ptolemy to the sun centered cosmos of Copernicus. The transition was however, a spiritual one, for the earth centered scheme was a spiritual representation of ruling orders of the angelic hierarchy. The ancient wisdom surely knew the astronomical fact that the sun was the center of our planetary system. Exoteric sources include Aristarchus (260 B.C.) who laid the foundation for the remarkable achievements of Archimedes and Hipparchus. The Ptolemaic scheme was an effort by Esoteric Christianity to preserve a spiritual fact that earth and mankind were the center of the Celestial Hierarchy.

In all of the ancient religions, one never sees the planet earth represented as one of the seven Chaldean planets.

Likewise, when spiritual beings and intelligences are assigned to the various ancient planets, as we saw supra with Origen and Agrippa, no spirit is assigned to the Earth. This was because esoterically, mankind itself was considered the bearer of the intelligence of this planet.

Looking at the Celestial Hierarchy of Dionysius, we see the first hierarchy with three orders of spirits, the second hierarchy with three orders of spirits and also the third hierarchy with three orders of spirits. If one wished to place mankind in the Celestial hierarchy, he would be the Fourth Hierarchy, with a potential three orders or graduations of humans.

Mankind as a creative Fourth Hierarchy was certainly the intention and grand plan of the Elohim or sun spirits of Form. However, after the fall, mankind united himself too strongly with the earth and lost his relationship with the creative sun spirits. Instead of being the lowest rung on the chain of the creative angelic hierarchies, mankind was in place and stead the highest of the kingdoms of nature. The earth gave forth the mineral, plant, animal and human kingdoms.

This was the major theological problem addressed by the Scholastics of the Middle Ages and the Rosicrucians, as represented by Flood, in the 16th and 17 Centuries. It was also the crux of the spiritual problem between the Copernican and Ptolemaic universes. In the course of evolution of our solar system, the earth separated out of the mass of the sun as a separate and distinct planet. Christ, as leader of the Spirits of Form (Powers) remained behind on the sun to guide the evolution of the earth, from outside the earth through His agency of the Elohim Spirits of Form. Because of the Fall, mankind had to be redeemed by Christ, a spirit from the sun. In this way, the evolution of the earth united with the evolution of the sun. At his death on the cross, Christ became united with the earth and as such became the planetary spirit of the earth. Before the fall, it was the plan of the Elohim, that mankind become the planetary spirit of the earth. Thus, mankind's task to become the Fourth Creative Hierarchy had to be abandoned as Christ took over this mission to fulfill the allotted task of the earth as it raised its kingdoms of nature.

In a very real sense, the Ptolemaic system with the earth as the center of the planetary system and mankind as the Fourth Hierarchy was the ordained plan of the Elohim. However, when Christ descended through the spheres, incarnated on earth and died on the cross to redeem our sins, mankind's relationship to the planetary system significantly changed. This "cosmic mistake" brought about by the fall and human sin is represented in the Copernican system with the sun as the center and prime mover of the planetary affairs. The realization of this cosmic change of plan of the Elohim was the heart and soul of the medieval Christian and profoundly effected the thinking of Esoteric Christianity.

Nicolaus Koppernigk was born in the year 1473. Dr. Steiner (as well as the Good Madame Blavatsky) says that the astral body of former Cardinal Nicholas of Cusa (1401-1464) (a page from his book) was woven into the astral body of Copernicus, thereby preserving his scientific wisdom. A certain spiritual thread is visible in these two personalities preparing the world for the dawn of scientific materialism. Nicholas of Cusa was a precursor of Copernicus in that his observations in astronomy led him to believe that the earth was a moving body and not the fixed center of the cosmos according to the Ptolemaic view. In addition, this scientific Nicholas was very learned in

the orders of the celestial hierarchies through the writings of John Scotus Erigena. Therefore, this ultimate break with the old world view of Ptolemy was accomplished not with a Charles Darwin type personality but with two church fathers fully familiar with the spiritual consequences of the doctrines as taught by Dionysius.

When Copernicus died in 1543, the medieval world was not yet ready for his heliocentric theory. His text was given over to Giese, protestant bishop of Kulm, then to fellow professor Joachim Rheticus and finally to a Lutheran theologian named Andreas Osiander. When finally published as DE REVOLUTIONIBUS ORBIUM COELETIUM, Osiander added a preface that said, "these hypotheses are not necessarily true or even probable". His work was firmly rejected by Tycho Brahe, the greatest observational astronomer in modern times. On his deathbed, Tycho passed his volumes of planetary tables to Johann Kepler (b. 1571) with a solemn promise that Kepler not abandon the theory that the sun moves around the earth and that all the other planets move around the sun. Finally, when Kepler published his three laws of planetary motion, the scientific revolution from Ptolemy to Copernicus was completed, both spiritually and physically.

We have then, beginning the 17th Century a complete separation of the physical and spiritual worlds, similar to the separation of earth-moon from the sun and the later separation of moon from the earth. The Ptolemaic system is an accurate picture of the realms of the rulership of the spiritual hierarchies with the earth at the center. The Copernican system is an accurate picture of the physical planets and their motions in space and time, with the sun as center. Because of this historical fact, it is true that since the 17th Century, mankind has ceased to be conscious of the spiritual world and modern science is divorced from religion. Kepler can be said to be the last deeply religious, occult and mystical scientist. To this fundamental realization of man's cosmic mistake and the scientific revolution of the Copernicus system, no one really understands, nor is there a solution.

This script has been written in the Astral Light, the Akasha, for all the angelic hierarchies to read and ponder. Now THEY know that we as mankind know our relationship to the spiritual worlds has forever changed. Mankind is truly alone until the earth re-unites with the sun in some distant manvantara

SPHERE	ORDERS	SEPHIRAH	ANGEL	DIVINE
1. Primum mobile	Seraphim	Kether	Metatron	Ehieh
2. Zodiac	Cherubim	Hokmah	Raziel	Iah
3. Saturn	Thrones	Binah	Tzabkiel	Elohim
4. Jupiter	Dominations	Hesed	Tzadkiel	El
5. Mars	Virtues	Geburah	Samael	Elohim Gibor
6. Sun	Powers	Tipheret	Michael	Eloah
7. Venus	principalities	Netzach	Haniel	JHVH-Saboath
8. Mercury	Arch-angels	Hod	Raphael	Elohim Saboath
9. Moon	Angels	Hesod	Gabriel	Sadai-Elhai
10. Earth (elements)	Souls	Malkuth	Soul of Christ	Adoni

(Sandalphon)

In conclusion, we see the table of correspondences from Robert Fludd, above which is the holy trinity and below which is the earth, the kingdoms of nature, the four elements and the world of souls led by the soul of Christ, the future planetary spirit of earth. (An explanation of the Names of God appearing in the far right column.)

The Ten Names of God, with their Ideas, Orbs and Hierarchies Largely Explained

God himself though he be trinity in persons yet is but one only simple Essence, there are in him many Divine powers, which as many beams flow from him which the Philosophers of the Gentiles called Gods.

1. The first name of the Divine Essence is EHEIE and his Idea is called Cether, which signifies a Crown, the most simple Essence of the Divinity which the Eye seeth not and is attributed to God the Father and hath his influence by the Order of Seraphims, who the Hebrews call Hayoth Hecadoth, that is, Creatures of Holiness, and then by the Primum Mobile bestoweth the gift of being to all things filling the whole Universe, both through the Circumference and Centre, whose particular Intelligence is called Metratton, that is, the Prince of Faces, whose duty is to bring others to the face of the Prince, and by him the Lord spake to Moses.

2. The second name is JOD or Tetragrammaton. His Idea is Hochma, that is, Wisdom, and signifieth the Divinity full of Ideas, and the first begotten, and is attributed to the Son, and hath his influence by the Order of Cherubims, which the Hebrews call Ophanim, that is forms or wheels, and from thence into the starry heaven where he fabricateth so many figures as he has Ideas in himself, and distinguisheth the very Chaos of the Creatures by particular Intelligence called Raziel who was the ruler of Adam.

3. The third name is called TETRAGRAMMATON ELOHIM. His Idea is named Bina, viz., Providence and Understanding, and signifies Remission, quietness, the Jubilee, penitential Conversion, a great trumpet, Redemption of the world, and the life of the world to come. It is attributed to the Holy Spirit and hath influence by the Order of Thrones, which the Hebrews call Aralim, that is, great Angels, mighty and strong, and from thence by the sphere of Saturn administred from to the unsettled matter, whose particular Intelligence is Zaphkiel or Zazel the Ruler of Noah, and another Intelligence named Iophiel, the Ruler of Sem. And these are threesupreme and high Ideas, as it were seats of the Divine Persons, by whose command all things are made, but are executed by the other seven upon Earth, which are therefore called the divine Ideas framing.

4. The fourth name is EL whose Idea is Hesed, which is Clemency or goodness, and signifies Grace, Mercy, piety, magnificence, the Sceptre and right hand, and hath his influence by the Order of Dominions, which the Hebrews call Hasmalim, and so through the sphere of Jupiter, fashioning the Images of bodies, bestowing Clemency and pacifying Justice on all. His particular Intelligence is Zadkiel, the Ruler of Abraham.

5. The fifth name is ELOHIM GIBOR, that is the mighty God punishing the wicked, and his Idea is called Geburah, that is, power, gravity, fortitude, severity, rudgement, punishing by slaughter and war, and it is applied to the tribunal of God. The Girdle, the Sword, and the left hand of God, it is called Pachad, which is fear, and has his influence through the Order of Powers, which the Hebrews call Seraphim; and these through the sphere of Mars illuminate the Rosy Crucians to whom belongs fortitude and prudence. It draweth forth the Elements, and his particular Intelligence is Camiel the Ruler of Sampson.

6. The sixth name is ELOHA or a name joined with Vandabat, his Idea is Tiphareth, that is Apparel, beauty, glory, pleasure, and signifieth the tree of life, and hath his influence through the Order of Virtues, which the Hebrews call Malachim, that is, Angels, into the Sphere of the Sun, giving brightness and life unto it, and from thence producing metals and thereto make aurum potabile. His particular Intelligence is Raphael who was the Ruler of Isaac and Toby the younger, and the Angel Peliel Ruler of Tacob.

7. The seventh name is TETRAGRAMMATON SABAOth or Adonai Sabaoth, that is the God of Hosts, and his Idea is Nezah, that is, triumph and victory. It signifies the eternity and Justice of a revenging God, he hath his influence through the Order of Principalities, whom the Hebrews call Elohim, that is, Lords, into the sphere of Venus. Gives Zeal and Love of righteousness, and produceth vegetables. His Intelligence is Haniel, and the Angel Cerviel the Ruler of David.

8. The eighth name is ELOHIM SABAOth, which is interpreted the God of Hosts, not of war and justice but of piety and agreement; for his name signifieth both, and proceedeth his army. The Idea of this is Hod which is interpreted both praise, confession, honour and famousness, it hath influence through the Order of Archangels, which the Hebrews call Ben Elohim, that is the Sons of God, into the sphere of Mercury and gives eligancy and consonancy of speech and produceth living creatures. His Idea is Michael who was the Ruler of Salomon.

9. The ninth name is called SADAI, that is, Omnipotent, satisfying all, and Elhai, which is the living God. His Idea is Jesod, that is, foundation and rest, and hath his influence through the Order of Angels, whom the Hebrews call Cherubim, into the sphere of the Moon causing the increase and decrease of things and taketh care of the Ideas of the Earth, of the Rulers of the Twelve Divisions and of their Images or figures and of the Genii and keepers of men and distributeth them. His Genius is Gabriel who was the keeper of Toseph, Toshua and Daniel.

10. The tenth name is ADONAI MELECH, that is Lord and King, his Idea is Malcuth, that is Kingdom and Empire, and signifieth Church, Temple of God and a Gate, and hath his influence through the Order of Anamastick, viz., of blessed Souls, which by the Hebrews is called Assim, that is Nobles, Lords and Squires, they are inferior to the Hierarchies and have their influence in the sixteen figures of Geomancy, the twelve Ideas, the four Elements and their twelve Regions or places divided, the twelve Winds which come forth from the twelve Houses of the Earth and on the Sons of Men. And thus they give knowledge, and the wonderful understanding of things, industry and predictions, and the President among them is Methratton, which is called the first Creature or the Soul of the World, and Sorath or O distributeth his virtues. And after this manner do the Earthly powers receive their Commissions which are figuratively incorporated into seven and they again in their natures given it to twelve, which also in twelve places signify all things past, present and to come in all the world.
(Angel Magic, From the Ms Harley 6482 British Museum Library)

A LAST WORD

Sister Anne Catherine Emmerich says of St. Dionysius in her vision of the saint:
"I saw this saint in his boyhood. He was the child of pagan parents and of an inquiring mind. He always recommended himself to the Supreme God who enlightened him by visions in his sleep. I saw his parents reproving

him for his neglect of the gods and placing him under the charge of a stern preceptor; but an apparition came to him by night and bade him flee whilst his preceptor slept. He obeyed, and I saw him transversing Palestine and listening eagerly to whatever he could hear concerning Jesus. Again I saw him in Egypt where he studied astronomy in the place in which the Holy family had sojourned. Here I saw him, standing with several others before the school, observing the sun's eclipse at the death of Jesus. He said: "This is not in accordance with nature's laws. Either a god is dying, or the world is coming to an end!" I saw the preceptor himself, a man of upright intentions, warned to seek his scholar. He did so, found him, and went with him to Heliopolis. It was long before Dionysius could reconcile himself to the idea of a crucified God. After his conversion, he often travelled with Paul (as confirmed by the spiritual vision of Dr. Steiner). He journeyed with him to Ephesus to see Mary. Pope Clement sent him to Paris where I saw his martyrdom. He took his head in his hands, crossed them on his breast, and walked around the mountain, a great light shining forth from him. The executioners fled at the sight, and a woman gave him sepulture. He was then very old. He had had many celestial visions besides which, Paul had revealed to him what he himself had seen. He wrote magnificent works of which many are still extant. His book on the Sacraments was not finished by himself, but by another."

At his beheading on Montmartre, his blood was collected on a cloth called the Oriflamme, which later became the gold flame on the French flag. St. Joan of Arc carried the cloth into battle and there is a window in the cathedral showing St. Denis giving the Oriflamme to a Knight Templar.

SEPTENARY IN HUMAN AND ANGELIC EVOLUTION

1. The Pitris

The good Madame H.P.B. in the Secret Doctrine states that there are seven classes of Angels or Pitris, three incorporeal and four corporeal and two kinds, Agnishvatas and the Barhishads. All Pitris are called the progenitors or fathers of mankind and it is the difference between these two classes and the evolutionary lines that proceed from them that we will discuss here.

The Barhishads are commonly referred to as Lunar Pitris, and are possessed of the creative fire. They are responsible for physical evolution, round which nature has created the present physical form. They are the four classes of corporal bodies, the lower quaternary devoid of intellect, the hosts of the four material classes who originally created men simultaneously in the seven zones on earth.

As the Madame explains in Eastern occultism,

"It is, then, the moon that plays the largest and most important part, as well in the formation of the earth itself, as in the peopling thereof with human beings. The Lunar Monads or Pitris, the ancestors of man, became in reality man himself. They are the monads who enter on the cycle of evolution of Globe A, and who, in passing round the chain of planets, evolve the human form...at the beginning of the human stage of the Fourth Round on this globe, they ooze out their astral doubles from the ape like forms which had evolved in Round III. It is this subtle, finer form, which serves as the model round which nature builds physical man. These monads or divine sparks are thus the Lunar ancestors, the Pitris themselves. For these Lunar spirits have to become men in order that their monads may reach a higher plane of activity and self-consciousness, i.e., the plane of the Manasaputras, those who endow the senseless shells, created and informed by the Pitris with 'mind' in the latter part of the Third Root Race."

The other division of Pitris, the Agnishvatas, are commonly referred to as the Solar Pitris. They are possessed of the intellectual fire (agni) and are responsible for the implanting of the fifth principle (manas) in man as opposed to the lower quaternary (physical, etheric, astral, lower ego) in man created by the Lunar Pitris. In the sense that the heart is the center of the human body, these solar angels or fire Dhyanis are considered as the heart of the Dhyanic-Chohan body of celestial angels, as the sun is the heart of the solar system.

Their role in the evolution of humanity is understood only in connection with the Lunar Pitris. The human Pitris evolved the lower quaternary of man during the first three globes or kingdoms of the Fourth Round. During the evolution of the fourth kingdom, after the passing from an arupa to a rupa condition, the earth and its life forms become physical. The human evolved an animal form, but it was mindless, only a shell. The Lunar Pitris did not have the karmic background to endow the human form with a mind. Thus, the animal form of man evolved during the Polarean and Hyperborean root races only to find at the beginning of the third root race, a mindless creature incapable of further intellectual evolution. Because the solar Pitris and the lunar Pitris had evolved separately, the humankind of the Lemurian root race possessed only the lower quaternary, devoid of the fifth principle.

Refused to Create

The occult reason the Solar and Lunar Pitris evolved separately is because the solar Pitris "refused to create". Had they created along with the Lunar Pitris, then mankind would have evolved with all five principles together. There are several levels of explanation as to why the Agnishvatas held back and did not incarnate in man until the Third root races.

One reason is given by L. Gordon Plummer presumably derived from lectures of the Theosophical Society. At the end of each round including the last lunar round, all life forms go into a long pralaya or Nirvanic rest. There are many levels of Nirvana, with each spiritual entity going to that level corresponding to its attained state of consciousness. Thus, lower evolved entities go to a lower level than more highly evolved ones. Higher evolved entities go to a higher level of bliss and for a longer duration.

At the end of the third round, the Pitris were evolved animal monads destined to become human in the Fourth Round. As said before, there are seven classes of Pitris, and the Agrishnatti Pitris were of the higher three classes, being more advanced. Therefore, they stayed longer in their nirvanic pralaya and emerged later than did the less evolved human Lunar Pitris.

This concept is similar to what the good Madame H.P.B. states from a source in the Hindu Puranas, that since the Solar Pitris were of the three higher classes, they were incorporate or arupa, being more spiritual and intellectual. Because they were arupa, they had no astral body to sacrifice to the evolving humanity below. Their refusal to create was not so much as act of rebellion but one of karmic destiny.

In addition, evolution requires a lower class of angels to create inhabited globes and to deal with the dense matter on the physical plane. The good Madame further says, "Where there is no struggle, there is not merit. Humanity was not destined to be created by the first divine breath; therefore they are said to have to refuse to (create) and man to be formed by more material creators, who, in their turn, could give only what they had in their own natures, and no more. Perfection, to be fully such, must be born out of imperfection."

Descent of the Manasaputras

In the Apocalypse of St. John, we read about the great war in heaven, where Michael and his angels fought against the dragon. The great dragon was defeated and cast out and his tail drew "the third part" of the stars in heaven and did cast them to the earth. This third part of the stars in heaven corresponds to the three classes of Arupa Solar Pitris, the ones endowed with Manas or intelligence. Up to the beginning of the Third Root Race, the Lunar Pitris had evolved the lower quaternary but without mind or intelligence, the fifth principle called manas. Eastern occultism calls these Solar Pitris the "mind-born sons" or Manasaputras and the descent of the Manasaputras (the Prometheus legend in Greek) refers to their incarnation in the Lemurian Third root race as kings, Rishis, heroes and leaders of nations and migrations.

Since there are three classes of Solar Pitris, there will be three classes of mind-born sons when they incarnate in the third-root race. Some of these were Nirmanakayas from previous Rounds or Manvantaras and these of course came first and filled the minds of the elect of mankind as Rishis, kings and leaders of nations. Speech did not exist then nor did it have to since mankind recognized their superior qualities and followed them. The second class of Agnishuatta Pitris were far more numerous and incarnated in the vast majority of mankind who were "half ready" and received but a spark of manas. This average humanity of which we are a part needs only to proportionately develop manas during this Round and not to perfect it as in the case of the pre-maturely developed intellects of the first class whom we call "fifth-rounders".

The third class of Solar Pitris relates to the laggards at the close of the Lunar or third manvantara who were not ready to receive the spark of manas. These were the least evolved animals monads on the Lunar chain and had to evolve further at the beginning of this round to mammals. The animal has an astral body which survives for a short time after death, but it does not go to Devachan but instead spends a short time in the species group soul. The animal monad incarnates in a higher species and this incarnation must occur before the middle of the Fourth Root Race when the door shuts closed on further upward transmigration. Thus, certain animal monads evolving during this round and certain laggard Lunar Pitris can evolve into human monads but being the latest arrivals their intelligence is lowest in the chain. These late human monads can only incarnate in bodies of the savage, which has only a dim spark of manas. However, they still have the evolutionary possibility to reach the level of the second or average class of Solar Pitris at the end of this round, so as to incarnate as Sons of Wisdom at the beginning of the fifth Round.

Gorilla Man

Western esoterism describes the evolution of the Solar and Lunar Pitris a little differently, R. Steiner in his Foundations of Esotericism describes what exists as a Jehovah principle and a Lucifer principle. "Halfway through the Lemurian Race kama-manas appeared on the physical plane in the duality of the sexes. The God who brought about kama-manas was Jehovah. This is why H.P. Blavatsky called him the moon God; he is rightly called the God of Fertility. The sexuality which made its appearance in the Lemurian age, when we trace it backwards, in its higher, nature becomes the Second Logos."

With the separation of the Sun and Old Moon during the third manvantara, the Old Moon retained the power of reproduction represented in the kama principle of septenary man. Later, during the separation of the moon from the earth in the Fourth Round, the leader of the Pitris who remained on the moon was the Jehovah God, of Hebraic

tradition and also one of the seven Elohim of Genesis. The fifth principle, intelligence or manas, did not interest him. His intention was the perfection of form, the creation of beautifully formed human beings. However, this principle if exhausted to its limit would have produced beautiful but rigid, frozen forms and in addition, would also have expended the power of reproduction.

As a testament to the Jehovah principle, a classic example is visible today in the silver backed gorilla. This magnificent beast is tall, strong, healthy, handsome, intelligent and monument to the evolution of the JHVH principle of form. However, every naturalist who has studied and observed the species says that it is doomed to extinction because the species has a rapidly declining rate of reproduction. The female is still sexually receptive, but the male, the classic symbol of the species virility only has an erection about five or six days a year. This degeneration of the sexual impulse, the victory of form over function, is exactly what occultists predicted about the Jehovah principle of reproduction expending itself into extinction. The condor of the Andes Mountains in Chile is another example of the evolution of a magnificent flying form threatened to extinction because the female only produces a single egg every eighteen months.

On the other hand, there is a line of evolution where form is perfected but not at the cost of loss of sexual virility. In the insect world we see how ants and bees have virtually eliminated sexual reproduction from their social and individual lives. What is sexual and necessary for the reproduction of the species is vested in only one queen. Here lies great wisdom for the future of mankind where sex is replaced by work as the fabric of social structure!

Genius

Another approach to understanding the Luciferic spirits is in relation to micro-cosmic evolution of the seven principles. The seven principles in Eastern occultism (Sanskrit) next to their Western counterparts are and the macro-cosmic elements are:

MICRO-COSMIC	PRINCIPLES	ELEMENTS	MANVANTARA
1. Sthula-Sarira	Physical body	Earth	Old Saturn
2. Linga-Sariri	Etheric body	Water	Old Sun
3. Kama-Rupa	Astral body	Air	Old Moon
4. Kama-Manas	Lower/Higher Ego	fire	Earth
5. Manas	Spirit-self	Akasha	Jupiter
6. Buddhi	Life-spirit	Spirit	Venus
7. Atma	Spirit-man	Divine	Vulcan

During each of the seven planetary evolutions or manvantaras a Macro-cosmic element is evolved, which corresponds in man to the septenary micro-cosmic principles. Thus, during the Old Saturn Manvantara, the seed for the physical body was laid down by the Thrones and the Archai or Spirits of the Age achieved their human or fourth principle. During the Old Sun Manvantara, the seed for the etheric body was laid down by the Dominations or Spirits of Wisdom and the Archangels achieved their fourth principle. During the Old Moon Manvantara, the Might or spirits of Motion laid down the seed for the astral body and the Angels achieved their fourth principle. In each case, the corresponding Archai, Archangel and Angel achieves its fourth principle by actually inhabiting the human physical body (so far as it had evolved) on the earth.

This evolutionary progression continues so that during this fourth Manvantara, we collectively as mankind are to achieve the fourth principle and incorporate it into our physical body. This is the whole mission of this Earth evolution. At the end of this fourth planetary evolution, the lower quaternary of physical, etheric, astral and ego should be completely evolved in the general mass of humanity.

Simultaneously with the evolution of the fourth principle or ego during this Manvantara, mankind is given a glimpse or taste of his three higher principles of Manas, Buddhi and Atma. This was not the Divine plan of the Spirits of Form, but occurred as a result of the Luciferic spirits invading the human astral body after the middle of the Lemurian age. The higher triad is not scheduled to be evolved to the degree the ego evolves during this Round, as this will occur during the following Manvantaras. Thus, the plan of the Spirits of Form is during the next Jupiter evolution, the fifth principle or manas will be incorporated into the physical body to the extent that the ego will be during this stage. Likewise, during the Venus evolution, the sixth principle or Buddhi will be incorporated into the physical body and so, with the seventh principle during the Vulcan evolution.

In all, during this fourth planetary evolution, we as mankind only so to speak look up to the higher triad but do not embody it into our physical body. Thus, the general mass of humanity receives a spark of manas during the fifth root race, a spark of Buddhi during the sixth root race and a spark of Atma during the seventh root race. Manas will develop on the physical plane into a kind of hardened egoism, during the sixth cultural epoch, which needs to be overcome with altruism, during the seventh cultural epoch, but these sparks never reach the level of embodiment for the whole of humanity.

The Pitris during the third or Old Moon planetary evolution experienced the corresponding evolution of the seven principles as we do now during earth evolution. For these who had a normal development or as the good Madame H. P. B. would say, "those who ran the race successfully", would come over to the earth evolution with a normally developed physical, etheric and astral body, into which could be incorporated the ego. These normal Lunar Pitris form the general mass of humanity today.

However, some do not run the race successfully. These who run ahead are the moon adepts and those who fall behind are the Lunar Pitris called Luciferic spirits. Not every angel who fully developed its fourth principle during the Old Moon evolution, also fully developed the spark of the higher triad it received as we humans receive the spark during this earth evolution. Some angels may have only developed through the fifth principle, others through the sixth principle. They should have all developed through seven principles, but some were laggards and some the product of normal septenary evolution.

At the beginning of the fourth Manvantara, which is to proceed through seven rounds and forty-nine globes, R. Steiner says in the Cosmic Ego (1912) that there are two classes of Lunar Pitris, "First, those who had developed only their fifth principle and did not develop their sixth and seventh principle. (Second) those who had developed their sixth principle and but not their seventh". To this we can add a third class of normal human monads who had developed their three principles on Old Moon and came to earth evolution ready to develop their fourth (ego). Of these three classes of beings, only the normally developed human monads could evolve within a human physical body. The two classes of Lunar Pitris did not deserve nor could they attain nor did the possibility exist for embodiment in a human physical body. Thus, in order to continue developing their sixth and seventh principles, these Luciferic spirits penetrated the human astral body as a substitute for the physical body.

During the Lemurian and Atlantean Ages, there were some human monads who had prematurely developed their fourth principle and these persons were the first to be possessed by the Luciferic spirits. As discussed before, these persons became the leaders of humanity, of nations and migrations, kings, heroes and prophets. It is obvious that the great leaders of humanity were not normally developed persons. The great secret of cultural evolution lies in the fact that the intellectual (Manas) development of science, philosophy and mathematics and the Buddhi development of art, music and literature are directed by Luciferic spirits evolving in the astral bodies of normally developing mankind. The traditional role given Lucifer and his legions by the Western Christian exoteric church is that of the evil devil leading his spirits from hell to cause sin, disease and death. Obviously, this designation is misplaced when even the Western name for Lucifer means Light-bearer!

As human evolution has proceeded through the Atlantean Age and through four cultural epochs in the Aryan Root Race, so have the Luciferic spirits evolved their fifth and sixth and seventh principles. Now what we call a genius is a person who is possessed by a Luciferic spirit evolving his seventh principle. Sometimes, this may last only a few years, enough time to enter and leave the physical plane, but the results of genius leave an everlasting impact on our cultural traditions. And, for those Luciferic spirits who successfully develop their higher principles, they are redeemed thru mankind and allowed to pass on and complete their normal evolution in future Manvantaras. Such is a cosmic task of human evolution in developing the angelic hierarchies.

Orpheus Descending

During my lifetime, the musical world of rock and roll serves as the great play ground of the Luciferic spirits. Take a familiar example of Jim Morrison of the DOORS. At the age of 20, he was a college film student going nowhere. Suddenly, his ego was taken over by a Luciferic spirit and overnight a star was born. His music was very original and poetic, but with a dark underside of cruelty, parental anger, fear and death. His many monologues also spoke of that Luciferic symbol of antiquity, the serpent, which he called the MO-JO RISING. On the one hand, his many LSD trips put him in a place where his Luciferic spirit guided him creatively, but on the other hand, under the later influence of a witch, he attracted many dark demons from the astral world which carried with them very negative and self-destructive impulses.

He was not at the peak of his career when he committed suicide in Paris. My observation of this Luciferic phenomenon in rock and roll, is that at the upper flat length of the bell curve, the guiding spirit departs. If the creative artist has no "spiritual center" to hold his seven principles together, unvariably, manic depression and suicide results. In Jim's case, in Paris he realised that his Luciferic spirit had left him high and dry and without prolonging the agony of despair, he killed himself.

This course of events does not happen in all cases. For example, another singer, songwriter and political activist, Phil Ochs, rode the Luciferic comet to the top. He was compared to Bob Dylan. His bell curve flattened out around 1970 when he cut his final album. Unlike Jim Morrison, Phil struggled with what his biographers call "disillusionment, poor career choices and depression" over the next six years, until his suicide in 1976.

We actually observe three types of rock and roll stars, which by definition are drug dependant, possessed by Luciferic spirits. In the Morrison case, the astral demons wasted no time in leading the soul to suicide. The same can

be said about Janis Joplin, Jimi Hendrix, Kurt Cobain and Sid Vicious. In the second case of Phil Ochs, after he realised that his muse had left, he struggled and tried to pull his life together, but over time and having no spiritual center, he also surrendered to suicide.

The third type can be seen in a star like Paul McCartney formerly of the Beatles fame. Without question, when the Beatles split apart, the spirit departed in a hurry. But, McCartney did not go the path of the first two types. The essential difference with the third type is the nourishment of a "spiritual center." One can never give himself up wholly to his Luciferic spirit without maintaining an ego centered around a higher spiritual value. I do not personally know what held McCartney together, but it may be as simple as love, marriage and family, a spiritual value not common to rock stars. With Bob Dylan, it was religion and family. New Age critics scoff at stars who "get religion", but it is precisely having this spiritual center to fall back on that pulls artists thru when the spirit departs. Granted, getting religion takes many weird forms, such as, Jesus freaks, vegetarians, cultism and spiritualism, and this represents a low level insecure response to the loss, but they hold together and do not commit suicide.

Do not think for a minute that the Luciferic spirit enjoys leaving his host high and dry. The successful creative artist, such as Paul Simon, keeps his spirit over time by nourishing a spiritual center without being dragged down by the astral demons. No star has been thru more and lived to see the sunrise than Elton John, but, somehow he has kept his spirit, thru the rise and fall of astral demons.

The lesson here is simple. The Luciferic spirits need a warm body to develop their principles and we can ride the comet to fame and fortune, or we can consciously develop-in unity with the spirit-our higher principles around a Buddhic Center (6th principle), our higher ego, and enjoy the ride without a fall.

Soul Food

The Knights Templar take their name from the Temple of Solomon given to them by King Baldwin II after the victorious First Crusade. In Arabic, this temple is called Al-Aqsa and was built by Abd-Al-Malik at the site of the Temple Mount built by King Solomon. The Koran tells the tale of the night Muhammad the prophet was awakened by the Archangel Gabriel. He was led to the Kabba (built by Abraham) and there he mounted a beautiful snow white winged beast which flew him to the Temple Mount and former site of Razed Temple of Solomon in Jerusalem. Inside the Temple he had discourse with all the prophets who proceeded him, including Abraham, Moses and Jesus. Mohammad was asked by the prophets to choose a drink for refreshment, either milk or wine. He chose the milk and Gabriel said that this was a wise choice for him and his generations. Henceforth, the consumption of wine and other alcoholic spirits was banned from Arabic society.

This story has great symbolism relating to our Solar and Lunar Pitris. The food of the Lunar Pitris line of evolution is represented by everything relating to milk. This first form of human food dates from the pre-Lemurian Age of mammals feeding their young with their own milk. Occultists call milk, moon-food, and persons who nourish themselves on milk are called Sons of the Moon. Milk contains the Jahve forces of the moon.

Scientists have long recognized the difference in races and nations that can and cannot dissolve the milk sugar lactose in their stomachs. For example, an Irishman can drink a 16 oz. glass of milk and the same drink would give an Italian a belly-ache. Biologist Jared Diamond of UCLA recently divided all human nations into two groups, the "lactase race" and the "lactase-deprived race" saying that there is an actual gene for this enzyme which dissolves lactose. Other scientists say that everyone is born with this enzyme but that it stops producing itself in the stomach after infancy, in certain cultures, particularly the Mediterranean. Thus, there is an actual genetic basis for moon-food that has biologically evolved since Lemurian times and which now seems to be phasing itself out of racial evolution. The food of the Solar Pitris line of evolution is represented by everything relating to the upper part of the plant. The leaves, blossoms and fruit of the plant grow, live and die while bathed in the light giving forces of the sun. The plant proteins of nuts and fruit feed the lower body of man while the stem and leaves feed the middle body to nourish the heart and lungs. Occultists call all that portion of the plant that grows above the ground, sun-food and the farming and gathering peoples, Sons of the Sun. This was the second form of human food.

The difference between sun food and moon food is preserved in the Bible story of Cain and Abel. Cain was a farmer of the soil and represented the Sons of the Sun. Abel was a shepherd and represented the Sons of the Moon. The Jehovah forces of the moon worked their way into the forces of animal nature in the flocks of beasts who nourished their young with milk. Steiner says that, "It was a falling away from Jehovah when man went over to the sun-food. This is why Jehovah would not accept Cain's offering, because it was the offering of sun-food." Thus, the burnt offerings of pre-Christian animal sacrifice were intended for our moon Elohim, as an appeasement for the farming and gathering tribes of the rising Atlantean root-race.

A third type of human food was added during the evolution of the Fifth Root Race, when man added to his diet what he took out of the earth in the form of minerals. This includes the root part of the plant consisting of mineral salts that lies beneath the soil, out of the reach of the sun's rays. This also includes such plant tubers as the potato and the turnip. In addition, the mineral form includes all food forms prepared through a chemical process, such as applied to

plants and proteins and fruits. The representative of chemically prepared food products is wine because the grapes are sun-food worked over chemically by man and not by nature.

Thus, there is an evolution through the food groups of milk, plant proteins and wine corresponding to the Lemurian, Atlantean and post-Atlantean Ages, corresponding to hunting, gathering and farming and lastly, mining peoples. There is also a similar correspondence among the initiates of the various mystery centers. As can be seen from our Koran story of Muhammed the Prophet, the initiates of the Hindu, Persian and Egyptian epochs rejected the use of ceremonial wine. These three cultural epochs were repetitions of earlier cultural evolutions. With the beginning of the fourth cultural epoch in the Greek-Roman sub-race, we see for the first time an actual mystery cult celebrate wine was part of the initiation ceremonies. The Greek Dionysius was a wine God! This celebration of wine transferred over into the Christian culture when Christ turned water into wine at the marriage at Cana. Christ also inaugurated the celebration of wine at the Last Supper as a repetition of the giving of bread and wine by Melchizedek to Abraham, as he arrived in Jerusalem from Ur. Christ is the Son of Man in the sense that the Solar Pitris are the Sons of the Sun and the Lunar Pitris are the Sons of the Moon. Likewise, the Christian clergy are the Sons of Man since they daily celebrate the taking wine with each Mass.

Why is the Christian clergy instructed to drink wine at every Mass? It is because wine and all alcohol consumption represents a loss of memory. With the Atlantean atavistic clairvoyance, the etheric body had unlimited ancestral memory. The Christ event in the fourth cultural epoch represented the macro-cosmic ego of fourth principle being given to humanity for development throughout the remainder of earth evolution in this Manvantara. In order to fully develop the ego, it was absolutely necessary to suppress the memory and teaching of incarnation and Karma. For this reason, the Judeo-Christian tradition teaches the significance of this earth life and Karma has been turned into the doctrine of pre-destination (from St. Augustine to John Calvin). The difference in ego development between Western culture with its wine food and Eastern culture with its teaching of incarnation and karma is clearly evident. Since the Archangel Michael event in 1879, the teaching of incarnation and karma is ripe for the Christian culture. Hopefully, we shall see the clergy stop celebrating wine at Mass and also see a miracle of turning wine back into water.

2. DIVISION OF THE RACES **JHVH INFLUENCE**

As stated before, the Mission of earth evolution is the development of the Fourth principle or the ego, the human I. At the stage of the Third Root Race or Lemurian Age, man consisted of what was carried over from the three previous Manvantaras: the physical body from the Old Saturn age, the etheric body from the Old Sun age and the astral body from the Old Moon age. However, at this time, the ego had not yet descended into the human sheath, nor was there incarnation of souls because mankind was under the guidance of a common group soul, located on the Astral plane. In addition, the earth-moon planet was separated out from the ancient sun but was united as a single planetary body.

Had the earth remained united with the moon, the physical bodies of animal evolution would have become hard and calcified, leading to an evolutionary dead-end. Recognizing this problem, the Spirits of Form with help from the other Hierarchies, separated out the moon and with it all the dense, heavy matter that would have grounded humankind. In this sense, the moon is thought of as a corpse of the earth planet. The Elohim Jahve went with the moon and with him the forces of reproduction. Thus, during the Lemurian Age, the separation of the sexes occurred, the first "fall" of mankind into generation.

Sexual reproduction wrecked havoc upon the evolution of the human animal. Interbreeding among species of animals occurred resulting in all sorts of grotesque by-products. The beautiful astral bodies of the Apollo men sacrificed by the Solar Pitris during the Hyperborean Age were later degenerated into physical human bodies incapable of developing the ego principle. This was the darkest period of humanity and human evolution as we know it almost came to an end.

Two things needed to happen to save the human race. First, the principle of species heredity needed to be established. Probably the greatest achievement of Jahve was to evolve the biological mechanism of heredity to prevent species from inbreeding.

Second, a spiritual pralaya was needed to protect incarnating animal monads from entering these grotesque bodies resulting from the orgy of sexual reproduction. The Hindus still worship the monkey as a reminder of the sins of our fathers. Prior to the actual extrusion of the moon from the earth-moon mass, the life wave of incarnating human monads was descending upon the earth to begin their ascent through evolution. Certain souls also having incarnated several times an earth remained in the spiritual world of the earth's aura, and "refused to create" or descend again into these unsuitable Lemurian bodies. Certain other incarnating souls wanted to descend but found the Lemurian bodies too hardened and ossified.

As Steiner says, "only the very strongest souls were able to master the hardened matter sufficiently to incarnate on the earth; the others were obligated to withdraw again into the spiritual world". Thus, a sort of spiritual pralaya occurred as described in Occult History, and of course this resulted in a serious de-population of the human species on the planet.

Where did this life-wave of incarnating animal monads and previously incarnated human monads go? Steiner says that they were transported to other five planets that had formed out of the planetary substance, some to Saturn, Jupiter, Mars, Venus and Mercury. This was not a new concept, going back to Plato's Timaeus of Locri who says "She (nature) then took up the task of working out mortal and ephemeral living beings, whose souls were drawn in from different sources, some from the moon, others from the sun, and others from the various planets." A significant result of this sojourn to the various planets was that these souls could not come under the direct influence of the Spirits of Form residing in the sun and whose task it was to guide the racial evolution of humanity.

Earth Rotation

During this spiritual pralaya, the sun, earth and moon forces evolved into their astronomical relationship we now see. For example, when the Old Moon planet separated from the Old Sun during the third manvantara, although it followed an elliptical orbit around the Old Sun, the planet itself did not rotate in place. (For a planet to rotate on its axis, a Spirit of Motion is necessary to reside therein). It always kept its same side facing the Old Sun as the moon now does in respect to its orbit around the earth. Thus, during the Old Moon age, the activity of the Spirits of Form residing in the Old Sun was continuous, without alternating day and night.

During the Hyperborean Age, prior to the extrusion of the moon, our planet earth also orbited around our sun in a similar manner, keeping one side always facing the sun. However, after the extrusion of the moon during the Lemurian Age, the earth began to rotate in place causing day and night and the corresponding alternating activity of the Spirits of Form. This physical event was very important for the salvation of humankind after the separation of the sexes.

As said before, the greatest event of the Jahve Elohim was the evolution of the principle of species heredity. This event saved the human race as a populating species. However, it also grounded the evolving ego principle entirely in the earth aura. With the heredity principle, each animal species developed a group soul which was entirely bound to earth evolution. Early man evolving during the Lemurian Age also had a group soul. It was not until the end of the Atlantean Age that most individual souls had fully detached themselves from the group species soul. The animals of Eziekie'l's vision and of the Apocalypse, the bull, lion, eagle and man are ancient symbols of the work of the group soul on the etheric body during the first four sub-races of the Atlantean Age.

Thus, the evolution of the ego principle in each individual incarnating monad is simultaneously a separation of the individual ego from the unified group soul created in the plan of the Spirits of Form. As a result of the heredity principle, in each earth life the soul felt the existence of a group ego all the way back to the earliest ancestor and this ancestral memory was preserved in the etheric body. The down side to the Jahve achievement was that each individual ego was restrained from evolving as an independent soul, being always grounded in earth evolution. It was necessary to preserve mankind's contact with the higher spiritual beings who sacrificed their bodies for them. The physical solution to this problem of ancestral memory restraining the evolving earth ego from its contact with spiritual worlds occurred when the earth planet began to rotate on its polar axis. With rotation in place come alternating day and night. During the day, the human ego and astral bodies worked into the etheric and physical bodies. At night, this daytime activity ceased, and the ego and astral bodies separated from the physical and etheric bodies. In this body-free time during sleep, the ego and astral bodies communicated with the higher spiritual beings known as Angels, Archangels, and Archai. In this way, the higher spiritual beings could influence the ego and repair the damage to the astral body caused by the day consciousness Luciferic spirits.

Before the physical event of day and night, the incarnating ego on earth would have had no contact with the spiritual hierarchies during life and after death the ego would have returned to the group soul and been later reborn in another human body, without the spiritual union in a body free condition with the spiritual hierarchies. The more grounded earth ego can during sleep maintain its contact and retain memories of higher spiritual beings and during each successive incarnation evolve out of the group ego as an individual being. Examples of this accomplishment are plentiful. For example, the heroes of Greek mythology are actual beings who lived on the astral plane during the Atlantean Age with memory of that being retained by incarnating souls into the Aryan Age.

This condition of night time caused by the rotation of the earth allowed the ego and astral body to have spiritual communion with the members of the third Hierarchy of Angels, Archangels and Archai. Their influence was determined for this manvantara by working on mankind during the night while the ego and astral body were in a body-free condition during sleep. But what of the influence of the true leaders of earth evolution, the Spirits of Form from the second Hierarchy? They work thru the sunlight during the daytime and at night, their influence is stopped by cover of darkness.

During the Hyperborean Age, when the sun had separated out the earth-moon planet, the work of the Spirits of Form was continuous, because there was no night time. During the early Lemurian Age, when the moon separated out from the earth-moon planet and the earth began to rotate, the activity of the Spirits of Form was not continuous, but interrupted by the night condition. Would mankind evolve in a condition where the activity of the Spirits of Form was only half-fold ?

The solution to this problem came when the Spirits of Form sent the JAVHE Elohim to the moon. At the end of the Old Moon manvantara, 7 spiritual beings had evolved whom we call the Spirits of Form or Elohim and they worked from the sun to guide evolution. Other spiritual beings, who had not achieved their rank in the Hierarchy, needed a place to reside so as to continue their development and for this reason the sun separated out the planet Mercury for the Archai and the planet Venus for the Archangels. The sphere of the angels became the moon, after it separated out.

The activity of the Spirits of Form is embodied in the sunlight and it is in this sunlight that they fill the planetary cosmos with their mission during each manvantara. During the Old Sun manvantara, the mission of the Hierarchies created a "cosmos of strength." During the Old Moon manvantara, the Hierarchies created a "cosmos of wisdom." The mission of the Elohim during this earth manvantara is to create a "cosmos of love." As this earth evolution rests upon the foundations of the earlier manvantaras, our cosmos of love rests upon the pillars of Strength and Wisdom (represented by the pillars of Jochim and Boaz in the APOCALYPSE and in the Masonic tradition).

The occult laws of three and seven teach that from the unity proceeds, first the three and then the seven. The ancient mysteries taught that the sun was three-fold, as last expressed by Emperor Julian the Apostate at the close of the mysteries in the fourth century. The light of this three-fold spiritual sun is sevenfold in its rays of the spectrum as reflected in the seven Elohim collectively called the Logos by Gnostic and Hellenistic wisdom. It is in the rays of sunlight that the Elohim send down the forces of love to embody the mission of this manvantara.

With the separation of the moon from the earth, the Spirits of Form sent the JAHVE Elohim to the moon to continue their activity. During the day, the rays of love from the remaining six Elohim work on man's whole body from outside. But they cannot work directly on the ego and astral body because, during the day they are not in a body free condition, being incorporated in the other principles of man. However, at night during sleep, the JAHVE Elohim works on the ego and astral body in their body free condition thru the reflected light of the three-fold spiritual sun.

Return to Earth

With the reciprocal relations of the sun, earth and moon being established by the Spirits of Motion during this spiritual pralaya, the time came when these souls who had previously been removed to the planets, returned to populate the earth. This was the life wave of incarnating monads commencing during the end of the Lemurian Age and continuing into the Atlantean or Fourth Root Race. As the souls migrating to each race increased, so did the human population. Racial characteristics are a direct result of the different soul-lives experienced during the sojourn to the various planets.

The Lemurian continent arose in the area of the Indian Ocean. Australia and New Zealand are remaining portions of it. When this continental plate subducted a portion of the plate containing the nation of India collided with the continental shield of Asia causing the Himalayan Mountains to uplift. Life during this age was difficult. The continent was shaped with tremendous volcanic activity and at the other extreme with periodic glaciation. Surviving this great winter of the earth's discontent was one ancestral pair, the Adam and Eve of Genesis. Modern anthropology recognizes this fact with the theory that all humans have the same genetic link back to an original mother or Eve. This pralaya made it possible for human substance to be refined and suitable to receive the weakened souls. Until the middle of the Atlantean Age, the descendants of Adam and Eve were able to live in a more plastic substance than had been available before the extrusion of the moon. Thus, all the generations of persons evolving on earth are the result of propagation with the descendants of this ancestral pair. That an historical pair did survive the entire planetary evolution is now recognized by anthropologists as the Biblical or Mitochondrial Eve, which they genetically trace, for now, back 200,000 years to Africa

As the Atlantis land mass became isolated from the sea floor spreading of the Mid-Atlantic ridge, a continental island emerged supporting life and as the peopling of the earth increased, two evolutionary lines of souls emerged. First, there were those human generations whose souls coming from the various planets were from the first time appearing on earth. Second, there were those souls, the direct descendants of Adam and Eve, who had previously incarnated an earth, having never left it during the pralaya. This would require a racial line of the Adam-Eve descendants who were under the direct influence of the Spirits of Form and a separate racial line under the direct influence of the five planetary spirits, the Spirits of Motion. With the advent of incarnation through both soul lines, there appeared for the first time, individual human karma. This human karma increased as the number of individuals evolving their ego principle and separating from the species group soul increased.

Those souls descending for the first time from planetary space and incarnated in human bodies stood in a different relation to those souls who had already several earth lives behind them. The first group of planetary souls brought with them for their earth life only the conditions to which they experienced during their pralaya in the planetary spheres. The second group of souls added to each successive earth life, the earthly karma they acquired. Thus, over time, there appeared fewer and fewer of the young planetary souls appearing for the first time and more and more of the older souls carrying with them the fruits of past karma.

Thus, the first important aspect to recognize as a result of these two lines of propagation, is the moon nature of the physical and etheric bodies of evolving humanity. That ancestral pair that remained on earth during the period in the Lemuria Age when the earth-moon planet was united, also survived through that period in the Lemurian Age when the moon was extruded from the earth. That ancestral pair, the Mitochondrial Eve, experienced both the union of earth-moon and the separation of earth-moon. After the separation of the moon, the earth bears within it none of those physical elements that detached and went with the moon. Thus, the earth carries within it no trace of the moon forces but the human physical and etheric bodies do carry the forces of the moon densification. All generations of Adam and Eve bear the moon influences within the physical and etheric bodies while the astral and ego bodies bear the planetary influences brought by the souls returning to earth after the earth-moon separation from Jupiter, Saturn, Mars, etc.

The second important aspect to recognize as a result of these two lines of propagation, is the planetary nature of the astral and ego bodies of evolving humanity. The spirits of form, the Elohim, have in one way or another always worked upon man's physical and etheric bodies. Thus was accomplished directly from inside when the sun-earth-moon were united. It was accomplished indirectly from outside, when the sun separated from the earth-moon planet. Even after this separation, a part of the Elohim remained united with the earth during the earth-moon evolution. Then, after the earth-moon separation, the Elohim forces still worked through Jahue on the moon from the outside and from the inside through the reserved moon forces in man's physical and etheric bodies.

This work of the Elohim from inside and outside, both as a separate Elohim from the moon, such as Jehovah and as united Elohim from the sun, as the Logos can be recognized as the Solar Pitris line. This should not be confused with what was said earlier about the Lunar Pitris being the fathers of humanity. To the extent the Spirits of Form work on the perfect physical body and the higher chakras of the etheric body, this is the work done by the Solar Pitris. They had a general plan for the development of the physical and etheric bodies carried out by the Solar Pitris. However, this plan was modified by the influence of the Lunar Pitris and our present human form is the result of the combination of the two.

The important distinction here is the fundamental unity of man's physical and etheric bodies, created during the Old Saturn and Old Sun manvantaras, with the Spirits of Form working thru the Solar Pitris generational line. The astral body and ego came much later in the history of evolution and are associated more with the Lunar Pitris who intervened in the normal course of evolution and against the general plan laid down by the Spirits of Form. As a result of the intervention, the Lunar Pitris are associated more with the four lower principles or lower quaternary of man and less with the three higher principles.

Now, it was described previously, the Luciferic spirits in order to complete their own evolution, needed human sheaths to develop their sixth and seventh principles. It was also described that these spirits preferred those humans which had a more developed ego of fourth principle. This type of more advanced human is represented by the first soul type of the older souls descending from the Adam-Eve line. The union of the older souls with the Luciferic spirits produced the kings, prophets and leaders of humanity Steiner says,

"Although the Luciferic influence made itself felt at first only in the more advanced individuals, it soon spread out to others. The descendants of these advanced human beings intermingled with the less advanced. By this means the Luciferic power injected itself into the latter. The etheric body of the souls returning from the planets could not receive the same degree of protection enjoyed by the etheric body of those who had remained on earth."

Steiner refers here to the etheric body. To avoid confusion, it should be said that the Luciferic forces primarily attack the astral body first, but then work into the etheric and physical bodies over time.

Here lay the seeds for the destruction of the Atlantean races. We know the unevolved ego has its higher and lower aspects. In its higher aspect it looks up to Manas and in its lower aspect, it is drawn down to kama (desire) and the sexual principle of JAHVE, the lower quaternary. The Solar Pitris angels gave protection of the etheric body of the older souls of the Adam-Eve descendants. This line of humanity was called the "Sons of the Sun" and the higher ego in these Sun-Men was the Spiritual sun or Christ Spirit.

Not so fortunate, the etheric bodies of the young souls returning from the planetary spheres. Their higher egos were controlled by the presiding spirit of Motion of each respective planet, Jupiter, Mars, etc. The separation of spirits followed the recapitulation of the Old Saturn, Old Sun and Old Moon Manvantaras at the beginning of our earth

evolution. When the sun separated from the common planetary mass, the Spirits of Form or Elohim went with the sun where they remain.

It was their ordained task to guide human evolution with a series of seven etheric bodies, one for each of the seven spirits of form. In addition, each of the seven etheric bodies was to develop in sequential order, from first to last, with each sub-race dying out in order, similar to the way the Neanderthal Man died out with the rise of the CroMagnon man. However, just the opposite to the Divine Plan occurred because of the effect of the planetary spirits during the spiritual pralaya.

Instead, the highest planetary spirit of each respective planet decided to create its own separate racial line of evolution and in this way, the Atlantean races were distinguished by Jupiter men, Saturn men, Mars men, etc. In addition, the higher ego of each initiate and his followers was controlled by the respective planetary spirit. Thus, instead of seven races evolving under the guidance of the seven Elohim, with Christ as their leader, we have five planetary races separately evolving, each looking up to their planetary spirit as leader and highest "God".

Because of this evolution of diversity instead of unity, the greatest confusion has evolved among the great spiritual leaders of mankind. For example, the Madame H.P.B. says that Buddha is Mercury, and she is correct. For the Mercury race of incarnating monads, the higher ego of the initiates and religious leaders is the Mercury spirit revealed through Buddha. For this reason, they do not recognize the Christ as the highest spirit. When their initiates achieve the highest evolution possible, they look up and find the Mercury planetary spirit, because they are in fact generational descendants of the Mercury line. Only the initiates of the Sons of the Sun generational line after developing their three higher principles, can look up and find the Christ. In the same way, the initiates of the Jupiter race of Greeks looked up to Zeus as the highest God.

From this it is easy to see that the greatest minds and the most spiritual adepts could never agree that the Christ Spirit of the Sun man is the highest of the planetary spirits. There is a racial prejudice extending all the way back to the origin of their soul life in their respective planetary spirits.

The Race Spirits

A planetary spirit is another term for the logos of a planet. Historically recognized by every religion, they have been called by the Hindus, the Dhyani-Chohans and Kumaras; by the Gnostics of Alexandria, Ialdabaoth and his six sons (the Demiurge and the Aeons); by the Kabalists, the lower seven Sephiroth; by the Zoroastrians, the Star-Yazatas; recognized by the Egyptians in the seven chambers in the Cheops pyramid; in the mysteries of Samothrace, the 7 Kabiri; and by the Christians, the planetary Angels or the 7 Spirits before the Presence. They are the Virtues in the second angelic Hierarchy of Dominations, Virtues and Powers (Spirits of Form) and stand four stages higher than mankind.

It is easy to confuse these with the Elohim or Spirits of Form because they are both seven in number. The Spirits of Form, which stand three stages higher than mankind, have seven logi, six of them work from the sun and one from the moon. Exoterically, there are also seven planetary spirits, historically drawing their names from the seven ancient planets as Saturn, Jupiter, Mars, Sun, Mercury, Venus and Moon. But, herein lies a veil or blind.

The sun and moon are not related even physically to the other five planets, the sun is higher and the moon is lower. The moon is a planetary corpse of earth and the sun is a fixed star, again not even a planet. Therefore, it is only exoterically that the sun and moon are included in the numeration of the ancient planets. Esoterically, the sun and moon are blinds for two hidden planets yet to be discovered or manifested. The sun can be substituted for the planet Vulcan, whose orbit is within the orbit of Mercury, and the moon can be substituted for Uranus. Therefore, the five ancient planets and the veiled sun and moon represent the seven planetary spirits that originally took part in the formation of our solar system.

The other planets, Uranus, Neptune and Pluto did not belong to the formation of our solar system, but have been captured, and to the extent that they rotate on an axis, they too have planetary spirits, but they are not directly involved in earth evolution as are the ancient planets. Thus, the five planets of Saturn, Jupiter, Mars, Mercury and Venus are manifested in their influence as Race Spirits and the two veiled planets are unmanifested, keeping in mind that the planets are also septenary lives that evolve thru seven stages of embodiment, only the fourth of which is physical.

It is also important to keep in mind that the seven rays from the Spirits of Form and the seven rays from the five and two planetary spirits all influence the earth and mankind. Thus, as they interface, each planet is in esoteric conflict within and without by these two sources.

Now a certain arrangement had to be made when the moon extruded or geologically separated out of the earth. If the moon had remained united, human evolution would not have proceeded as we know it. When certain older Spirits of Motion had decided to remain behind in their evolution and not proceed to the hierarchy of Spirits of Wisdom, the normal Spirits of Form had to weaken their strength to maintain the equilibrium required to further evolution. " The Spirits of Wisdom established a colony upon the moon in order to preserve the equilibrium, and so from the

direction of the moon, compensating spirits work in upon humanity." This task was accomplished by the JHVH Elohim splitting off and going with the moon, while the other six Elohim remained united with the sun. The moon does not rotate so it is not inhabited by a Spirit of Motion, but it does pass light, although reflected from the sun. Thus, it does embody a Spirit of Form being that Old Testament entity known as Jehovah.

These held back Spirits of Motion have two faces. As Spirits of Motion, there are the planetary spirits whose sphere of influence extends up to each of the five ancient planets. However, in respect to certain qualities in which they have made sacrifice or renunciation, they act also as Spirits of Form. Thus, in a cooperative activity, we have working in our solar system, the activities of the normal Spirits of Form working from the sun and together with the activities of the held back Spirits of Motion, working from the other five planets. The effect of this cosmic arrangement is seen most dramatically in the development of the human races.

In Genesis the 7 Spirits of Form are called the Elohim and they have their activity centered in the sun. One of these Elohim split off when the earth separated from the moon and He works from the sphere of the moon. The creative forces of the Elohim stream down in the sunlight, six rays from the sun and one reflected as polarized light from the moon. Interacting with these rays of the Spirits of Form are the five planetary rays of the held back Spirits of Motion radiating from Saturn, Jupiter, Mars, Venus and Mercury. As discussed above, after the return to earth of the souls from their spiritual praylaya, each of the planetary spirits (in cooperation with the Spirits of Form) decided to create its own separate racial line as embodied by a distinct racial etheric body. They have produced what are known as the five root-races. The common human form and a unitary group soul was each created by the normal Spirits of Form, the racial modifications of this common form comes from the influence of the five planetary spirits also called Race Spirits.

The cooperation of the Mercury Race Spirit has produced the negro race characterized by the Ethiopian culture and its activities are reflected in the glandular system.

The efforts of the Venus Race Spirit has produced the Malay or yellow race and its activities are reflected in respiration as it effects the solar plexus and sympathetic nervous system.

The efforts of the Mars Race Spirit has produced the Mongolian race and its activities are reflected in the blood.

The Jupiter Race Spirit has worked into the Aryan-Caucasian race, the predominant type of this Fifth Root Race age. The Aryan race began in India and worked westwards, so that now, in this cultural epoch, its activities are reflected in the peoples of Asia Minor and Western Europe. Its forces stream in through the sense impressions as processed by the higher nervous system of the brain and spinal cord.

The last Race Spirit of Saturn works in the brown race of the American Indian. Its activities invade the glandular system tending to ossification and ending in human death. The Saturn spirit brings about the decay and decline of a racial line as represented in the past in the American Indian and in the future seventh cultural epoch in the American culture.

A special modification of these five racial lines occurred as a result of the plan of the Spirits of Form to incarnate the Christ Spirit on earth. Christ should have incarnated during the middle of the Atlantean age. This was the time ordained for the Spirits of Form to begin work on the human ego. However, the matriarchal cultures of the Atlantean peoples lagged behind and were not ready to recognize so significant an event. In addition, as a result of the Luciferic spirits invading of the human astral body during the Lemurian Age, the descent of the Christ Spirit was delayed as far into the future Aryan Age as the intervention of the Luciferic spirits lay in the past.

For this event a special racial type had to be prepared to serve as a vehicle for the incarnation of the macro-cosmic Christ ego. The genealogy of this racial line is preserved in the historical description of the 3 X 14 generations of the St. Matthew Gospel. Since the Mars race spirit works into the blood, a special cooperation had to be effected to prevent its activity in the blood line of the Hebrew generations. The spiritual mission of the Hebrew nation to prepare a physical body suitable to host such a great spirit, was led by the Jehovah Elohim from the moon and He worked thru the blood line. For this reason, JHVH is the God of the Hebrew nation who worked in the blood line of Abraham, Isaac and Jacob, thru the sons of the House of David and finally He appeared in the birth of the Solomon Jesus child.

The Temple Legend

In the previous discussion about Soul Food, we saw the profound wisdom of the Cain and Abel offering to the already predisposed Moon god, Jehovah. In the TEMPLE LEGEND Steiner lectures about another ancient mystery concerning this ancestral pair of brothers and their generational lines.

One of the Elohim created the primal mother called Eve in the Genesis Bible story. From their union the son Cain was born. Then another Elohim, called Adoni or Jehovah, created the primal man, Adam. From the union of Adam and Eve the son called Abel was born. Thus, from the beginning of human evolution, there were two distinct lines of evolution. Cain killed Abel and the Abel line later descended thru his brother Seth, born later to Adam and Eve.

After the fratricide, Cain travels east of Eden and begets his own race.

The wisdom of this myth relates to our Pitris and the separation of the races of humankind. The Cain line has been called the Sons of Fire and represents the Solar Pitris generational line in evolution. They are the farming and gathering peoples who till the soil, the Sons of the Earth. They are the creators of the arts, language and sciences, the workers in metals and ores as taught by Tubal-Cain.

The Abel line has been called the Sons of God and represents the Lunar Pitris generational line in evolution. They are the shepherds who take from the earth what it freely gives without effort and skill. From them descend the priestly line seen as the Brahmans of the Hindus, the Magi of the Persians, and the priests of the Temple for the Chaldeans, Egyptians and Hebrews. Beginning the fourth cultural epoch, the priestly line evolves into the succession of Kings as rulers of the masses. As such, the sons of Cain have been historically subjected to the sons of Abel.

With the building of King Solomon's temple, these two divergent lines came together for a brief reconciliation. Solomon came from the Abel line of priests and did not have the skills to design and build the temple. For assistance he had to seek the help of Hiram-Abiff, a son of Cain who had the necessary skills of geometry, metallurgy, architecture and building. Together they built the grand edifice to the Moon God, Jehovah. Although no temple was built for the God of the sons of Cain, the monument to their achievement was to be the casting of the molten sea or brazen sea. This was a huge mold to hold firm in bronze the movement of the waters, which if accomplished, would have made Hiram the greatest artisan in history.

Without getting into the details of this long story, which forms the ritual of the Third Degree in Masonry, the casting of the molten sea was destroyed by a conspiracy of three rejected masons seeking revenge upon Hiram. When the mold broke, a horrible catastrophe followed spilling molten metal mixed with water and fire, killing people and causing Hiram the greatest humiliation. The important part of the story concerns Solomon who was told by the workman Benoni of the plot and Solomon did nothing to prevent its execution. It seems the great Hebrew king had his own failings of greed and jealousy as Balkis, the Queen of Sheba, had taken a fondness to the power of Hiram. In grief, Hiram threw himself into the furnace that prepared the metal for the molten sea. There he met the "father of thy fathers, Tubal-Cain, son of Lamech" who taught him the weakness of Jehovah, whom we know from the Old Testament to be a vengeful and unforgiving God. He was also told, "A son shall be born unto thee whom thou shall indeed not see, but whose numerous descendants shall perpetuate thy race, which, superior to that of Adam, shall acquire the empire of the world...at last the best shall become the strongest, and restore on the earth the worship of fire. Thy sons, invincible in thy name, shall destroy the power of kings, the ministers of the Adonai's tyranny."

With the help of the grand master Tubal-Cain, Hiram successfully completed the casting of the molten sea, much to the disappointment of Solomon and again, gained the favor of Queen Balkis. Solomon again hatched a plot which ended with the murder of Hiram by the three fellow-craftsmen.

Historically then, we see an opportunity for the coming together of the generational lines of the sons of Cain and Abel in the building of King Solomon's temple. However, King Solomon used this meeting for his own selfish purposes. First, he builds the temple for his personal fame and glory, which he could not have otherwise done without help from the sons of Cain. Then he plots to get the favor of Hiram's sweetheart, Queen Balkis and lastly, he consents to a plot that gets Hiram murdered. To add insult to murder, he finally marries the Queen of Sheba and has children with her. Historically then, this opportunity to merge the generational lines did not occur as a result of the reprehensible acts of King Solomon.

The important part of the prophecy given to Hiram by Naamah, sister of Tubal-Cain, was that a son was to be born that would destroy the power of Kings. The rule of the sons of Abel began first as priestly rule in the temples and evolved over time into kingly rule. Historically, we have seen a transition from kingly rule to Parliamentary rule and Democratic rule in Western Europe and America. Arguably, the change from kingly rule to democracy occurred through the efforts of Rosicrucians in Europe and Masons here in America. The secret history of the French Revolution and the death of Louis XVI was a case in point.

Although Steiner does not identify the name of the son to be born, he does credit the origin of the Temple legend to Father C.R.C., Christian Rosenkretz in the 14th. and 15th. centuries. His birth in 1378 came shortly after the murder of Jacques de Molay and the total genocide of the Knights Templar in 1314 by Philip IV King of France and Pope Clement V. Steiner further says that the Rosicrucians were the successors to the esoteric tradition of the Knights Templar and he also confirms the spiritual identity of Father C.R.C. with the Comte of Saint Germain. Cazotte was an initiated Martinist. The Masonic Convention of Paris in 1785 was attended by Saint Germain and Cagliostro, who at the suggestion of Cazotte, predicted the events of the French Revolution and further gave the name of the Corsican, Napoleon Bonaparte, whose historical role was to revenge the Pope. Jacobinism took its name from Jacques. To realize the dream of Jean Jacques Rousseau, after his death, a Masonic lodge met in his former house to plan the conspiracy of the revolution. Before his death, the last King was held in prison in the old palace of

the Templars. These events were also predicted in the APOCALYPSE OF ST. METHODIUS published in the year 1527.

In America, most of our founding fathers were Masons, from General Washington to the succession of the early presidents. Ben Franklin frequently went to Paris for meetings. I wonder who was his council? At least for our cultures, the prediction of Naamah has come true and the lines of the sons of Cain and Abel have not yet joined.

The Atlantean Races

All persons in their successive incarnations pass thru the various races. Before heredity became the controlling factor of race, the geographical place where a man was born was determinative of racial characteristics. These geographical locations were controlled by the Spirits of Motion, whose influence radiated out of the earth and determined the whole life of mankind. There is an original development of man as reflected in the Mercury race in Africa. Here, the forces of the earth imprinted upon this race the characteristics of early childhood. Moving eastward to Asia, the Venus and Mars spirits imprinted upon the racial type those characteristics of youth. Moving westward to Europe, the Jupiter spirits imprinted upon the racial type the characteristics of early adulthood. Finally, in America the Saturn spirits imprinted upon the brown race, those characteristics dominating the last one-third of life, being old age and death.

Steiner says that the evolution of civilization assumes the character as shown by a continuation of the race line and this was a geographic line beginning in Africa, moving east to Asia and westward again to Europe and ending in America. In the American and Mexican Indian and the peoples of the Carribean Islands, we see descendants of the Atlantean races struggling to survive. They have no national identity as their folk-soul passed on thousands of years ago. Under the geographic influence of the Saturn spirits, these cultures are destined to pass away as racial development follows an ordained path from birth, childhood, youth, middle age and finally, into old age and death. The Atlantean races were the first Root Race to strictly sub-divide into seven racial types following the influences of the Spirits of Form and the race spirits. At various times during the evolution of the Atlantean races, migrations took place out of Atlantis to various geographical locations on the earth where they could receive the correct racial cultivation. The guidance of this distribution of races took place in the Mystery centers of various Atlantean Oracles. For example, the Manu of the Mercury Oracle guided his peoples to Africa to cultivate the Ethiopian race. In this way, the earth was populated by the racial types under the guidance of the Oracles of the Spirits of Motion. For this reason, as discussed above, the initiates of each Oracle looked up to their corresponding planetary spirit as its own "God".

From a portion of the elect and most advanced of the Lemurian Third root-race, the first sub-race of the Atlanteans developed. The task of this Fourth Root Race was to develop memory and language in the sense that the task of the Fifth Aryan Root Race is to develop Manas or cognitive thought. Drawing from Theosophical sources, in COSMIC MEMORY Steiner describes the seven sub-races.

The first sub-race was called the Rmoahals. Here, the vestiges of speech began and as memory increased so did the development of language. The word was sacred, magical and powerful.

The second sub-race was called the Tlavatli. Here, with the development of communal life, ancestral memory began. With the great deeds of men being preserved through memory, leaders emerged and their legacy was venerated through an ancestor cult worship.

The third sub-race was called the Toltecs whose descendants after emigration, consisted primarily of the Mayan Indians of the American continent. Here, the social community reached full development into an autocratic type state government, led by a king whose power and authority was passed from generation to generation.

The fourth sub-race was called the primal Turanians. Here, occurred the development of personality and ambition, which combined with an autocratic government, caused tribal wars and slavery.

The fifth sub-race was called the Primal Semites. In them, the origins of logical, cognitive thinking began as memories were compared and combined. The faculty of judgment developed. From this sub-race were chosen those persons led by the Jupiter Manu to begin and populate the future Fifth Root Race after the decline of the Atlantean race.

In the sixth sub-race, that of the Akkadians, the faculty of thought developed further into the origin of regulations of law and justice. Colonization began, and with it, the commerce of trade between tribes and nations.

In the last sub-race, that of the Mongols, the path of thought developed in the fifth and sixth sub-races, sort of turned in upon itself, returning to the vestiges of the fourth sub-race. Ancestral memory and ancestor cult worship returned as a stronger force over the ascending Manas force, which effects can still be seen today in the Chinese culture.

3. THE UNITY OF THE RACES

Sacrifice of the Ram

The Christ event represents the fusion of three mystery streams of occult knowledge, that of Buddhism, Zoroastrianism and Old Testament Judaism. In discussing the evolution of mankind, the Hebrew Semitic sub-race plays the most important role in the Aryan Root Race.

As a sub-race, the Hebrews had their beginning in the fifth sub-race of the Fourth Atlantean Root Race. They were called the Primal Semites and in them was laid the seed for logical, cognitive thinking. After the destruction of Atlantis, the most advanced from this sub-race were led by the Manu from Ireland eastward across Europe and the Middle East to the Indus Valley to start the first (Hindu) sub-race of the Fifth Root Race.

The purpose of the Fifth Root Race was to develop Manas on the physical plane and the quality the Manu looked for in these peoples was that of the intellect. The term "most advanced" used above for this sub-race does not mean the best hunters, farmers or shepherds, but the most advanced in the power of critical thinking.

As the Manu led the migration from Atlantis across Europe and the Middle East, certain portions of the peoples separated off and began independent cultures along the way. Those that eventually populated the Indus Valley and began the Hindu cultural epoch were not the most advanced in respect of intellect, although they had other qualities. Those peoples who later become the Semites in the third and fourth cultural epochs, stayed in the Middle East area and populated their generations.

One contribution made by the Hebrews was the preparation of the physical body to become a vessel for the incarnation of the Christ ego. The Christ could not inhabit an unsuitable body as represented in the evolving sub-races of the Aryan Age. For this reason, simultaneously with the descent of Christ thru the heavenly spheres, the physical, etheric and astral bodies of the Hebrew nation was being prepared thru the 3 X 14 generations of the St. Matthew Gospel, beginning with Abraham. The entire Hebrew nation descended from his son, Isaac and the generations from him cumulated in the birth of a single person, the Solomon Jesus child.

The more important contribution made by the Hebrew nation also began with Abraham and Steiner calls this the "sacrifice of the ram."

When Abraham came from the land of Ur or Chaldea, he met with Melchizedek, the most high priest of (Jeru)Salem. This meeting is memorialized in Genesis with the gifts of bread and wine. But Melchizedek must have given Abraham something else if he was destined to be the seed for the nation ordained to bear the incarnation of Christ.

We know from OCCULT SCIENCE that the etheric bodies of the seven highest initiates of the Atlantean oracles were preserved, this in accordance with the principle of Spiritual Economy.

"The sun (Christ) oracle knew the secret of producing, for this or that individual, the kind of human ether bodies that were possessed by the highest initiates of the other oracles. With this means at their disposal, counter parts of the most perfect ether bodies of the ancient initiates were preserved and later implanted in the individuals best fitted for the purpose"

Safekeeping of these etheric bodies was given to the Sun oracle who distributed them to the new oracles of the Fifth post-Atlantean Age. The type of etheric bodies preserved were those that had the least degree of separation between the physical and etheric bodies. Such persons were best suited to guide evolution through the age of the descent of Manas. They had less spirituality but had more thinking ability. Co-equal with this development was the separation of the individual ego from the Atlantean group ego. The loss of ancestral memory was inversely proportional to the rise of the thinking or Manas function of the ego. Steiner says, "the part of the ether body bound to the physical body transformed the physical brain into the actual organ of thought and only from that time onward did the human being feel his ego in the physical body."

Now, it is both an occult law and a biological law that every human capacity must have its beginning in one human individuality.

Such is required by the gene pool whether it be the convolutions of Brocca's brain for the faculty of speech or the larynx of the future androgynous man for the faculty of Kriyashakti to give birth from the power of the Logos.

Abraham was the first person in whom the faculty of cognitive thought first occurred in the gene pool. This is why he was recognized as the founder of mathematics.

In the GOSPEL OF ST. MATTHEW, Steiner identifies Melchizedek as the great initiate of the Sun oracle, in whom resides the power of producing etheric bodies of ancient initiates. In order not to confuse Abraham, Melchizedek appeared at their meeting bearing the etheric body of Shem, son of Noah, and progenitor of the Semitic sub-race after the Atlantean flood. To Abraham was imparted an etheric body of the type preserved by the Sun oracle within which the physical organ of human cognitive thought had its beginning.

The cosmic purpose of this organ of analytical, calculating reason was to develop the thinking function of the micro-cosmic human ego. It was truly a gift from the Gods. The meeting of the Sun oracle with Abraham was veiled in the Old Testament story of the meeting with Melchizedek. Likewise, the gift of the organ of thinking was veiled in the Bible story of the sacrifice of Isaac.

This story is nowhere told more beautifully than in THE BOOK OF JASHER which one can hardly read without a feeling of piety and dignity. Interestingly, Satan appears four times to Abraham while traveling the road to Mount Moriah with his sons Isaac and Ishmael. The first time Satan "appeared to Abraham in the figure of a very aged man, humble and contrite of spirit" and tried to persuade Abraham from making the sacrifice. But he "knew it was the word of Satan who endeavored to draw him aside from the way of the Lord" and Abraham rebuked him so that he went away.

A second time Satan returned and came to Isaac in the figure of a young man, comely and well favored. Again Satan was rebuked. A third time, Satan realizing he could not prevail over them, transformed himself into a brook, large and powerful as the mighty waters. As the travelers passed thru the stream, the water reached their necks and they were terrified. Suddenly, Abraham recognized the place and he knew there was no water there before. A last time he rebuked Satan saying, "The Lord rebuke thee, O Satan, begone from us for we go by the commands of God."

After Abraham was told by the Lord to substitute "the ram which the Lord God had created in the earth in the day that He made earth and heaven", Satan again appeared and caught the hold of the ram and entangled his horns in the thicket. Abraham freed the ram, placed it upon the altar for sacrifice and sprinkled some of its blood upon the altar, after which the Lord blessed Abraham and his seed. It is interesting to observe the many temptations made by Satan to prevent this event so important to the evolution of the Christ impulse.

Steiner says that the sacrifice of Isaac was a symbol of the sacrifice of the ancient clairvoyant thinking function of the ego, which had to be progressively eliminated from our gene pool so that the new cognitive thinking function of the ego, as represented by the generations of Abraham, could develop in our Fifth Root Race.

"The last faculty to be given up in exchange for the gift of the Hebrew people was connected with the sign of the Ram. Therefore, a ram was sacrificed in the place of Isaac (and) from Isaac the entire Hebrew nation descended." Steiner further discloses a greater occult secret when he says that, "the two horns of the ram symbolize the sacrifice of the two-petalled lotus flower." This two-petalled lotus flower is the sixth chakra of the etheric body corresponding to the brow.

In Eastern Occultism, it is the AJNA center called the third eye and is connected with the pituitary gland and the autonomic nervous system. Situated between the eye brows, it is the seat of intuition and cognitive faculties on the one hand and of clairvoyance on the other hand. As C.W. Leadbeater pointed out, technically, there are 96 spokes to this chakra but it is mentioned in the Hindu tradition as having only two petals, because it, "has the appearance of being divided into halves, one chiefly rose colored, though with a great deal of yellow about it, and the other predominately a kind of purplish-blue." Traditional Hindu occultism recognizes this center as a white lotus with two petals bearing the letters h and ks with a white triangle, apex pointing downward.

What then was given to Abraham by the Sun oracle was an etheric body which for the first time in evolution had the template of the physical body's organ for cognitive thought. However, in this etheric body, the brow chakra, representing the ancient clairvoyant thinking faculty as reflected in ancestral memory, was closed. The evolutionary plan of the Spirits of Form was to close this brow chakra so that after the evolution of cognitive thought in the Aryan age, this chakra could be re-opened to emerge at a higher level. In the future Sixth Root Race, this gift would be given back to mankind, so that clairvoyance could proceed from a person fully grounded in analytical, calculating and logical reasoning. Esoterically, these two petals of the ANJA chakra were closed and symbolized by the sacrifice of the ram.

The Fall of Mankind-One Key

This is not the first time in the evolution of the races that the Spirits of Form had withheld a gift from the Gods. As the good Madame H.P.B. says, every great symbol has seven levels of meaning and seven keys. One of the keys to the "fall of mankind" as reflected in the Garden of Eden Genesis story, is the withholding of the higher chakras in the etheric body.

Before the fall, the Spirits of Form had designed the human form with seven fully operative and functioning chakras within the human etheric body. The chakras correspond in the micro-cosmic principles of man to that, which in turn, correspond to the macro-cosmic principles of the Cosmic Elements, known in Eastern Occultism as the TATTVAS, as follows:

CHAKRA	TATTVAS	COSMIC ELEMENT	
1. Crown	Adi	Divine (Life-ether)	1 st . Logos
2. Brow	Anupadaka	Spirit (sound-ether)	2 nd Logos
3. Throat	Akasha	Aether (light-ether)	3 rd Logos
4. Heart	Tejas	Fire Ether	
5. Solar/plexus	Vayu	Air	
6. Sacral	Apas	Water	
7. Coccygeal	Prithivi	Earth	

However, during the Lemurian age of the Third Root Race, our Lunar Pitris, the followers of Lucifer, implanted themselves into the astral body of mankind. The results of this are also sevenfold, but, generally speaking, this descent into matter, earth passion, desire, freedom, evil, etc., was earlier than intended by the Spirits of Form. The effects of this event could not be reversed and the possibility existed, that over time, the course of evolution would require the Luciferic forces to also invade the etheric body of mankind.

If this occurred, the results would be devastating to mankind because of the super-human powers contained in the three higher chakras of the etheric body.

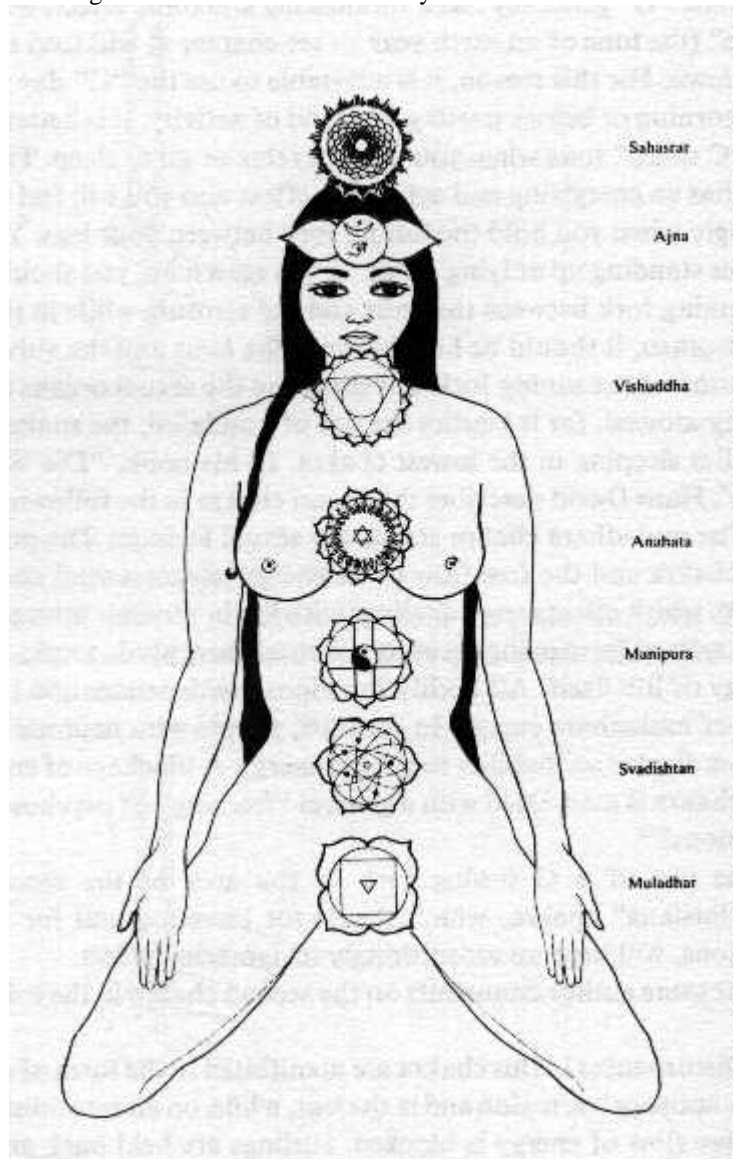

For this reason, the Spirits of Form withdrew the higher chakras of the etheric body to be preserved for a later time in the Sixth and Seventh Root Races, when mankind would be more highly evolved and mature. Thus, one key to the mystery of the Fall of Mankind, was the intentional closing by the Elohim of the higher chakras and the function of their corresponding organs, the larynx, pituitary and pineal glands.

For example, in the throat chakra, Steiner speaks in **KNOWLEDGE OF THE HIGHER WORLDS** that during an earlier stage of evolution, eight of the sixteen spokes had been closed and ceased their activity. The eight-fold path of the Buddha was an esoteric path to re-open them and attain their full intended use. "Man can now develop the remaining 8 petals by means of conscious exercises, thereby, the whole lotus flower becomes luminous and mobile." In Eastern Occultism, the good Madame H.P.B. speaks of the **KRIYASHAKTI** force. This has the power of producing on the physical plane material forms and objects through the potency of Will and Ideation. It was this force that caused androgynous man in the Lemurian (pre-Fall) root races to produce offspring without a sexual

union. In Western Occultism, it is this force that Steiner says will manifest itself in the future Sixth Root Race in the human (male) larynx to likewise reproduce without sexual union out of itself with the power of the creative word. If the power of this reproductive force were not withheld, mankind would most likely experience a second Fall, because of the failure of present humans to control the passions of the astral body.

Also, the ego functions of thinking, feeling and willing are reflected in the higher chakras and higher trinity of micro-cosmic principles. To the extent that a person has consciously transformed his astral, etheric and physical bodies, he has partially obtained, Manas, Buddhi and Atma. To a certain extent, all of mankind has achieved Manas and Buddhi, through the feeling and willing function of the ego. This is now more or less achieved unconsciously or instinctively by the work of angels in the astral body. All persons can say "I feel" and "I will" and their functions are reflections from the light ether and fire ether of the macro-cosmic elements. Therefore, we can say these chakras are partially open as Steiner says about the throat chakra.

However, we cannot say "I think" as reflected from the sound ether thru the brow chakra nor can we have the cosmic wisdom of "oneness" as reflected from the life-ether thru the crown chakra. This is a difficult concept to understand because, at first glance, of course every one believes he can think separate thoughts. But as Steiner says in THE GOSPEL OF ST. LUKE, "Whereas each man's feeling and will are personal, we immediately come into something universal when we rise into the realm of words and the realm of thoughts. No one individual can form thoughts that are his alone." And the secret to understanding this concept is said, "If thoughts were as individual as feelings we should never understand one another."

Our words create a cognitive set from which our thoughts arise. This is the basis for the Sapir-Whorf hypothesis of linguistic relativity that the thinking of a particular culture is affected by the structure of the language it speaks. Words have their origin in the sound ether and this ether extends upwards to the sphere of the moon. Where there is a common language, there is a common or uniform thought pool from which are drawn our thoughts. The Spirits of Form closed the chakra thru which this sound ether manifests itself in the human body. Likewise, the chakra was closed thru which the life ether gives meaning or the wisdom of "one-ness" to cognitive thought. Thus, there is a great difference in the etheric bodies of mankind from before the Fall and after the Fall. It is thru the path of initiation and adeptship that these closed chakras are restored.

The Lost Pleiad

The mission of the Hebrew nation was at least two-fold. First, their spiritual task was to prepare a physical body thru the 3 X 14 generations suitable for the incarnation of the macro-cosmic Christ ego. Second, their evolutionary task was to extinguish the mental faculty of the ancient clairvoyance and instill in mankind the physical organ of cognitive thought. The sacrifice of the ram was in a very real sense also the sacrifice of the Hebrew nation as a sub-race for over 2,000 years, until the birth of Israel in the 20th. century.

There are many references to the ancient legend of the lost Pleiad, although I personally have never come across it. In every great symbol there are seven levels and seven keys, one of which is the astronomical key. This key has been preserved in the tauroctony or bull-slaying scene from the ancient mysteries of Mithras.

Mithraism and Christianity fiercely competed for the souls of Western man from the first century A.D. to the end of the fourth century, when Constantine converted the Roman Empire to Christianity and the edict of Emperor Theodosius abolished by law the practice of the ancient mysteries. Arising at the same time and covering the same geographic area, Mithraism was truly, "the road not taken by Western civilization."

The scene of initiation for the candidates of Zarathustra were subterranean caves on the ceiling of which were symbols of the planets and the zodiac. Likewise, the initiations into the seven grades of the mysteries of Mithras occurred in a stone vault, now called a Mithraeum, which were also located underground or in temples made to look subterranean. Hundreds of these vaults survive to the present day and common to all of them was the central symbol of the tauroctony carved in stone.



The central icon is the scene of Mithras slaying the bull with a sword placed in its shoulder. Located around this central figure are figures of a snake, a dog, a raven, a scorpion, and sometimes a lion and a cup. Usually above the scene is an arch depicting the constellations of the zodiac. In the upper corners are busts representing the sun and moon and the seven ancient planets are always presented, sometimes as stars in the cape of Mithras. In all, the iconography of the scene depicts the complete astronomical drama of Mithras in the circle of the zodiac, the ancient planets and our trinity of sun, earth and moon.



7.5 Mithras with sky beneath his cape (CIMRM 245).

David Ulansey in his book *THE ORIGINS OF THE MITHRAIC MYSTERIES* (1989) has discovered the key to the astronomical symbolism of the animals in the taurocotony. Being familiar with the solar year of the precession of the equinoxes (our Messianic cycle), he places Mithras on the celestial equator as it was when the spring equinox was in the constellation of Taurus and the fall equinox was in Scorpio rather than now in the 20th. century when the spring equinox is in Aries. Starting with the spring equinox in Taurus, and moving west, the celestial equator passes through the following constellations: Taurus, the bull; Canis Major, the dog; Hydra, the snake; Crater, the cup; Corvus, the raven and Scorpius, the scorpion. In addition, the two torchbearers who usually appear in the scene, as Cautes represents the spring equinox and Cautopates represents the fall equinox. Lastly, with the spring equinox in Taurus, the summer solstice appears in Leo, the lion.

Ulansey's key is that "the taurocotony represents the astronomical situation which obtained during the epoch in which the spring equinox was in Taurus "

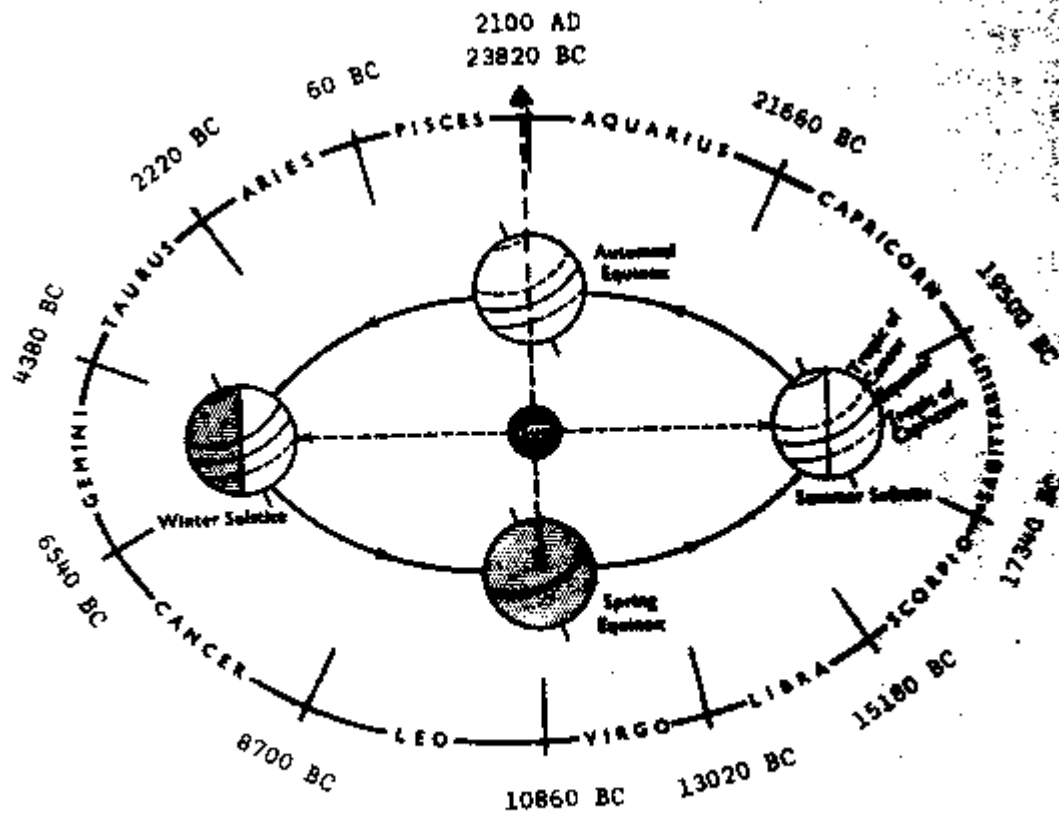
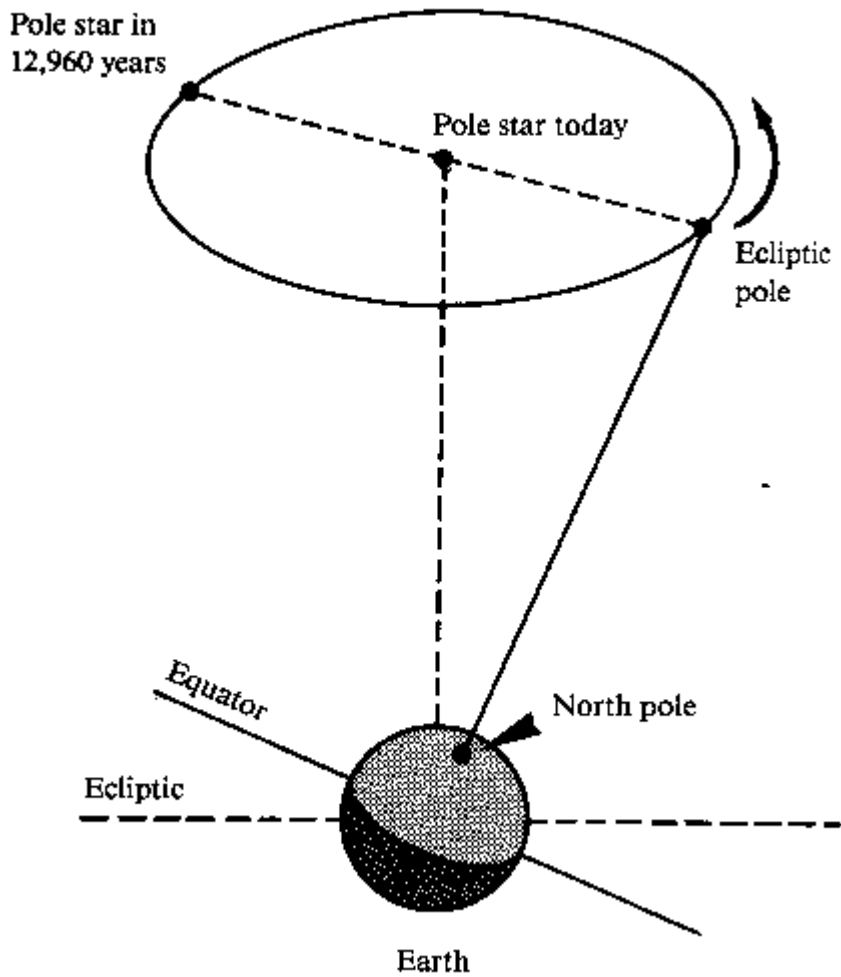

Fig. 98

and his conclusion is that the bull-slaying represents the death of the previous astronomical Age of Taurus brought about by the solar precession . With this analysis, I must agree.



Mithras slays the bull with a sword placed in the shoulder. On closer examination he observes," the position of the Pleiades located in the bull's shoulder is precisely the place where in the Mithraic taurocotony, the dagger of Mithras is entering the bull's shoulder and the left knee of Mithras is always shown in an exaggerated fashion pointing to just this spot."



Now Porphyry refers to Mithras as "a creator and Lord of Genesis." In an Old Testament sense, Mithras has been identified by him as an Elohim of Genesis, which would also make him a Spirit of Form.

Porphyry also describes Mithras as bearing the sword of Aries, which he says is "the sign of Mars." As described above in *The Race Spirits*, we know that the Hebrew nation had a special relationship with the Mars race spirit so that Jehovah could work in the Hebrew blood line of Abraham, Isaac and Jacob to secure the 3 X 14 generations. Thus, on a higher level of correspondence, the Mithraic taurocotony represents a Spirit of Form (an Elohim of Genesis) slaying the bull (the Age of Taurus) with the sword of Mars placed in the celestial position of the seven stars of the Pleiades. As a result of this slaying that occurred during the Age of Taurus, one of the seven sisters of the Pleiades is sacrificed or "lost" as represented by the position where the sword enters the shoulder.

In the *SECRET DOCTRINE* the good Madame says, "the constellations of the Great Bear and the Pleiades constitute the greatest mystery of occult nature...the six present and the one hidden." Most importantly, she also says, "the Pleiades were at one time the Atlantes and connected with Atlantis and its seven races." We learned above that the Primal Semites were an original sub-race, the fifth of the Atlantean Age.

I would suggest that the "greatest mystery" of occult nature is now solved. The lost Pleiad represents the Hebrew nation after the sacrifice of the ram by Abraham and this event occurred during the Age of Taurus and its astronomical key is represented by the Mithraic taurocotony.

The Universal Human

As we discussed before, the seven Spirits of Form had a general plan of earth evolution which was modified when the Spirits of Motion held back and became Race Spirits that populated the Atlantean Age with racial varieties. The evolution of these racial varieties has been much commented on in such books as A.P. Sinnett's *ESOTERIC BUDDHISM* and of course in *THE SECRET DOCTRINE*. In Theosophical parlance it was commonplace to speak of the progress of the Messianic cycles or cultural epochs of 2,160 years as co-equal with the evolution of the 7 X 7 sub-races for each Root Race.

However, Steiner has commented on several occasions that the differentiation of racial characteristics was a dominant factor only in the Atlantean root Races. As we progress over time, thru the Fifth (Aryan) Root Race and into the future Sixth Root Race, the significance of racial diversity will diminish over time.

The etheric body is the template of the physical body. Aside from racial characteristics our physical bodies are the same. However, there are seven distinct types of etheric bodies spread over mankind. The differences between these seven types correspondingly makes people different. The seven colors of the etheric body reflect the seven rays of the Spirits of Form. Although we can say that the five race spirits have produced the five basic human racial types, originally there were seven types, two of which have disappeared.

The plan of the Spirits of Form was to have these seven racial types with their seven etheric bodies proceed successively in evolution beginning the first sub-race of the Atlantean Age. Then, the first type of etheric body would have predominated as a racial form over the duration of that epoch. Then, during the sixth sub-race, the second etheric bodily type would have dominated, and so on consecutively seven times until the end of the fourth sub-race of the Fifth Root Race.

However, the forces of Lucifer and Ahriman worked against this plan as they work against all the plans of the Spirits of Form. Evolution is designed to have a beginning, middle and end. To the extent that any evolutionary force holds back past its planned termination, Luciferic forces are at work. When, for example, certain Spirits of the Age do not pass on at the end of an epoch, but hold back to maintain their influence over peoples of the next epoch, this is the result of Luciferic forces, throwing a body block across the path of normal evolution designed by the Spirits of Form.

During the Atlantean age, Luciferic forces held back and preserved the racial forms so that the first type developed alongside the second, and the first and second type developed alongside the third, and so on. Thus, instead of consecutive development there was concurrent evolution of the seven etheric types that obviously extends to this present day. The plan of the Elohim was to have one common human racial and etheric type, drawn from an unitary group soul, beginning the fifth cultural epoch (1413 A.D.).

One result of this plan was that the physical body as developed during the fourth cultural epoch of the Greek-Romans, was at its peak on the evolutionary scale. This highest human form was reflected in the sculpture of the Greeks in the Apollo-Zeus-Mercury types. Our human bodies are now on the descending arc of that curve beginning the fifth sub-race of Atlantis.

Additionally, had this divergence of the racial types continued as before past the Greek-Roman cultural epoch, evolution would have required the differentiation into seven separate and distinct racial types, each as different from each other as is a separate animal species. What we consider as racism now, would progressively worsen into a condition where the different racial types would not regard each other as belonging to the same species.

The Spirits of Form had to counteract this real evolutionary force separating humanity into seven etheric groups.

The solution was to send the Christ Spirit to earth to incarnate in a human body. After the Mystery of Golgotha, the Christ impulse works in two ways to restore both the physical and etheric bodies of mankind.

As concerns the physical body, we said before that the outer human form was at its peak during the Greek-Roman cultural epoch. However, the inner human form was at its lowest. Steiner in FROM JESUS TO CHRIST (1911) describes what he calls the human "phantom" as the "form-shape which as a spiritual texture works up the physical substances and forces so that they fill out the (human) form which we encounter on the physical plane."

Further he says,

"At the beginning of human evolution it was intended that the phantom should remain untouched by the material elements that man takes for his nutrition from the plant, animal and mineral kingdoms. But it did not remain untouched, for the Luciferic influence brought about a close connection between the phantom and the forces which man absorbs through his earthly evolution...Since the beginning of earth existence man has lived in a physical body which is subject to destruction, which cannot adequately counter the destructive forces with upbuilding forces...Man has lost the form of the physical body."

In Eastern occultism, the good Madame H.P.B. calls this phantom body the "Auric Body" or egg which, "is the chief principle of all, the luminous egg (Hiranyagarbha) of the invisible magnetic sphere in which every man is enveloped. It is the direct emanation (a) from the Atmic Ray in its triple aspect and (b) from Buddhi-Manas. The seventh aspect of this individual aura is the faculty of assuming the form of its body and becoming the 'radiant', the Luminous Augoeides...the reason why public mention of the auric Body was not permitted was on account of its being so sacred. It is this body which, at death, assimilates the essence of Buddhi and Manas and becomes the vehicle of these sacred principles, which are not objective, and then, with the full radiation of Atma upon it ascends as Manas-Taijasi into the Devachanic state...It is the silver thread which incarnates from the beginning of the manvantara to the end, stringing itself upon the pearls of human existence. After death, the Auric body remains either in the Devachanic state of consciousness, or in the case of an Adept, prefers the state of a Nirmanakaya."

Our physical bodies have evolved over millions of years from the original body of the Adam of Genesis. As a result of Luciferic influences invading our bodies since the Lemurian age, our phantom or auric egg has given over to

disease, dysfunction, destruction and death. This of course was not the intention of the Spirits of Form who reside within the phantom body. Christ, thru the Mystery of Golgotha, came to change all of this.

On another level of correspondence, the deterioration of the inner body of mankind resulted from the historical necessity of the liberation of the EGO, which also had been in preparation since the middle of the Atlantean Age.

Dr. Steiner says in *THE EVOLUTION OF THE WORLD AND OF HUMANITY* (1923),

"The astral body before the year 333 A.D. was such that the greater part, the more active part of it, was in the upper part of man and the less active part in the lower man; the middle man lying between the two. By reason of the upper part of the astral body being more powerful in those olden times, the higher Divine Spiritual beings were able to exercise thru it their great influence on human beings. It was part of the plan for the whole evolution of humanity that it should progress in a certain way: while that was the condition of man's astral body about 3,000 B.C., at about 1,000 B.C., the lower part of the astral body had considerably increased in size while the upper part had proportionately decreased. In the year 333 A.D., however, the upper part was about equal to the lower. This was the crises that occurred in the year 333 A.D. Since that time the upper part of the astral body has constantly decreased in size and man's development is furthered by this...If man had not experienced this diminution of the upper part of his astral body, the ego would not have gained sufficient influence; he would never have become free".

The problem here is the old double edged sword of the inversely proportional relationship. It is from the upper half of the astral body that man derives the strength to control the etheric an physical bodies. Thus, by reducing the size of the upper part, the health of all humanity would gradually diminish. The price of a free will was bought at the expense of increased illness. However, this fatal evolutionary impulse was overcome by the death of Christ and His resurrection in the glorious phantom body Just prior to 333 A.D., the healing forces of the phantom body of Christ forever entered earth evolution.

The physical body in which He incarnated at the time of the baptism at Jordan, had been prepared thru the 3 X 14 generations of the St. Matthew Gospel. Between the ages of twelve and thirty, the ego-less Nathan Jesus child resided in this human sheath. When the Christ Ego incarnated in the physical, etheric and astral bodies of the Nathan Jesus child, for the first time on earth since the "fall" of Adam, an ego was present in a human body that was untouched by the influences of Lucifer and Ahriman. For the three years between the baptism and the crucifixion, the Christ Spirit lived in a human body, the phantom of which had never been in the course of human evolution.

After His death and resurrection, what Mary Magdalene and the apostles saw as the figure of the risen Christ, was this luminous phantom, the *Augoeides* of Christ.

Christ left the seed of this phantom body for us on earth. In the past, when man returned from Devachan to incarnate on earth, he brought with him for his next earth life, the defective phantom which had been given over to disease, destruction and death. "With Christ there rose out of the grave a kind of kernel for the reconstruction of our human phantom, and it is possible for this kernel to incorporate itself in those individuals who find a connection with the Christ impulse." To the extent that a person takes in the Christ impulse, he also takes in part of the phantom body of Christ, which transforms the Adam Auric egg into the Christ Auric egg.

Similarly, during the evolution of Christianity over the fifth, sixth and seventh cultural epochs, those Christians that possess a transformed phantom body, share a common humanity with a rejuvenated physical and etheric body. In sharing the phantom body of Christ, humanity can unite the otherwise natural diversity of racial types. In the same sense that the physical body of mankind could be traced back to the Adam body, now and in the future, the phantom body of persons in whom the Christ Spirit dwells, can be traced back to the second Adam, the Christ. This is the path in which humanity unites thru the physical body.

The other path is thru the etheric body which is reflected on the astral plane and this relates to the mystery of the Second Coming.

Today, as we draw near the end of the second millennium, much is said about the Second Coming of Christ.

However, it must be made perfectly clear that this does not mean a return to earth in a physical body as mankind experienced in the Mystery of Golgotha. This extraordinary feat of white magic will never occur again and damn the torpedoes for those who say it will. One level of explanation is as follows.

Christ united with humanity only because the possibility existed that a held back portion of the etheric body was preserved in the spiritual worlds and did not participate in the "Fall of Mankind" as reflected in the Genesis Bible story. We discussed above that, "the Spirits of Form withdrew the higher chakras of the etheric body to be preserved for a later time." We know from the teachings of Steiner that in the Nathan Jesus child, there existed a human soul that went back to Adam before the Fall and this fact is reflected in the generations narrated in the St. Luke Gospel. He says, " the etheric substance withheld from Adam had been preserved and sent down to this child."

The fall of mankind is a symbol for the intervention by the spirits of Lucifer into the astral body of man beginning the middle of the Lemurian Third root race. Likewise, mankind experienced a second fall beginning the middle of the Atlantean Fourth Root Race when the spirits of Ahriman invaded the etheric body. And since the middle of the

Aryan Fifth Root Race, the Asuras began to invade mankind's physical body, which in the future epochs will cause an evil far greater than that caused by the legions of Lucifer and Ahriman.

Christ did not incarnate in the body of the Solomon Jesus child because this body participated in human evolution with numerous incarnations since the fall. As great and good was the ego of Zarathustra, his astral body given to Hermes and his etheric body given to Moses, it was tainted by the forces of Lucifer and Ahriman that existed after the fall. Only in the Nathan child did an etheric body exist that was the brother of Adam as it existed before the Fall, that had no previous incarnations and as such did not carry the karma of earthly evolution.

The reason why there is no Second Coming is that this brother soul of Adam was spent on the Nathan Jesus child (and also on St. John the Baptist) and none others exist in the spiritual worlds. At the age of twelve, when the Nathan Jesus child cast off his astral body, it rose upward and united with the Nirmanakaya of the Buddha. Thus, at the Temple scene, the Nathan child consisted of a physical body, an etheric body of an Adam type that bore no earthly karma, an astral body that was united with the Nirmanakaya of the Buddha, that also bore no earthly karma and the ego of Zarathustra. This person lived on earth from age twelve until age thirty when at the baptism at the Jordan, the macro-cosmic Christ ego descended and replaced the micro-cosmic Zarathustra ego. This incarnation of the Christ ego into the sheaths of the Nathan child was a tremendous chance of white magic and a once in evolution event, never to be repeated again.

This is what the occult law of sacrifice means. At every level of evolution, in each of the nine levels of the Angelic Hierarchies, the possibility exists for a spiritual being to hold itself back, to renounce its advance to the next hierarchy, in order to preserve the possibility of redemption at a critical moment in evolution. Of those Solar Pitris who "refused to create", the angel of the Nathan Jesus ego held back descent to the physical plane until the age of King Herod.

In a similar way but on a higher level in the Hierarchies, the arch-angelic body of the Christ Spirit itself held back during both the Old Sun and Old Moon manvantaras to preserve the possibility of the redemption of mankind in the future Earth Round. Even if Christ could descend thru the spheres again, as He did prior to the Mystery of Golgotha, He could descend only so far as an angelic body because his physical body has been spent. The fruits of this physical body of the Nathan child is represented by the Phantom body discussed above.

After His crucifixion on Golgotha, Christ experienced physical death in every sense that we do when we die. As such, His higher principles are ascending upwards thru the spheres in the opposite direction that He descended downwards thru the spheres to incarnate here on earth. Now a normal person after death also discards his physical and etheric bodies and ascends thru the astral worlds of Kama-Loka (purgatory) and then the divine spheres of lower and upper Devachan (heaven). Then, with his phantom body or auric-egg bearing the seed of his higher trinity of Manas, Buddhi and Atma, he descends down thru the spheres to another earth incarnation. What draws man back to earth for repeated incarnations in a physical body is his karma, his unpaid debt owed to the physical plane.

With the Christ, the situation is entirely different. As discussed above, the etheric body of the Nathan child bore no earthly karma from prior incarnations and his astral body was perfected by none other than the Buddha, now residing in his Dharmakaya body in Nirvana. The Christ ego, during His three and one half years of the ministry, also bore no earthly karma. Therefore, after the physical death at Golgotha, the resurrected phantom body of Christ, carrying His higher six principles, bore no karma to return to earth.

Christ, like a Buddha who enters Nirvana, can never incarnate in a physical body again because there is no karma to connect Him to the physical plane. Like a Buddha, who still continues to help mankind in a physical body of a Bodhisattva thru his Nirmanakaya on the astral plane, Christ continues to help mankind thru his angelic body. But, both the Buddha and the Christ can appear only so far down as the astral-etheric plane, never again on the physical plane.

It is for these reasons that Steiner says that there is no Second Coming of Christ in a physical body on earth. Christ will return in an angelic body on the astral-etheric plane where He can be experienced clairvoyantly by those persons who can raise themselves to this level. It is at this etheric level that those who can say "the Christ in me" will unite mankind in a universal brotherhood, regardless of nation or religion. A true unity of humanity from within to oppose the diversity of humanity arising from without by the race spirits.

In *CHRIST IN THE TWENTIETH CENTURY* (1913) Steiner says,

"When the Mystery of Golgotha took place, the earthly body of Jesus of Nazareth was given over to the elements of the earth and from that time onwards Christ has been united with the spiritual (etheric) sphere of the earth and lives within it...He manifests Himself directly as an angel...This angelic being, who since then has been an outer form assumed by Christ, suffered an extinction of consciousness in the course of the intervening 19 centuries as a result of the opposing materialistic forces brought into the spiritual worlds...This onset of unconsciousness in the spiritual worlds will lead to the resurrection of the Christ consciousness in the souls of men on earth...from the 20th. century

onwards, an ever increasing number of persons will be capable of perceiving the manifestation of the Etheric Christ, that is, Christ in the form of an angel"

In the fourth Greek-Roman cultural epoch, Christ appeared in a physical body on the physical plane. In the fifth epoch, beginning the 20th. century, Christ will appear in an angelic form on the astral plane. In the sixth epoch, Christ will appear in an

astral form on the lower Devachan plane to prepare for the coming of the Maitreya Buddha. In the seventh epoch, Christ will appear on the higher Devachan plane. "I am with you always, even unto the end of the world."

Conclusion

In conclusion, the Law of Seven teaches that evolution begins with the one in unity, in this case the plan of the Spirits of Form, and then separates into the Three, the three-fold sun and diversifies into the Seven, in this case the plan of the Race Spirits. After the evolution of the septenary, there is a return towards unity, which in this case is the unification of humanity through the Christ impulse.

The secret of evolution and of the spiritual guidance of humanity has not been better stated than by Steiner in THE GOSPEL OF ST. LUKE,

"In order that humanity may advance, provision has always been made for two streams of civilization, one of which receives into itself the rudiments of certain faculties and elaborates them, while development of the other, adjacent, stream is as it were held back. The one stream develops certain faculties to a suitable degree-faculties which are then essentially part of this stream and of the men belonging to it. Evolution proceeds, and something new appears; but the first stream would not be capable of rising to a higher stage through its own powers. Provision has therefore to be made for another stream to run side by side with it. This second stream remains in a certain respect undeveloped, having not nearly researched the level of the first; nevertheless it continues its course and is eventually able to benefit from the faculties acquired by the first. Having in the intervening period remained youthful, it is able, later on, to rise higher. Thus the one stream has fertilized the other. Spiritual streams must run their course side by side in this way in the evolution of humanity and provision must be made accordingly by the spiritual guidance of the world"

SYMBOLS OF SEVEN

1. Cube and Triangle

The most simple symbol for the septenary in man is the division by Sinnett into the lower quaternary represented by a square and the higher triad represented by the triangle,(alchemical symbol)as follows:



7. Atma
6. Buddhi
5. Manas
4. Ego (Kama Rupa)
3. Astral (Linga Sartha)
2. Etheric (Prana)

1. Physical Body

Again, we see our factors of the three and the four, now this time as the number seven as a compound of the three and four. The reason for this correspondence is because the Law of Seven is the factor element in nature and the occultists recognizing this principle made it also the factor element in every ancient religion and culture, including the Hindu, Chaldean, Babylonian, Persian, Egyptian, Hebrew, and Pythagorean.

Thus, the triangle as three represents the triple aspect of Deity, the unmanifested cosmos, and in man, the future evolution of the three higher aspects of spirit. The square as four, represents the manifested world of matter and in man, the product of earth evolution of the ancient four elements of fire, air, water and earth as well as the earth's evolution of the mineral, plant, animal and man kingdoms of nature. Every man is a quaternary representing the earth elements and earth evolution of the four kingdoms. Man number five, either as a result of his own efforts or the future evolution of mankind as a whole, is represented with the triangle resting congruent on the top of the square as this is why in our present fifth (Aryan) root race, man is called a pentagon or five pointed star. This represents the goal of our present evolutionary epoch as the incorporation of the fifth principle (Manas) into the lower man. In the sixth epoch, the sixth root race will conquer the sixth principle and after the evolution the seventh root race, mankind having the higher triad inside him will be symbolized as, with the triangle wholly inside the square.

2. CUBE UNFOLDED

The most ancient symbol for the septenary in man is the Tau cross or T. It was formed from the figure of 7 affixed to the Greek letter (Gamma) as a double glyph. The letter gamma is the symbol of earth life or Gaia and the figure 7 is the symbol of the divine life taught by Pythagoras as the perfect divine number known as Telesphoros. Together as a double glyph, they represent earth life and divine life linked together eternally. In addition, the horizontal line represents the Female or matter and the vertical line the Male or spirit.

The Egyptians added to the perfect Tau a mundane circle (above) as an attribute of Isis which has come to be known as Ankh (life) or ansated cross as their symbol of eternal

life. The Madam H.P.B. relates that the Ankh cross symbol is another form of Venus as Isis as . It represented esoterically that mid-point in the third root race when the separation of the sexes occurred, when human procreation descended from androgynous Adam and separated into man and woman and procreation of the species through sexual union. Thus, the first "fall" is mankind and all animal life dropping out of the divine spiritual circle and fallen into male and female generation. Symbolically, the divine becomes , then and finally .

However, the Ankh cross of the Egyptians has a much deeper symbolic meaning. We saw before that the fourth Sephiroth HESED represented the Sephiroth of construction as the six dimensions of matter creating the manifested cosmos. It was symbolized by a six-sided cube with the Hebraic script value of 72. Also, the lower quaternary of man, the first four principles, is represented as square or three dimensional as a cube. This cube of earth-man unfolded represents a very esoteric septenary symbol as union of the three and four. J. Ralston Skinner in *The Source of Measures* states,

"If it is desired to display the process of the establishment of the co-ordinating unit of measure spoken of, by way of symbol, it would be by the figure of the cube unfolded, in connection with the circle, whose measure is taken off onto the edges of the cube. The cube unfolded becomes, in superficial display, a cross proper, or of the tau form, and the attachment of the circle to this last gives the ansated cross of the Egyptians, with its obvious meaning of the origin of measures."

"It is very observable that, while there are but 6 faces to a cube, the representation of the cross as the cube unfolded, as to the cross-bars, displays one face of the cube as common to two bars, counted as belonging to either; then, while the faces originally represented are but, the use of the two bars counts the square as 4 for the upright and 3 for the cross-bar, making 7 in all. Here we have the famous 4 and 3 and 7."

Thus, on one level and with one key, Skinner shows that the cube unfolded represents the septenary principle in man, the three and four united in a symbol of seven. The Egyptians made the Ankh cross their symbol of man, generation and life and buried their dead with it. But how old is this symbol? Skinner further states that the Aku-aku Cyclopean statues on Easter Isle in the mid-Pacific bear this symbol carved in stone. These islands are the remnant tops of mountain ranges on the ancient submerged continent of Lemuria, the home of the third root race. Madame H.P.B. was right when she said the ansated cross was a third root race symbol, millions of years old.

**PLATO'S MACROCOSMIC
ASTRONOMICAL WORLD
CROSS 3 + 4 + 7**

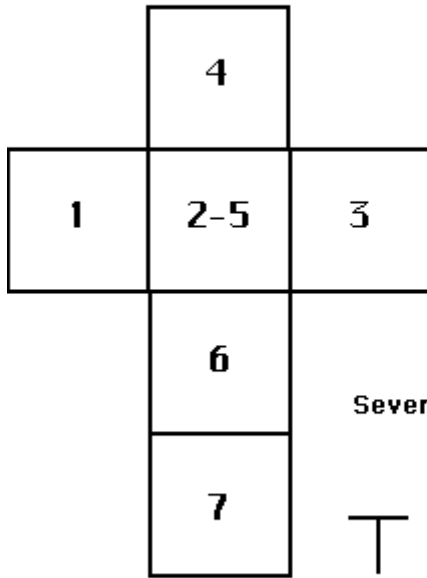

**MICROCOSM = MAN
CIRCLE ADDED TO TAU CROSS
MAN (113) - YEAR (355) = Π**

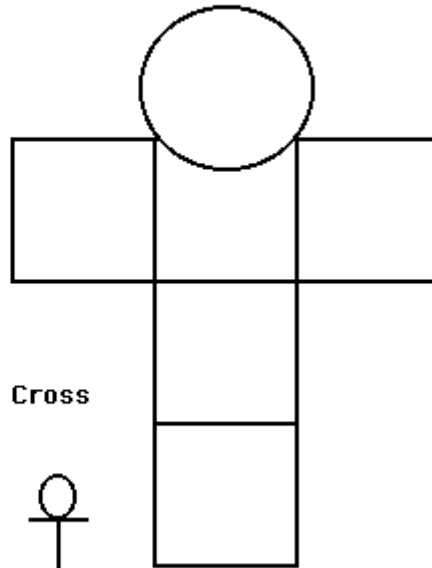

$$7 + \Gamma = \text{T}$$

Seven + Gamma + Tau Cross
Double Glyph

$$\text{T} + \text{O} = \text{O-T}$$

**Tau + Sphere/Circle
or man's head = ansated (ankh) cross**

On another level, using the Hebraic script numbers as a key, Skinner discovered another occult correspondence with the cube unfolded. In Hebrew, one of the word forms for man is ATSH and adding the value of the letters (300 +10 +1) is 311 or reading from right to left in Hebrew is 113. The Hebrew word for lunar year or SHANAH (50 +5 +300) or 355. As shown in Plat No. , the cube unfolded is an astronomical symbol of the macrocosm and with the circle attached to the tau cross as the head of a man "circling the square", it is a symbol of the microcosm or man. The ratio of 113 to 355 is an ancient value for the ratio of the diameter to the circle or (3.1415).

Thus, the cube unfolded is also an ancient symbol of the primary mathematical relationship of and as Skinner says, an origin of measures reflected in number form in the cross. This Hebrew word for man represented as 113 was probably the "primordial word" of the Hebrew script.

By welding man to the tau cross we also have the concept of the crucifixion in the microcosm and "man crucified in space" in the macrocosm. Skinner says,

"In fact, the Old Testament is rabbinically and kabbalistically familiar with the expression of crucifying a man, or men, before the Lord and the sun. In symbol, the nails of the cross have the shape of the heads thereof a solid pyramid, and a tapering square obeliscal shaft, or phallic emblem, for the nail. Taking the position of the three nails in the man's extremities, and on the cross they form or mark a triangle in shape, one nail being at each corner of the triangle. The wounds, or stigmata, in the extremities are necessarily four, designative of the square; there have been two used as one, or rather one used as tow, in the connection of the three nails with the four extremities. The three nails with the three wounds are in number 6, which denotes the 6 faces of the cube unfolded, on which the man is placed; and this in turn points to the circular measure transferred onto the edges of the cube. The one wound of the feet separates into two when the feet are separated, making three together for all, and four when separated, or 7 in all-another and most holy feminine base number.

In the macrocosm, Plato adopted the decussate cross in space (the X) as the second god who impressed himself on the universe in the form of the cross and astronomically this is represented in the Southern Cross Constellation.

In the microcosm, the fact of Christ crucified on the cross is an ancient idea acted out in the mysteries of initiation for thousands of years prior to the birth of Christ.

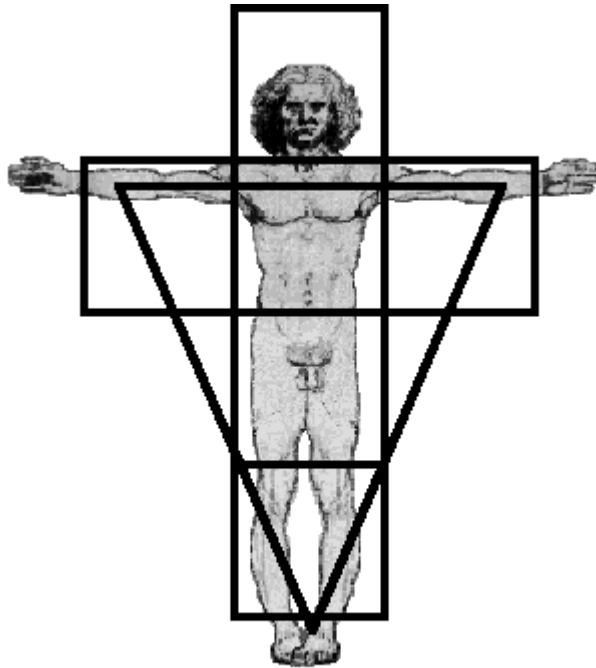

**Man crucified on cross
3 nails + 4 wounds = 7**

The first part of the mystery lay in the coffin. R. Steiner described the candidate for admission being placed in a coffin for three days and nights, during which time his astral body and ego traveled with his master on the astral plane. Upon being "raised" from the coffin, the candidate, after experiencing the spirit world, becomes a fully initiated adept. The druids used subterranean caves or temple crypts in lieu of the coffin. The coffin ritual is still preserved in the third degree of a master mason which still occurs thousands of times a year to this day. Even in black magic this ritual is preserved where the Haitian voo-doo priest drugs his candidate and places him in a coffin for three days, after which he is raised as a zombie slave. Whether placed in an underground crypt or coffin, the symbolism is in all ancient mysteries the same. The three days in the coffin for the candidate is correspondent to the three days Christ spent in the crypt after his crucifixion, both the candidate and Christ are raised or resurrected to a new spiritual life.

The second part of the mystery lies in the crucifixion on the cross as the tree of life. In the Egyptian mysteries, the initiation took place in the kings chamber of the Great Pyramid of Cheops. This room is built entirely of granite, well finished and finely jointed. Positional close to the west wall is a large rectangular granite sarcophagus so impressive that the original British surveyors Vyse and Penning remarked (1837) that, "the kings chambers is the principle apartment, and the security of the sarcophagus within it the great object for which the Great Pyramid was erected." So true, the other pyramids were for burying the dead, the Great Pyramid was for initiation of the living and the coming mystery of Golgatha.

The candidate who had passed all his former trials was attached (not nailed) to a wooden cross in the tau shape and afterwards placed in the sarcophagus for the three days during which time his spiritual ego traveled the spirit land. During the night of the approaching third day, the candidate in the sarcophagus was carried to a gallery where at dawn, he was raised to the glory of the rising sun (Osiris), addressing the sun spirit with a newborn spiritual life. The mystery of Christ, as the Solar logos, crucified on the cross and afterwards his resurrection from three days in the crypt now becomes clear. We know that Plato was initiated in the kings chamber and he is the source of the astronomical cross in space. Likewise, we know Moses and his master JETHRO were Egyptian initiates and they carried this symbolism into the Hebrew Messianic cycle so that the passion and death of Christ was "according to the scriptures" or more accurately "according to the Egyptian mysteries".

Thus, the mystery of the crucifixion dates back to the very establishment of the ancient mysteries where in the candidate becomes reborn after his crucifixion on the tree of life or tau cross. And, so Skinner shows, this mystery is written into the mathematical and geometric symbols of the cube unfolded.

3. INSIDE THE CUBE

The cube is everywhere the symbol for earth and matter. In the Qabalah we saw the fourth sephiroth Heseb represent the six dimensions of matter as a six-sided cube. In the Timaeus, Plato described the cube as the corpuscular element of earth and matter. However, there is one fundamental problem with the cube as representative of the building block of the manifested universe, Composed of six square faces, it is inherently unstable. As B. Fuller says, "Any polygon with more than three sides is unstable. Only the triangle is inherently stable. Any polyhedron bounded by polygonal sides with more than three sides is unstable. Only polyhedra bounded by triangular faces are inherently stable." This can be shown in Plat no. 10 . Therefore, the triangular face of the tetrahedron is more stable than the square face of a cube.

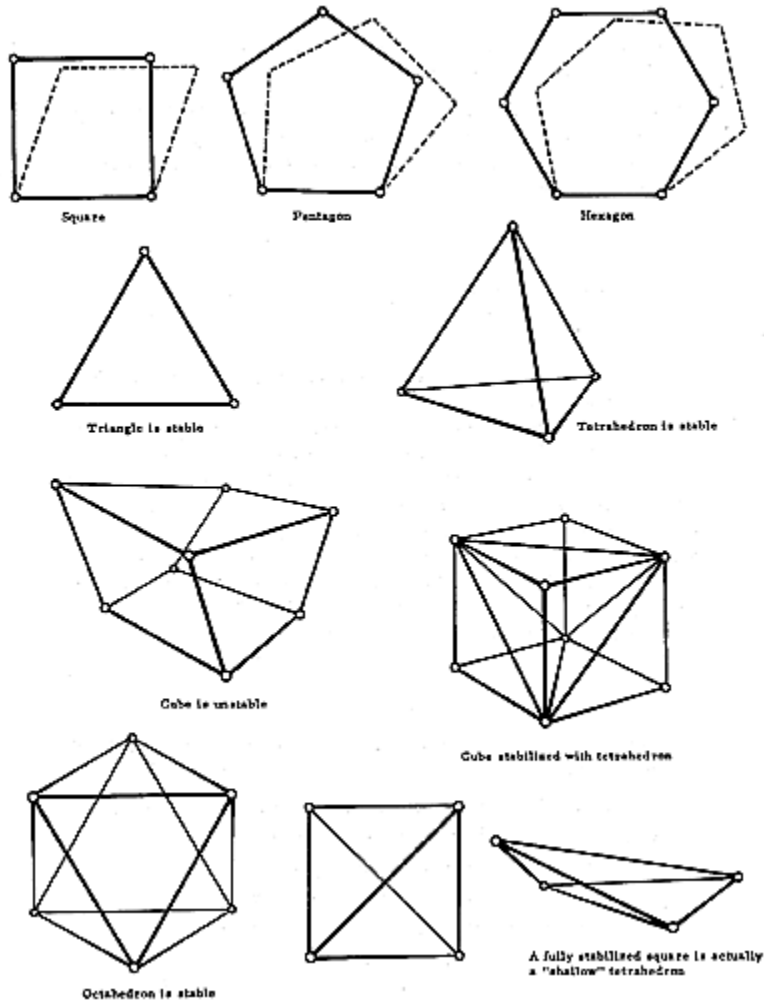

From the Law of Three, we saw that the tetrahedron is the first subdivision of the universe and also the first primary structure. This is not inconsistent with the cube as primary elements of earth-matter, since the cube can be constructed of tetrahedra.

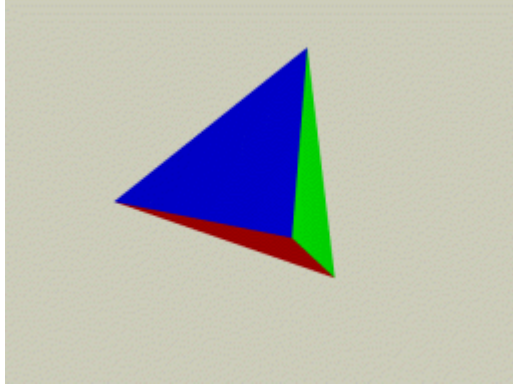

All polyhedra may be subdivided into comparable tetrahedra. Every cube contains two tetrahedra as shown here

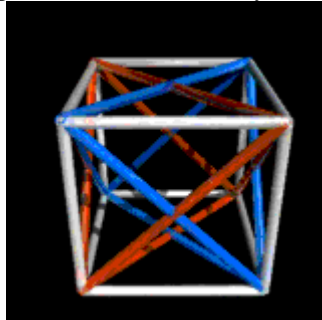

and here

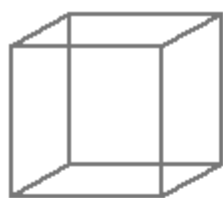

CUBE □

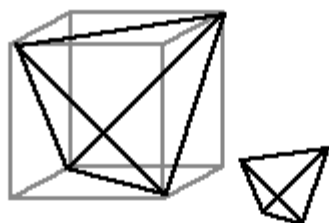

POSITIVE TETRA ⊕

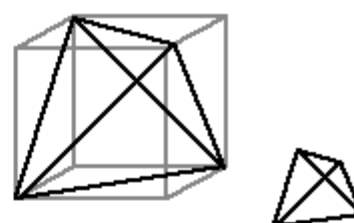

NEGATIVE TETRA ⊖

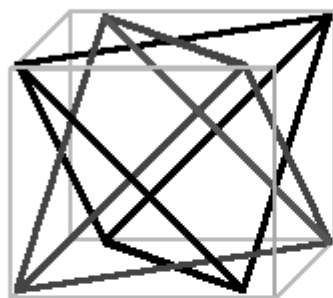

STABLE CUBE ⊗
DUO-TET CUBE

CONGRUENT CENTERS OF GRAVITY
WITH CUBE AND TWO TETRA

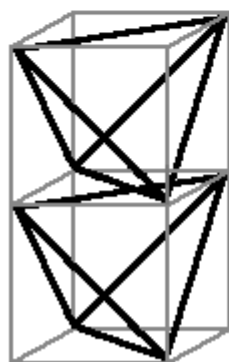

**STACKING OF
POSITIVE TETRA**

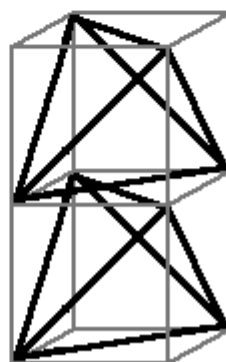

**STACKING OF
NEGATIVE TETRA**

without the cube edges here .

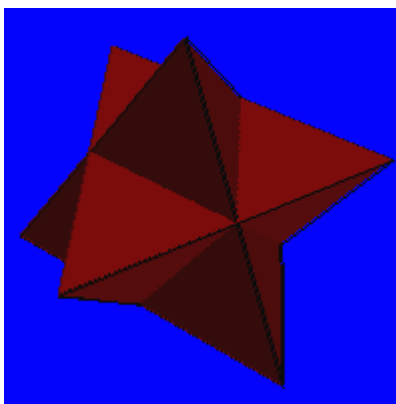

This is accomplished by inscribing on every square face a diagonal which becomes one of the six edges on the tetrahedra. A cube stabilized by one tetrahedra has each of six square faces inscribed by a diagonal. A cube stabilized by two tetrahedra, has each of six square faces inscribed by two diagonals. Obviously, the latter cube with two inscribed tetrahedra is the most stable.

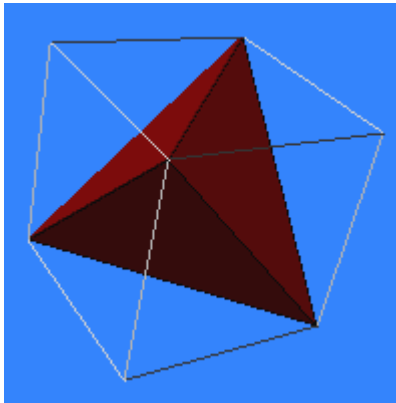

B. Fuller called the alternate pair of tetrahedra, "symmetrically juxtaposed positive and negative " whose centers of volume are congruent with one another and congruent with the center volume of the cube. Thus, every cube can be stabilized with a positive set of six tetra diagonals and a negative set of six tetra diagonals. It is possible to stack cubes in one column containing only positive tetra and a separate column containing only negative tetra. In conclusion, we have solved the problem of the unstable cube as representative of earth=matter by inserting into the cube either a positive tetra, a negative tetra or both. Thus, our cube unfolded should be re-drawn to show the alternating pair of tetrahedrons inside it as shown above .

Considering the cube as the platonic element of earth-matter with two tetra inside it, some interesting correspondences occur.

4.SYNERGETIC CUBE UNFOLDED

SYNERGETIC CUBE UNFOLDED

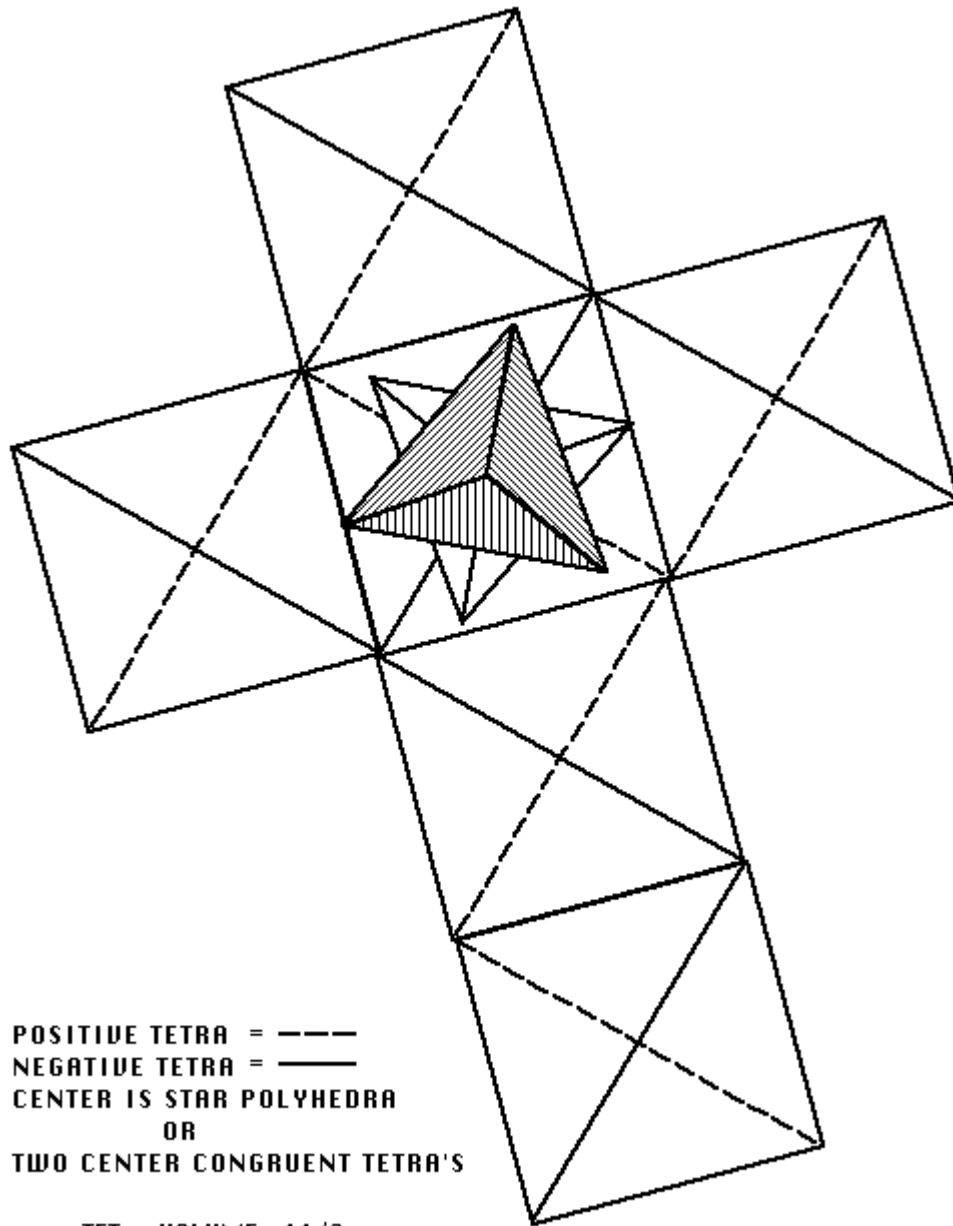

POSITIVE TETRA = - - - -
NEGATIVE TETRA = ————
CENTER IS STAR POLYHEDRA
OR
TWO CENTER CONGRUENT TETRA'S

TET - VOLUME = 11/2
CUBE = 3
HOURLASS = 1 1/2

First, J.R. Skinner's model of the cube unfolded needs to be reworked. His mathematical and geometrical key for the symbolic coordinating unit of measure discussed on the cube unfolded is based upon, "the figure of the cube unfolded, in connection with the CIRCLE, WHOSE MEASURE IS TAKEN OFF ONTO THE EDGES OF THE CUBE".

His mistake is using the "edge length" of a cube as the primary unit of measure as opposed to using the "diagonal length" of the cube as the primary unit.

From the Law of Three, we observed that the tetrahedron is the primary structural unit of cosmos, and not the cube. Therefore, the edge length of the tetrahedron should also be the primary unit of measure for a coordinating geometry of cosmos. Otherwise, one must always use a conversion factor representing the difference between the edge length

of the cube edge as the edge length of the tetra. This is a problem of all modern science which uses the three-dimensional cube as primary unit of measure. For example, volume should be measured not as cubic volume but as tetra volume which is three times more efficient. Also, geometry should not use the 90 degree coordination of the cube but should use the 60 degree coordination of the tetra.

The edge length of the tetra is contained in the cube as the length of the cube face diagonal. Therefore, in the Skinner model of the cube unfolded, the circle or sphere as head of man, should be measured off the diagonal length of the cube and not the edge length of the cube.

Using this new key, synergetic geometry measurement of unity commences with the tetra-edge as prime vector.

Unity is not taken from the cube edge, but from one of the two tetra-edge diagonals that structure the cube.

MENSURAL UNITY shows the cube structured by the tetra whose unit vector diameter value is two, and the cube edge lengths value is the square root of two, a difference of two - 1.4142 = 0.5858.

MENSURAL UNITY

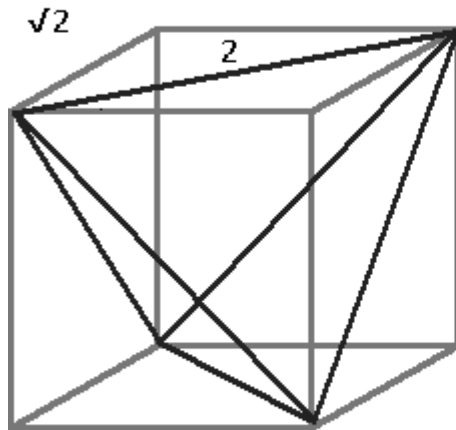

Edge length of cube is not economical; diagonal of cube equals edge length of tetra.

Edge length of tetra is PRIMARY unit of measurement in solid geometry and nature

$$\sqrt{2} = 1.4142$$

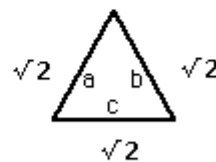

For example, the conventional XYZ 90 degrees coordinate volume for a sphere of radius one is 4.1888. To convert that cube edge length value to a sphere whose diameter is equal to the diagonal or tetra-edge length we must multiply by the above mentioned conversion factor of 1.0606. The result for a sphere volume with tetra-edge length is 4.4429, a difference of 0.2541 primary units of measure.

Second, let's call the Skinner cube now containing two center congruent tetrahedron the " Synergetic Cube Unfolded "

Reflecting back on the Law of Three and the upper holy triad of the Quabalah, we saw how the cosmos was divided into the manifest and un-manifest worlds. The unmanifest world showed God as trinity in unity in all ancient wisdom-religion systems. God as trinity also related to the Law of Three as representative of the three forces of active - passive - neutralizing (from Madame HPB and Gurdjieff) and positive - negative - resulting (from B. Fuller).

Taking the volume of the tetra as unity as one, the volume of a tetra-edge length cube is three. The correspondence follows. Contained within the manifest world as cube is the unmanifest world of Deity as three in one unity. Contained within the synergetic cube unfolded, is a positive tetra representing the positive or active face in nature and a negative tetra representing the negative or passive force in nature. A cube stabilized by two tetra is not full in volume, since the cube volume is three and two tetra volume is two. All that remains as space volume in the stabilized cube is represented by the third force as neutralizing - resulting and the holy ghost. The active - passive forces act in space and the resultant of their actions is reflected in form in the surrounding one third remaining volume of the cube.

Thus, the synergetic cube contains within itself the Law of Three in several forms. First, a cube with no tetra enclosed. Second, a cube with one positive tetra, which can be separately stacked. Third, a cube with one negative

tetra, which also can be stacked. Fourth, a cube with both positive and negative tetra enclosed within the space of the third force. Thus, a total of four variations in the manifest world.

This has great possibilities as a building block or element in the manifest world the cube can exist independently and be stacked as positively charged, or negatively charged or as a balanced charge of neutral. We see this in the atomic world as independently charged bodies of electrons, protons, and positrons empty cubes as neutrinos and neutrons and atoms. On the sub-atomic scale our own script could be as follows:

Empty Cube----- Neutrino----- (0)

Positive Cube----- Positron----- (+)

Negative Cube----- Electron----- (-)

Synergetic Cube ----- Atom (Duo-Tet Cube) (2 interpenetrating triangles)

Stating that the empty space within the synergetic cube represents the third or neutralizing force of the holy ghost is a sort of leap of faith and further explanation is required. This empty space shall be called (after Fuller) the "complementation domain". A cube has a tetra-volume of three and two tetrahedrons have a volume of two. But the remaining complementation domain of the holy ghost is not the remainder of one, because the combined two tetra share a combined common center with the cube center: shared common space which must be less than two volume units. HourGlass , Holy Spirit Plat



POSITIVE TETRA

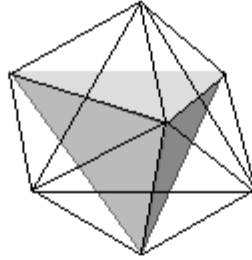

A.



NEGATIVE TETRA

A : Duo-Tet Cube with 1 Positive and 1 Negative Tetrahedron Volume = 3

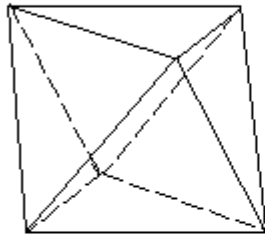

B.

B : Octahedron Volume = 4

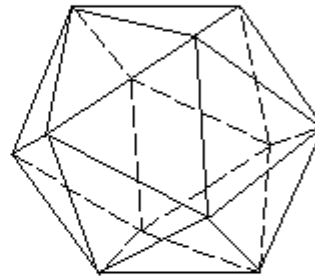

C.

C : Icosahedron Volume = 18.51

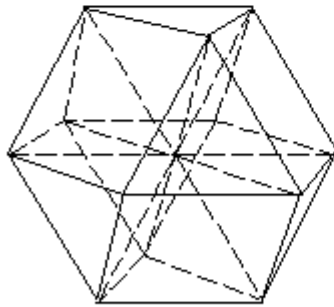

D.

D : Cuboctahedron Volume = 20

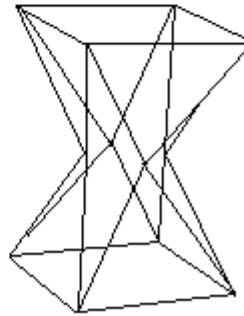

E.

**E: Hourglass Polyhedron = Volume 1 1/2
(Volume D minus Volume C + 1 1/2)**

shows a positive tetra on one-side, a negative tetra on one side and a combined duo-tet in the middle, the internal, trussing of the duo-tet allows their equi-inter-distanced vertexes to define a stable eight cornered cube. The exterior shape of the duo-tet star shaped polyhedron defines the last figure called an hourglass polyhedron. The cube is tetra volume three and within it is 1 tetra volumes of substance (the hourglass polyhedron) and 1 volumes of "complementation domain" within the eight vertexes of the cube. The over all cubic domain consists of three tetra volumes: one outside out (1 1/2) and one inside out (1 1/2).

Thus the space or domain of the third force is 1 tetra volumes and the form of the positive - negative tetra in the hourglass form is also 1 tetra volumes. This volume of 1 has an important correspondence in the Law of Twelve where we observed the cuboctahedron volume of twenty (annihilated) reduced to the icosahedron volume of 18, when the nuclear sphere was removed a remainder volume of 1.

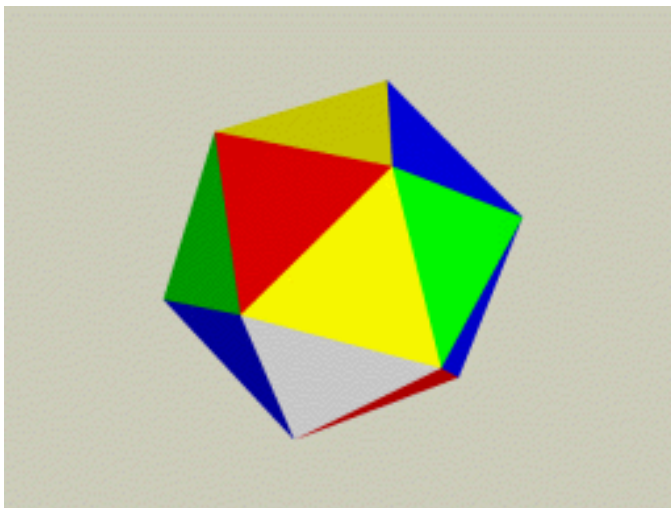
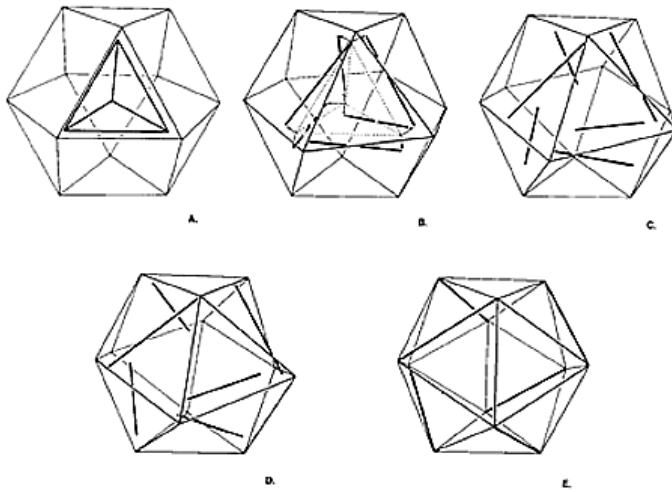
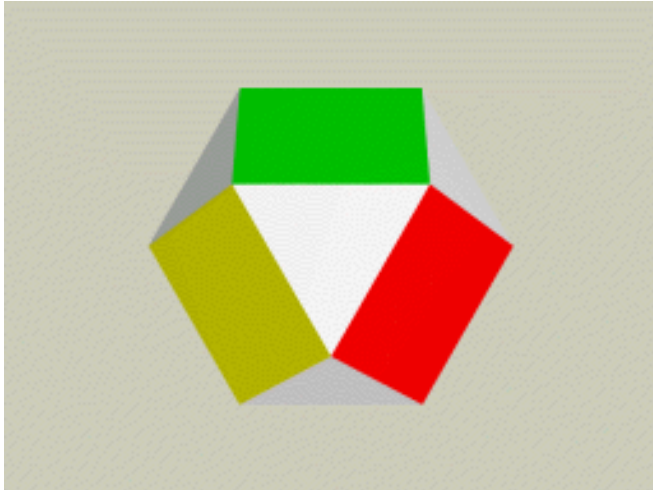

As a postscript on the complementation domain of the holy ghost, I recently read the following from the work of Kepler who also recognized the space of the third force:

"Thus for example in the cosmos there are three things at rest, the sun, the fixed stars and the intermedium, and all else is movement; and so in the one God are Father, Son and Holy Spirit. The sphere represents the trinity: the Father is the center, the Son the surface, and the Holy Spirit the uniformity of the distance from center to surface(the radius);...A certain image of the zodiac and of the whole firmament is imprinted by God in the soul of the earth."

Now that the space or complementation domain of the third force (holy ghost) has been established as one and one-half tetra-volumes, what is the action or non-action of the third force within this domain?

We observed in the Law of Seven the symbolic representation of the triangle wholly within the cube as the synthesis of the lower quaternary with the upper triad.

This correspondence can be now brought forward in the concept of the rotation of a triangle in a cube or the holy ghost as wave (spirit) propagation model.

Ours is a universe of radiation in harmonic vibratory motion. Starting with a primary vibrating unit called a photon, the process of emission and movement of these units is called radiation. The space-time ratio of the vibration is the frequency of the radiation and the speed of the outward progression of the speed of radiation is the speed of light. The combination of a vibratory motion and a linear motion perpendicular to the line of vibration results in a path which has the form of a sine curve or wave.

B. Fuller has demonstrated that wave propagation model wave propagation action is cyclically generated by a cube with a triangle rotating in it Synergetics.

WAVE PROPAGATION IS CYCLICALLY GENERATED BY A CUBE WITH A TRIANGLE ROTATING INSIDE IT

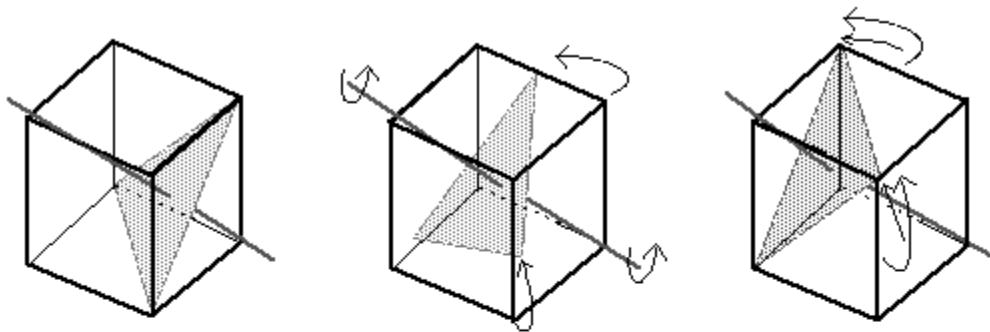

Each diagonal of the cube face is a tetra edge.

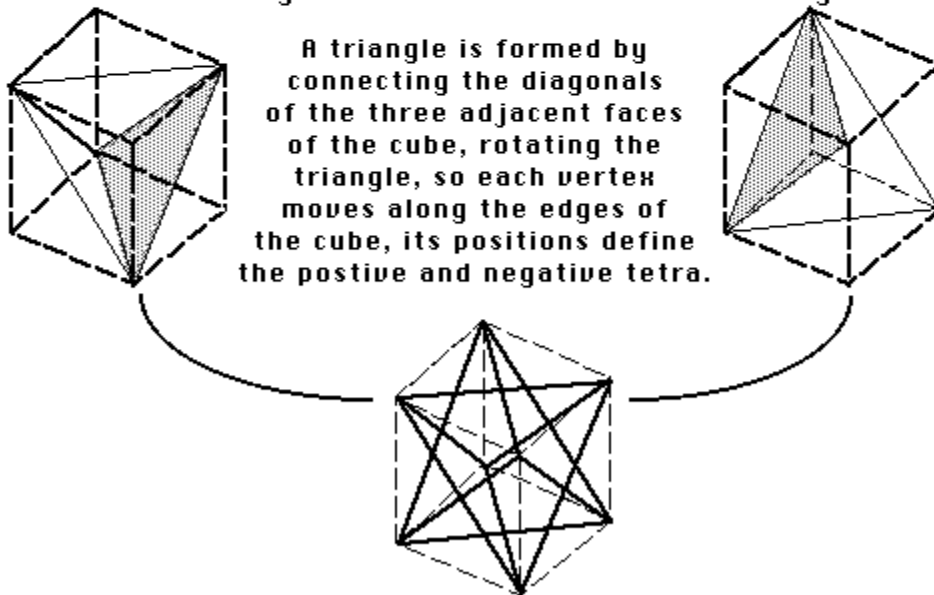

A triangle is formed by connecting the diagonals of the three adjacent faces of the cube, rotating the triangle, so each vertex moves along the edges of the cube, its positions define the positive and negative tetra.

Each wave cycle is six cube edge motions.

As shown in Plat No. , the triangle formed by connecting the diagonals of three adjacent faces of the cube is the face of the tetrahedron within the cube. As the triangle rotates in the cube, so that its vertexes move along the edges of the cube, it goes from being congruent with the positive tetrahedron to being congruent with the negative tetrahedron. In one complete cycle, there are six vector wave moves. The half or sine curve is formed when we consider the cube, not as a figure of straight lines, but as an oscillating system in which, as the triangles rotate, their

corners describe arcs which convert the cube's 12 edges from straight lines to 12 arcs which produce a pulsating, swollen spherical cube.

Our empty cube is static and forms a rotational base from which the triangles in tetrahedrons can enter and rotate. As the triangles of the tetrahedron rotate within the cube, the static form of the empty cube oscillates to a swollen dynamic condition, from the potential to the radiant. As the triangle rotates, what was once an empty static space, pulsates into a spherical cube as the edges of the cube become the six wave linear (sine curve) diagonals of the tetrahedron.

The electromagnetic sine curve or wave is the six fold path of the photon along the diagonals of the cube faces. The cube face is surface area and the total available energy of a system is related to its surface area, involving the second power of the radius ($E=MC^2$). The tetrahedron has the most surface area with the least volume of any symmetrical polyhedra. Positive and negative electromagnetic energy is generated as the rotating triangle passes through the common energy centers of the two tetrahedrons and delivers the opposite electromagnetic charge from the base of one tetra to the other tetra. This rapid shuttle of the rotating triangle back and forth between oppositely charged tetras generates electromagnetic energy which is transferred to the faces of the cube.

In conclusion, within the empty space or complementation domain of the third force or Holy Ghost (Spirit), there is an abundance of activity. The rotation of the triangle within the cube with six vector wave moves per cycle, alternately expands from a static cube to a spherical cube and contracts back to a static tetrahedron, which tetra is alternatively positive and negative, propagating electromagnetic waves reflected on the faces of the cube.

SYMBOLS OF TEN

1. Pythagoras

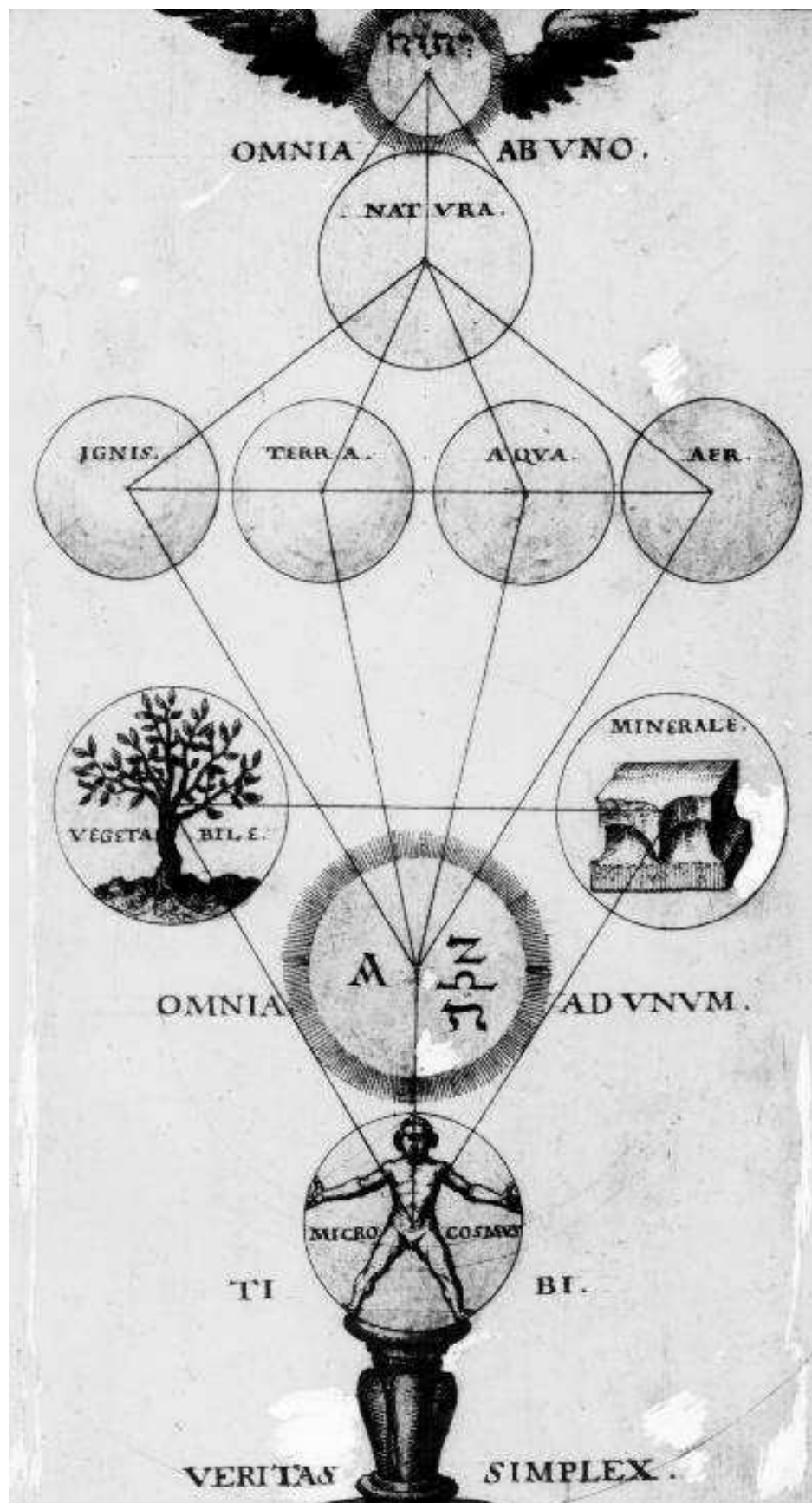

The law of three added to the law of seven obviously gives ten. Probably the most ancient (alchemical) symbol of these two fundamental laws of Cosmos combined as the Decad is the tetractys, first introduced by Pythagoras.

Of the Numbers that the Ancients Consecrated to Their Gods and Ascribed to the Elements and Planets
The PYTHAGOREANS dedicated certain Numbers sacred to the Elements and heavenly bodies. To the Air and Octonary, to the Fire a Tetragon, to the Earth a Senary, to the Water a Duodenary number they assigned. Moreover, they ascribed unity to the Sun, because he is the only King of the stars, wherein God placed his Tabernacle. They ascribed the same to Jupiter, who was the father and head of the Gods, as unity is the beginning and parent of Numbers.

Duality is given to the Moon, which is the second luminary, and figures out the Soul of the World, and is called June, because between her and unity there is the first conjunction and alike concord. It is also given to Saturn and Mars, the two Infortunes with Astrologers.

The Number Three agrees with Jupiter, the Sun and Venus, the three fortunes, it is also deputed to Vesta, Hecate and Diana. This triad is therefore dedicated to this virgin, which they say is powerful both in heaven and hell.

Four or the Quaternary Number belongs to the Sun who by that number constitutes the cardinal points of heaven and the seasons or times of the year, it is also deputed to Cillenius which was the only quadrate God esteemed.

Five or a Quinary is assigned to Mercury from one parity and one imparity, as it is manifest from either sex, masculine or feminine. Also it is attributed to the heavenly world, which above the four elements is the fifth under another form.

A Senary pertains to Venus and Jupiter, which is made up of a triad led by a dyad, which number Pythagoras is accommodated to generation and marriage.

Septenary, a number of rest, belongs to Saturn. The same number concerns the Moon's motion and light. It is assigned to Minerva who hath no generation, also to Pallas that virago, because it consists of numbers as well masculine as feminine. Plutarch gives this number to Apollo.

The Eighth number belongs to Jupiter, sacred to Justice and it is dedicated to Vulcan. It is attributed to Cybele, the Mother of the Gods, to whom every Cube is given. Plutarch assigned that number to Bacchus or Dionysius, who was born in the eighth month; because others born in the eighth month died, they constituted that number to Saturn and the Parcae.

The number Nine belongs to the Moon, the last receptacle of all celestial influences and virtues, no less than if it were dedicated to the nine muses, as also to Mars from whom is the end of all things.

The tenth number is circular because Monas or Unity belongs to the Sun. Also it is assigned to June. In like manner the Twelfth number, because the Sun goes through the 12 signs in 12 months. This number is given to the world, to the heaven, and to the Sun. But the eleventh number because it is semicircular is attributed to the Moon and deputed also to Neptune.

(From ANGEL MAGIC, British Museum)

Without narrating a life of Pythagoras, there are two important things to remember about him. First Pythagoras was an initiate of all the ancient mysteries. This fact is reflected first hand in *The Life of Pythagoras* by Iamblichus (B.250 AD). After receiving all the available teachings of ancient Greece and presumably initiated into the Eleusinian mysteries and after consulting all the Greek oracles, he travelled to Egypt on the advice of his teacher, Thales. Here, he was initiated into the mysteries of Isis at the hands of priests at Memphis and Thebes. Like his future successor Plato, he was placed on the Tau wooden cross and raised on the third day from the granite sarcophagus in the Kings chamber. Later, he travelled to Phoenicia and Syria where he was initiated into all the mysteries of Adonis at Byblos and Tyre. Taken captive by the soldiers of Cambyses, he was carried off to Babylon, where he was later initiated by the magi in the Chaldean lore of astronomy and geometry. Although Iamblichus does not mention this sojourn, he is said to have travelled through Media and Persia into India where he studied for several years as a pupil of the Brahmin priests of Elephanta and Ellora. The name of Pythagoras is still preserved in Brahmin records as Yavancharya, the Ionian teacher.

Pythagoras was said by all ancient biographers to be the incarnated son of Apollo and Pythais and Friend of Zeus. He certainly taught of the incarnation of the soul, which was exoterically confused with the transmigration theory later attributed to him. Fragments from the Doxographers say " He said that the soul is immortal, and that it changes from one body to another; so he was wont to say that he himself had been born before the Trojan war as Aethalides, and at the time of the Trojan war as Euphorbus, and after that as Hermontimus of Samos, then as Pyrrhos of Delos, fifth as Pythagoras." His father built a temple to Apollo, inscribed to Pythais and his birth was predicted by the Pythian Oracle. Certainly, Pythagoras was a messenger from the Gods and his wisdom a synthesis of all then

existing mystery schools. We really do not see another such an eclectic esoteric person until the life of Apollonius of Tyana, a contemporary of Christ.

Second, as a great initiate, Pythagoras was part of the messianic cycle leading to the birth of Christ. R. Steiner has spoken on numerous occasions that the messianic cycle preparing for the birth of Christ was more than the scripture of the Jewish-Hebrew tradition dating from Moses and the Exodus. In fact, all the ancient mystery schools contributed through their mystery wisdom and rites of initiation to the birth, life and death of Christ as Golgatha. A glimpse of this secret knowledge was discussed supra when it was related how the Egyptian initiation in the King's chamber enacted the drama of Christ as nailed to the Tau cross, death in the crypt for three days and resurrection to a new spiritual life.

Another glimpse of this secret key known to ancient mystery wisdom has been revealed by Steiner in a series of lectures on the birth of the Christ child as follows.

About 100 years prior to the birth of the Christ child, an incarnation of the Gautama Buddha was born in the Holy Land named Jesus Ben (son of) Pandira. He became the founder of the Essence religions sect, which later taught the Christ child after he left the temple at age twelve. His purpose was to prepare the world for the birth of Christ. He had a pupil named Matthew whose name passed over to other pupils and the Matthew Synoptic gospel was written in the form of rituals taken from the ancient mysteries by the first Matthew. (This is why the Matthew gospel was first written in Hebrew and not Greek as translated by St. Jerome.)

The good Madame H.P.B. confirms this historical event in her paper entitled, *The Esoteric Character of the Gospels*, referring to the Rabbinical tradition in the Babylonian Gemara called *Sepher Toldus Jeshu* about Jesus being the son of one named Pandira, and having lived a century earlier than the Christian era, namely, during the reign of the Jewish King Alexander Jannaeus and his wife Salome who reigned from 106 to 79 B.C. "accused by the Jews of having stolen from the Holy of Holies the Incommunicable name, Jehoshua (Greek for Jesus) was put to death by the Sanhedrin at Lud. He was stoned and then crucified on a tree, on the eve of Passover. The narrative is ascribed to the Talmudistic authors."

In the Bible, Jesus descended from the House of David. However, two Jesus children were born, one from the Solomon line of the House of David and one from the Nathan line of the House of David. The individuality who was the Solomon Jesus child was an incarnation of Zarathustra; the founder of the cultural epoch of Persia and the mystery school of the Magi. At age twelve, through an occult process, the individuality of Zarathustra forsook the body of the Solomon Jesus child and went over to the etheric body of the Nathan Jesus child. The body of the Nathan Jesus child was prepared by and contained the astral body of the Gautama Buddha. After leaving the temple at age twelve, the now Jesus of Nazareth child, bearing the etheric body of Zarathustra and the astral body of Buddha, wandered the near east visiting the sites of the ancient mysteries, including the Mithras cult. I say the now Jesus of Nazareth because after age twelve, the mother of the Nathan Jesus boy died and the father of the Solomon Jesus boy died. The surviving spouses married and the brothers and sisters of the Solomon child became part of his family, now living in Nazareth.

Later, Jesus of Nazareth spent many years with the Essene sect, where he met John the Baptist. At the baptism of Jesus in the Jordan, the ego of Christ as solar logos descended upon him completing the four bodies of his lower quaternary.

Knowing the Zarathustra connection in the Messianic cycle, the Pythagorean connection can be explained. Porphyry (b.233 A.D.) the Greek neoplatonic philosopher in writing on the life of Pythagoras says that, "In Babylon he associated himself with the other Chaldeans, especially attaching himself to Zaratus (Zarathustra), by whom he was purified from the pollution of his past life...and here, Pythagoras acquired the greater part of his wisdom." The name Zarathustra as well as the names of other ancient savants like Mani, Manu, Hermes, Rishi, etc. once stood for an original person, but in the mystery tradition, the students take the name of the teacher, so that after several generations, the name becomes generic representing an esoteric stream of knowledge. This is why modern scholars can never exactly date the life and death of the great adepts.

Steiner says that Zarathustra incarnated as Zaratus (as per Porphyry) or Nazarathes, the teacher of Pythagoras in Babylon. Here, in Babylon, Pythagoras became initiated in the Messianic cycle as did the Jews of the Babylonian captivity. In subsequent incarnations, Pythagoras was reborn as one of the three Magi who visited the crib of Jesus in Bethlehem and later became a disciple of Jesus of Nazareth.

The good Madame H.P.B. also confirms the Zarathustra connection in the Messianic cycle. The first three chapters of Vol II, *ISIS UNVEILED* is dedicated to the proposition that the appellation of Jesus of Nazareth was so called not because he came from his father's residence at Nazareth but because Jesus was an initiated member of the esoteric mystery sect called the NAZARIA, the healers.

To support this theory, she states that the Nazirite sect existed long before the Laws of Moses and originated among peoples most inimical to the "chosen" ones of Israel, the people of Galilee, where was built a city called

Nazara, the present Masra. Here, and in the caves of Bethlehem, the Nazra held their sacred mystery rites of initiation. In fact, history shows the first Christian sects to be either the Ebionites or the Essenes, the later being Therapeutae healers, of which the Nazarenes were a dissenting branch which included John the Baptist and his followers.

The Madame says that the Nazara of Galilee were first Pythagoreans and after conversion to the Buddhist monastic life, became the sect known as Essenes. The word "Nazar" means to vow or consecrate oneself to the service of God. As a noun it was an emblem of such dedication, and for this reason Joseph, Ezra, Sampson and Samuel were called Nazars. She concludes that the Zar-adas of the Pythagorean biographer Porphyry was the head or Nazar of the Babylonian mystery school in which Pythagoras was initiated. She, like Steiner, recognizes that the word Zoroaster becomes a generic term since the followers of the original Zoroaster called themselves as disciples by the same name.

Thus, some historians refer to Pythagoras Babylonian teacher as Nazarathus (by Clement of Alexandria) or Zaratus or Zaradas or Narazad. These are but changes of idioms for different cultures. The key is that they are all derivatives of the word Nazar which establishes a direct link with Pythagoras, his teacher Zarathustra at Babylon and the Essene sect which instructed Jesus prior to his leaving this sect with John the Baptist.

In addition, other clues emerge with the Nazarene connection with Christ. For example, the Nazarene priests and initiates were circumcised. All sect members were baptized in the Jordan River and before and after baptism, they had to fast. The gospels tell us that Jesus fasted for forty days after his baptism in the Jordan by John. The Nazarenes wore their hair long, like Sampson and Elijah, the prophet. Both John the Baptist and Jesus are described in the gospels as wearing very long hair. Lastly, Jesus is described as wearing a log white garment without any seams. This is the same description given by Josephus of Nazarene priests and the Buddhist Essenes.

In conclusion, Pythagoras, the great initiate, carried forth his occult wisdom, hand in hand with Zarathustra, in the ancient mysteries preparation of the Messianic cycle.

2. THE TETRACTYS and the SQUARE of FOUR

By way of introduction, the symbol of "The tetraktys and the square of Four" is best described by Rene Guenon in his 1937 published article of the same name which is set forth entirely because so instructive and not a wasted word. " We have often had occasion to allude to the Pythagorean tetraktys with its numerical formula $1+2+3+4=10$, showing the relationship that unites the number 10 directly with the number 4. the quite exceptional importance which the Pythagoreans attached to the Tetraktys is well known and it can be measured especially by the fact that they swore by the "holy tetraktys."

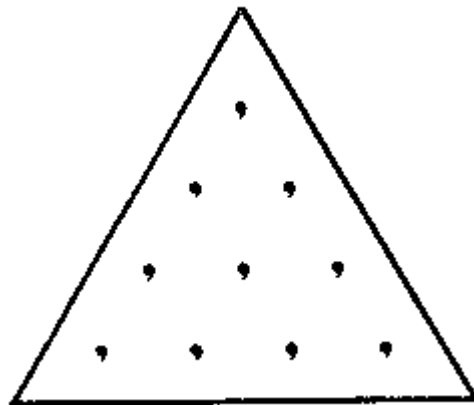

THE TETRACTYS.

It is no doubt less well known that they also had another formula for their oaths, namely, "by the square of four"; between the two formulas there is an obvious relationship; for the number 4 is their common base. This implies, among other things, that the Pythagorean doctrine had to be put forward in a mode that was more "cosmological than purely metaphysical", nor is that an exceptional case when Western traditions are concerned, for we have already had cause to make an analogous remark about Hermetism. The reason for this deduction, which may seem strange at first to those who are unaccustomed to the use of numerical symbolism, is that the quaternary is always and everywhere considered as the number of universal manifestation. In this respect, it therefore marks the very starting point of cosmology, while the numbers that precede it, 1, 2 and 3, are strictly related to ontology. The particular emphasis on the quaternary ipso facto corresponds to the cosmological perspective itself.

At the beginning of the *Rasa il Ikhwan as-Safa*, the four terms of the fundamental quaternary are enumerated as follows: 1-the principle, which is designated as *al-Bari*, the creator (which indicates that it is not the supreme principle, but only being, inasmuch as it is the first principle of manifestation which is, in fact, metaphysical Unity); 2-the universal Spirit; 3-the universal soul; and 4-the primordial Hyle. We will not develop just now the different points of view from which these terms can be understood; they could be said, for example, to correspond to the four worlds of the Hebrew Kabbala, which also have their exact equivalents in Islamic esoterism. What concerns us for the moment is that the quaternary thus constituted is held to be presupposed by manifestation, in the sense that the presence of all its terms is necessary for complete development of the possibilities which manifestation comprises; and this moreover is said to be why, in the order of manifested things, the mark of the quaternary, we might say its "signature", is always especially noticeably-whence, for example, the 4 elements (ether is not being counted here, for it is a question only of the differentiated elements), the four cardinal points (or the 4 regions of space which correspond to them, with the 4 pillars of the world), the 4 phases into which each cycle is naturally divided (the ages of human life, the seasons in the yearly cycle, the lunar phases in the monthly cycle, etc.) and so on. Any number of applications of the quaternary are there, all interconnected moreover by rigorous analogical correspondances, for basically they are just so many more or less specialized aspects of one same general schema of manifestation. This schema, in its geometric form, is one of the most widespread symbols, one of those which are truly common to all traditions: it is the circle divided into 4 equal parts by a cross formed from 2 diameters at right angles; and it can be noted at once that this figure expresses precisely the relationship between the quaternary and the denary, as does the numerical formula we recalled at the beginning. In fact the quaternary is represented geometrically in its static aspect by the square, but in its dynamic aspect, as here, by the cross; and the cross, when it turns around its own center, engenders the circumference which, with the center, represents the denary which itself is the complete numerical cycle. This is what is called the "circling of the square", the geometric representation of which is represented arithmetically by the formula $1+2+3+4=10$. Inversely, the Hermetic problem of squaring the circle (an expression so often misunderstood) is nothing other what is represented by the fourfold division of the circle implicit from the two diameters at right angles. This will be expressed numerically by the same formula, but written inversely: $10=1+2+3+4$, to show that all the development of manifestation is thus brought back to the fundamental quaternary.

Let us now return to the relationship between the Tetraktys and the square of 4: the numbers 10 and 16 have the same rank, namely the fourth, in the two series of triangular numbers and square numbers respectively. The triangular numbers, of course, are those numbers obtained by adding the consecutive whole numbers from unity to each of the successive terms of the series. Unity itself is the first triangular number, as it is also the first square number; for being the principle and the origin of the series of whole numbers it must also be the principle and origin of all the other series that are derived from it. The second triangular number is $1+2=3$, which shows, moreover, that once unity has produced the binary by its own polarisation, the immediate result is the ternary; and the geometric representation of this is obvious: 1 corresponds to the summit of the triangle; 2 to the extremities of the base, and the triangle itself taken as a whole is naturally the figure of the number 3. If we then consider the three terms of the ternary as having an independent existence, this sum gives the third triangular number: $1+2+3=6$. This senary number, being the double of the ternary, can be said to imply a new ternary which is a reflection of the first, as in the well known symbol of the "seal of Solomon". Continuing the series, the fourth triangular number is: $1+2+3+4=10$, namely the Tetraktys; and one sees by this, that the quaternary in a sense contains all the numbers because it contains the denary-whence the formula of the TOA-TE-KING, one has produced two, two has produced three and three has produced all the numbers, which amount to saying once again that all manifestation is as it were enveloped within the quaternary, or inversely, that the quaternary constitutes the whole basis of manifestation's integral development. The Tetraktys, as a triangular number, was naturally represented by a symbol which, taken as a whole, was of ternary form, each of its outer sides comprising 4 elements; and this symbol was comprised of 10 elements in all, represented by as many points, of which 9 were the perimeter of the triangle and one at its center. It will be noted that in this disposition, despite the difference of geometric forms, we have the equivalent of the already explained representation of the denary by the circle, as there also 1 corresponds to the center and 9 to the circumference. In this connection, that it is because 9 and not 10 is the number of the circumference, that its division is normally calculated in multiples of 9 (90 degrees for the quadrant and subsequently 360 degrees for the entire circumference) which is moreover directly related to the whole question of cyclic numbers.

The square of four is, geometrically, a square of which the sides contain 4 elements, like those of the already mentioned triangle. If we consider the sides themselves, as measured by the number of these elements, the result is that the sides of the triangle and those of the square will be equal. These 2 figures can be united by making the base of the triangle and the upper side of the square coincide as in the figure below and the whole thus obtained gives rise to the several other considerations that are likewise not without importance. first, if we consider only the triangle

and square as such, this combination is a geometrical figure of the septenary as this is the sum of the ternary and the quaternary: $3+4=7$. More precisely, and according to the actual arrangement of the figure, this septenary is formed from the union of an upper ternary and lower quaternary, which lends itself to various applications. In the correspondence of triangular and square numbers, the first must be related to a higher domain than the second, from which it can be inferred that in Pythagorean symbolism the Tetraktys must have had a function higher than that of the square of four; and in fact, all that is known of that symbolism would seem to indicate that this was indeed the case.

There is a point which is somewhat stranger and which, though it refers to a different traditional form certainly cannot be considered as a mere coincidence. The two numbers 10 and 16, contained respectively in the triangle and square, have 26 as their sum; and this number is the total numerical value of the letters forming the Hebrew Tetragrammaton, yodh, he, vau, he. (we will see this later) This division of the Tetraktys is perfectly normal and the correspondance of the two parts is again very significant; the Tetraktys is thus identified with the YODH in the triangle while the rest of the tetragrammaton is inscribed in the square placed beneath it.

On the other hand, the triangle and the square both contain four lines made up of points; and if only to call attention to the concordances of the different traditional sciences, that 4 lines made up of points are to be found in the diagrams of geomancy diagrams which by the quaternary combination of 1 and 2 are of the number of $16=4^2$; and geomancy, as the name indicates, stands in a special relationship to the earth which, according to the far Eastern tradition, is symbolized by the square.

Finally, if we consider the solid forms in three dimensional geometry that correspond to the plane figures in question here, the cube corresponds to the square, and the figure that corresponds to the triangle is the quadrangular pyramid with the upper face of the cube as its base. The whole forms what Masonic symbolism designates as the "pointed cubic stone" and which in the Hermetic tradition is considered to be a figure of the Philosopher's stone."

That being said by the snerdly master of traditional symbolism, I would only add that the 3-dimensional form of the triangle is the tetrahedron, not the pyramid and as Dr. Steiner recommends, when I say the 7 petitions of the Lord's Prayer, I visualize the seven sides of the above symbol as said supra about the 7 principles of man represented geometrically as our figure of the septenary.

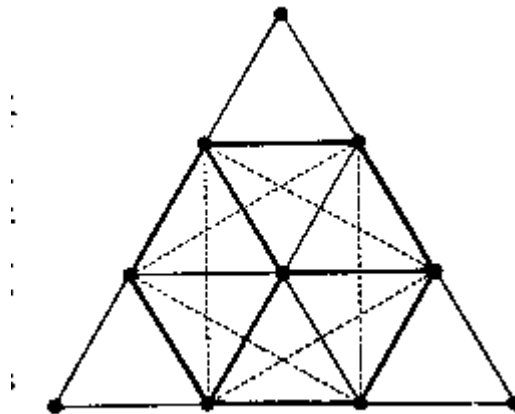

THE CUBE AND THE STAR.

3. MORE SYMBOLISM

Before studying more of the most ancient symbol of the Decad ,one must take the Pythagorean oath,



"By that pure, holy, four lettered name on high,
nature's eternal fountain and supply,
the parent of all souls that living be,
by him, with faith find oath, I swear to thee."

The first four numbers arranged in a triangle of ten points is the sacred tetractys .

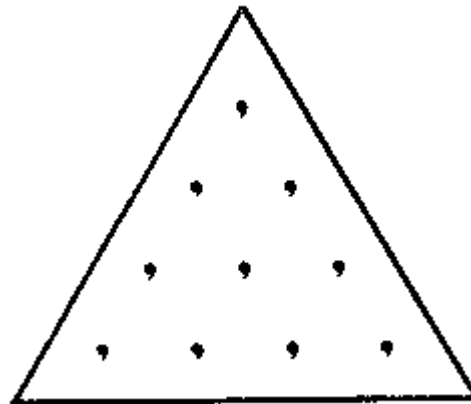

THE TETRACTYS.

The word is derived from "tetras" or four and also represents the quaternary.

The first quaternary is one of dimension and number related to form. The dot is the form of the number one. The line is the form of the number two. The plane is the form of the number three and the solid tetrahedron the form of the number four.

The second quaternary is that of music, the symphonic ratios which form the mathematical harmony of the musical scale: 1:2, the octave; 2:3, the perfect fifth; and 3:4, the perfect fourth.

The third quaternary is that of the ancient Platonic elements: one is fire; two is air; three is water and four is earth.

The fourth quaternary is that of the Platonic solids as they relate to the elements: fire is the tetrahedron; air is the octahedron; water is the icosahedron and earth is the cube. Together, we have,Robert Fludd's Pythagorean tetrad and as follows:

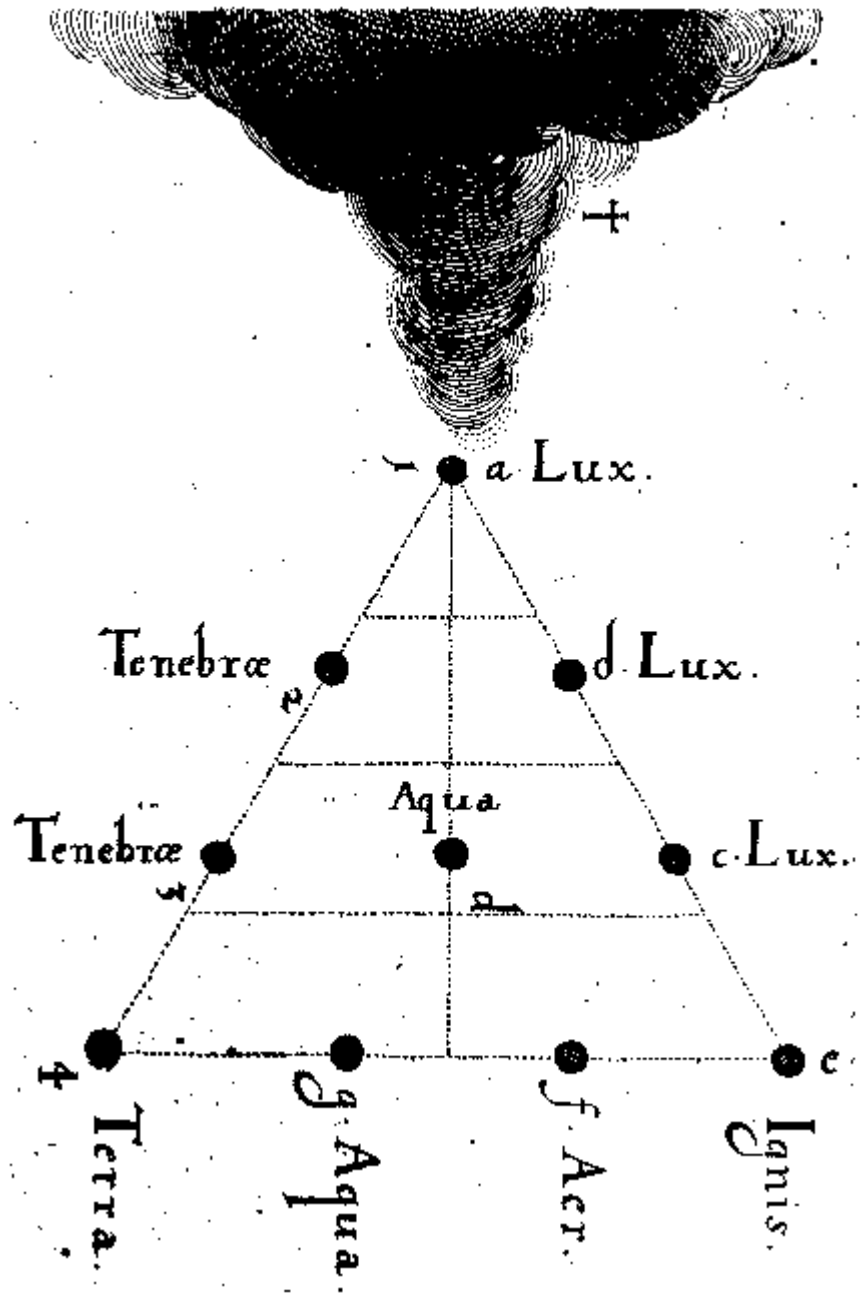

1. Point	tone	fire	tetra
2. Line	octave	air	octahedron
3. Plane	fifth	water	icosahedron
4. Solid	fourth	earth	cube

Another examination of the number of Tetraktys correspondences was by Theon of Symrna .

HOW MANY TETRAKTYS ARE THERE?

The importance of the quaternary is obtained by addition (that is to say 1 + 2 + 3 + 4) is great in music because all the consonances are found in it. But it is not only for this reason that all Pythagoreans hold it in highest esteem: it is also because it seems to outline the entire nature of the universe. It is for this reason that the formula of their oath was: "I swear by the one who has bestowed the Tetraktys to the coming generations, source of eternal nature, into our souls." The one who bestowed it was Pythagoras, and it has been said that the Tetraktys appears indeed to have been discovered by him.

The first quaternary is the one of which we've just spoken: it is formed by addition of the first four numbers. The second is formed by multiplication, of even and odd numbers, starting from unity. Of these numbers, unity is the first because, as we have said, it is the principle of all the even numbers, the odd numbers and of all the odd-even numbers, and its essence is simple. Next comes three numbers from the odd as well as the even series. They allow for the unification of odd and even because numbers are not only odd or even. For this reason, in multiplication, two quaternaries are taken, one even, the other odd; the even in double ratio, the first of the even numbers being 2 which comes from unity doubled; the odd in triple ratio, the first of the odd numbers being the number 3 which arise from unity being tripled, so that unity is odd and even simultaneously and belongs to both. The second number in the even and double [series] is 2 and in the odd and triple is 3. The third of the order of even numbers is 4, and in the odd series, 9. The fourth among the even numbers is 8, and among the odd numbers, 27.

The ratios of the most perfect consonances are found in these numbers; even the tone is included. However unity contains the principle of ratio, of limit and of point. The second numbers, 2 and 3, have the side ratio, being prime, incomposite numbers, and measured only by the unit, and are consequently linear numbers. The third terms, 4 and 9, have the power of the squared surface, being equally equal (that is to say square numbers). The fourth terms, 8 and 27, have the power of the cubic solid, being equally equal equally (that is to say, cubic numbers). In this way, by virtue of the numbers from this tetraktys, growth proceeds from the limit and the point up to the solid. In fact, after the limit and the point comes the side, then the surface and finally the solid. It is with these numbers that Plato, in the *Timaeus*, constitutes the [world] soul.* The last of these seven numbers is equal to the sum of all the preceding, as we have $1+2+3+4+8+9=n$.

There are then two quaternaries of numbers, one which is made by addition, the other by multiplication; and these quaternaries encompass the musical, geometric and arithmetic ratios of which the harmony of the universe is composed.

The third quaternary is that which, following the same proportion, embraces the nature of all magnitudes, for the place taken by unity, in the preceding quaternary, is that of the point in this one; and that of the numbers 2 and 3, having lateral (or linear) power, is here that of the line, through its double form, straight or circular, the straight line corresponding to the even number because it terminates at two points (the line and circle are given as examples here), and the circular to the odd, because it is composed of a single line without terminus.

And what, in the preceding quaternary, are the numbers 4 and 9, having the power of the surface, the two types of surface, the planar and the curved, are so (surface) in this one. Finally, what, in the preceding are the numbers 8 and 27, which have the power of the cube and of which one is even and the other odd, is constituted by the solid in this one. There are two kinds of solids, one with a curved surface, like the sphere or the cylinder, the other with a plane surface, such as the cube and the pyramid. This is the third tetraktys then, the one having the property of constituting any magnitude, through the point, the line, the surface and the solid.

The fourth quaternary is that of the simple bodies, fire, air, water and earth, and it offers the same proportion as the quaternary of numbers. The place occupied by unity in the quaternary of numbers is taken by fire in this one, air corresponds to the number 2, water to the number 3, earth to the number 4; such is indeed the nature of the elements according to their fineness or density, in such a way that fire is to air as 1 is to 2, to water as 1 is to 3, and to earth as 1 is to 4. The other relationships are also equal (that is to say, that air is to water as 2 is to 3, and so forth for the others).

The fifth quaternary is that of the shapes of simple bodies, for the pyramid is the figure of fire, the octahedron the figure of air, the icosahedron the figure of water and the cube the figure of earth.

The sixth is that of the created things, the seed being analogous to unity and the point. A growth in length is analogous to the number 2 and the line, and a growth in width is analogous to the number 3 and to the surface, and finally a growth in thickness is analogous to the number 4 and to the solid.

The seventh quaternary is that of societies. Man is principle and is thus unity. The family corresponds to the number 2, the village to the number 3 and the city to the number 4; for these are the elements which comprise the nation. All of these quaternaries are material and perceptible.

The eighth contains faculties by which we are able to form judgment on the preceding, and which are its intellectual part, namely: thought, science, opinion and feeling. And certainly thought, in its essence, must be assimilated to unity;

science is the number 2, because it is the science of all things; opinion is like the number 3, because it is something between science and ignorance; and finally feeling is like the number 4 because it is quadruple, the sense of touch being common to all, all the senses being motivated through contact.

The ninth quaternary is that which composes the living things, body and soul, the soul having three parts, the rational, the emotional and the willful; the fourth part is the body in which the soul resides

The tenth quaternary is that of the seasons of the year, through the suc-

cession of which all things take birth, that is, spring, summer, autumn and winter. The eleventh is that of the ages: childhood, adolescence, maturity and old age.

There are thus eleven quaternaries. The first is that of the numbers which are formed by addition, the second is that of the numbers formed by multiplication, the fourth is that of magnitudes, the fifth is that of simple bodies, the sixth is that of created things, the seventh is that of societies, the eighth is that of the faculties of judgment, the ninth is that of the living things, the tenth is that of the seasons, and the eleventh is that of the ages. They are proportional to one another, since what is unity in the first and the second quaternary, the point is in the third, fire is in fourth, the pyramid in the fifth, the seed in the sixth, man in the seventh, thought in the eighth, and so forth with the others following the same proportion.

Thus the first quaternary is 1, 2, 3, 4. The second is unity, the side, the square, the cube. The third is the point, the line, the surface, the solid. The fourth is fire, air, water, earth. The fifth is the pyramid, the octahedron, the icosahedron, the cube. The sixth is the seed, the length, the width, the height. The seventh is man, the family, the village, the city. The eighth is thought, science, opinion, sense. The ninth is the rational, the emotional and the willful parts of the soul, and the body. The tenth is spring, summer, autumn, and winter. The eleventh is childhood, adolescence, maturity and old age. And the perfect world which results from these quaternaries is geometrically, harmonically and arithmetically arranged, containing in power the entire nature of number, every magnitude and every body, whether simple or composite. It is perfect because everything is part of it, and it is itself a part of nothing else. This is why the Pythagoreans used the oath whose formula we have reported, and through which all things are assimilated to number.

I am surprised that the great Madame H.P.B. did not remark on the following correspondence between the tetractys and the following Hindu Yogas, although she did claim on numerous occasions that Pythagoras learned his mysteries in India. The figures for these world ages in years were taken from THE SECRET DOCTRINE.

1 = Kali Yuga = 432,000

2 = Dvapara Yuga = 864,000

3 = Treta Yuga = 1,296,000

4 = Krita Yuga = 1,728,000

10 = Maha Yuga = 4,320,000

So sacred is the quaternary, that every Anthropomorphic name of God is written and pronounced by old nations with four letters. For the Egyptians, Teut; the Arabs, Alla; the Persians, Sire; the Magi, Orsi; the Mahometans, Abdi; the Greeks, Teos; the ancient Turks, Esar; the Romans, Deus; the Germans, Gott; and the Tartars, Itga.

The good Madame H.P.B. says, "the Logos is the apex of the Pythagorean triangle. when the triangle is complete it becomes the tetractys, or the triangle in the square, and is the dual symbol of the four-lettered Tetragrammaton in the manifested Kosmos, and of its radical triple Ray in the unmanifested, or its numenon." For Pythagoras, the Logos was the point or monad, from whence, in reflecting upon itself, all things are created. As stated by George Oliver in THE PYTHAGOREAN TRIANGLE,

"a point corresponds with the monad, both being indivisible; and as the monad is the principle of numbers, so is the point of lines. A line corresponds with the dual, both being considered by transition. A line is length without breadth, extending between two points. A superficies corresponds with the triad, because in addition to the duad, length, it possesses a third property, viz., breadth; which is effected by setting down three points, two opposite, the third at the juncture of the lines made by the other two. A solid or cube represents the tetrad; for if we make three points in a triangular form, and set a fourth over them, we have a solid body in the form of a pyramid, which has three dimensions, length, breadth and thickness. In geometry, the tetrad combines within itself all the materials of which the world and all things therein are composed viz., the point extended to a line; a line to superficies; and the superficies or triad converted to a solid or tetrad by the point being placed over it."

Thus, the Logos of H.P.B. and the point of Pythagoras or even the Monad of Leibnitz evolves through geometry, into the three dimensions of the manifest world as reflected in the tetractys symbol. But H.P.B. says that this symbol is dual and also reflects the tetragrammaton. As G. Oliver notes, the quaternary was called tetractys by the Gentiles and the tetragrammaton by the Jews.

The Jewish name of God the tetragrammaton as Jehovah is composed of four letters. Yod (J), He (H), Vau (V) and He (H) or JHVH. Its origin is from Exodus when Moses asked the Lord by what name should He be called if asked by his brethren of Israel. He responded, "I am that I am". Because the Hebrew language does not employ vowels in its written form, the correct pronunciation of the ineffable name of God was lost (the Hiram Abiff Masonic legend of the lost word) until rediscovered by the Quabbalists. They gave it the name of Tetragrammaton or the quaternary

and discontinued the prior use of the name of God as Shem Ha-Meforash, a seventy-two syllable name consisting of 216 letters.

The Hebraic script (gematria) value of the letters is J (10), H (5), V (6) and H (5) for a total of 26. Its relationship as the dual symbol appeared to be well hidden for centuries until the publication of Kircher's OEDIPI AEGYPTIACI which has the following tetractys in Hebrew letters set above a mandala entitled, THE CHRIST OF GLORY and as follows:

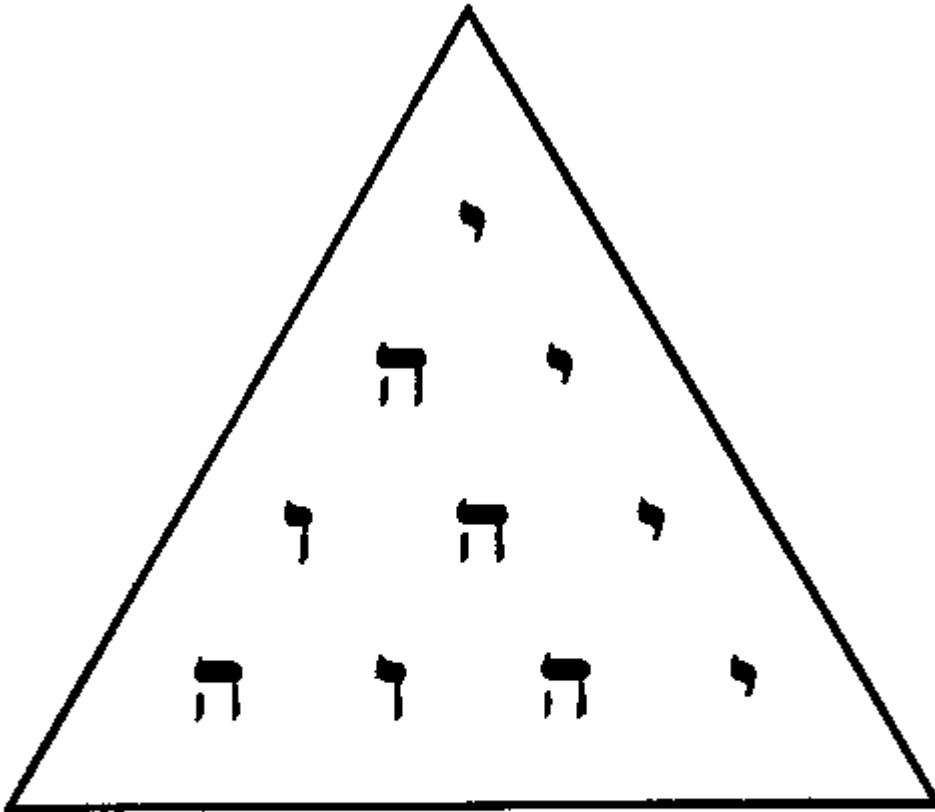

THE TETRAGRAMMATON.

By arranging the four letters of the Great Name, הוהוה (I H V H), in the form of the Pythagorean Tetractys, the 72 powers of the Great Name of God are manifested. The key to the problem is as follows:

$$\begin{aligned}
 \cdot &= 1 &= 10 &= 10 \\
 \cdot \cdot &= H I &= 5+10 &= 15 \\
 \cdot \cdot \cdot &= V H I &= 6+5+10 &= 21 \\
 \cdot \cdot \cdot \cdot &= H V H I &= 5+6+5+10 &= 26 \\
 &&&& \overline{\text{The Great Name of God}} &= 72
 \end{aligned}$$

1.	J	10	10
2.	J-H	10 + 5	15
3.	J-H-V	10 + 5 + 6	21
4.	J-H-V-H	10 + 5 + 6 + 5	26
		(Total)	72

The number seventy-two has significant value to the Jews and the Quabbalists. First, the new tetragrammaton short version of the name of God is reconciled with the long version consisting of 72 syllables used prior to the "lost word". Seventy-two represents the Angels of Jacob's Ladder and the traditional number of the names of God. Also, seventy-two is the value of HESED, the forth sephiroth which represents the manifest world as a cube or the Platonic element of earth.

Within the tetractys we see a triangle, a hexagon and a square. In plane geometry of two dimensions, these three are the three primary plane shapes which will independently fill a surface without leaving any gaps - all space filling. In solid geometry of three dimensions, the hexagon in the center represents a family of 2-3-4-fold symmetry the prime representatives of which are the octahedron, cube and cuboctahedron. Taken in another correspondence, the tetractys represents the basic theme of our study dealing with the Law of Three as representative of Deity and the unmanifested planes and the Law of Seven as representative of manifested plane of creation. By connecting with lines the middle level points, a six-sided hexagon is revealed the hidden cube .

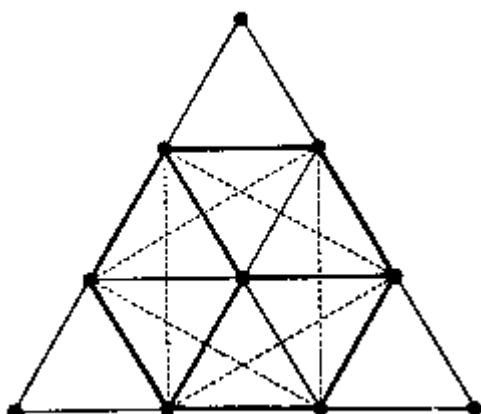

THE CUBE AND THE STAR.

The three points at the corners form a triangle and represent the symbol of the unmanifested planes. The six points of the hexagon and seventh center point represent the seven manifested planes.

In the Quabbalah, the three points represent the upper Holy Triad of Kether, Binah and Hochmah, the head and shoulders of Adam Kadmon and the Atziluth world, all as represented by the Hebrew letter SHIN.

The lower seven points represent the seven lower sephiroth of the manifest world, the creative Elohim of Genesis, all as represented by a cube, the six sides of which are the six days of creation and the seventh (central point) the Sabbath.

This is the key of the tetractys. As a whole, both the universe and man is formed and built upon ten, the decad. Every atom, cell, plant, mind and spiritual being is a complete hierarchy in ten degrees or planes. As a completed whole, everything in cosmos is tenfold, composed of the three as a root and seven in active manifestation.

The Quabbalist symbolism of the central cube hidden in the tetractys was carried forward to the seventeenth century symbolism of the Rosicrucians.

The first exoteric publication appeared at Altona in 1785 entitled, "Secret Symbols of the Rosicrucians of the Sixteenth and Seventeenth Centuries. A.E. Waite has traced the contents of this extraordinary volume back to Frankfurt in 1678 and an original edition in 1625 published in German and translated into Latin. P. Manley Hall in the Secret Teachings reviews the Georgius Van Welding volume of Fifteen Rosicrucian Diagrams published in 1735 and Hall states the correspondence of the cube as symbol of salt and matter:

"The cube has six sides, corresponding to the six days of creation, with the point of rest (the seventh day) in the center of the cube, on each surface of the cube appears the signs of the four elements (as triangles). The cube is composed of twelve bodies, each of which has six sides. These bodies are the twelve fundamental pillars of the true invisible church, and when multiplied by the six sides of the cube, the magical number 72 results. The cube also consists of six pyramids with the six surfaces of the cube as their bases. The point of these six pyramids meet at the center of the cube. These six pyramids, each consisting of four triangles, signify the elements, and produce the magical number 24, which is the Elders before the Throne. The six surfaces and the central point constitute the magical number 7. If 7 is multiplied by 7 over 7 times, the method used by the ancients for measuring the periods of eternity; (not in earth years)

$$\begin{aligned}
 49 &= 7 \times 7 \\
 343 &= 7 \times 49 \\
 2,401 &= 7 \times 343 \\
 16,807 &= 7 \times 2,401 \\
 117,649 &= 7 \times 16,807
 \end{aligned}$$

$$823,543 = 7 \times 117,649$$
$$5,764,801 = 7 \times 823,543$$

The 5,000,000 equals the great Hall year; the 700,000 equals the great Sabbath year, wherein all human beings gradually gain true understanding and became heirs to the original and eternal inheritance, which was lost when they were enmeshed in the lower elements. The 64,800 is the number of fallen angels and the last year is the liberation of Lucifer and return to his original estate".

Another Rosicrucian diagram from this selection shows the cube as the New Jerusalem with the names of the twelve tribes of Israel written on the twelve lines of the cube, and in the center is the eye of God.

A correspondence that bears more scrutiny is the time period calculation shown previously between the Hindu cosmic cycle of the four Yugas and the ancients (later Rosicrucian) periods of eternity as a permutation of cycles of them.

4. ROSICRUCIAN WORLD AGES

The identity of the hidden central cube which when taken with the central seventh point shows how the law of seven operates within the symbol of the whole decad or tetractys. Following the correspondence of the "periods of eternity" of the ancients and the seventeenth century Rosicrucians, it is interesting to see how the nineteenth century Rosicrucians have extended this occult permutation of 7×7 .

R. Steiner in his series of lectures entitled, "THE APOCALYPSE OF ST. JOHN" speaks of the world ages as an "outer scaffolding" that has to be taken down when the building is complete. These lectures were given in 1908 while he was the head of the Theosophical Society in Germany but, for lack of a better term, I will call them the Rosicrucian System because of their correspondence with the Seventeenth Century world ages of the fifteen Rosicrucian diagrams of Van Welling.

He begins with a permutation of 7 as the so-called Post-Atlantean Cultural Epochs

1. Ancient Indian
2. Ancient Persian
3. Assyrian-Babylonian-Egyptian
4. Graeco-Roman
5. Present Cultural
6. Sixth Cultural (Un-named)
7. Seventh Cultural (Un-named)

Each of these epochs represent a cultural phase in the evolution of humanity. For example, the ancient Indian epoch arose about the eighth millennium B.C. and its spiritual, intellectual and moral development was guided by the holy Rishis, through initiation in the mystery schools. The Buddhist and Brahman paths still have a significant spiritual effect on the Hindu culture today.

The second cultural epoch arose in the fifth millennium B.C. with the ancient Persians guided by the teachings of the great initiate of the Sun oracle, Zarathustra.

The third cultural epoch arose about the beginning of the third millennium B.C. This was a time of great scientific advances by the Chaldeans in astronomy and the Egyptians in architecture and socialization of the masses. The fourth cultural epoch coincides with the Graeco-Roman civilization arising in the eighth century B.C. During this time, Christ came into this world in fulfillment of the prophetic vision of the ancient mystery schools and the Jewish prophets.

The present Fifth cultural epoch begins in the year 1413 with the European civilization intellectually rising with the Renaissance and leading to our materialistic age of modern science.

Each cultural age represents a stage of the soul evolution of the human ego. At the end of the seventh cultural epoch, Steiner says, will come the great "war of all against all" wherein civilization will be destroyed except for a select few whose destiny is to begin the evolution of the next sixth root race.

Steiner next proceeds with a second permutation of 7 as the so-called root-races or evolutionary epochs.

1. Polarian Race
2. Hyperborean Race
3. Lemurian Race
4. Atlantean Race
5. Aryan Race
6. Sixth Race (Un-named)
7. Seventh Race (Un-named)

In the first two root races, we do not see man in the sense of the physical body we have today. Basically, these epochs were the evolutionary stages of an astral proto-type which descended and materialized into the first human

form during the middle of the third Lemurian Race at which time, the first "fall" of mankind occurred, the division of the sexes into sexual generation. The location of the Lemurian continent was south of Asia in the Indian and Pacific oceans and extended from Ceylon to Madagascar. The tectonic plates of this long since submerged continent have caused the uplifting of the Himalayan mountains. The Remnant survivor sub-races from this civilization destroyed by "fire" are to be seen in the Aborigines of Australia.

Each root race has physical and mental characteristics peculiar to it. The task of the fourth root race was to develop human memory and its keystone was communication by speech and language. Each root race also has a permutation of 7 known as sub-races. The sub-races for the Atlantean race are:

1. Rmoahals - feelings, personal and ancestral memory.
2. Tlavatli - personal ambition.
3. Toltecs - social communal life, kings.
4. Primal Turanians - abuse of power.
5. Primal Semites - logical thinking.
6. Akkadians - social order and laws.
7. Mongols - duty to ancestral memory.

The epoch of the Atlantean Race ended about one million years ago by destruction with "water" and the subversion of the Atlantis continent in the Atlantic Ocean. We are now in the middle of the fifth or Aryan Root Race.

The next Septenary world age Steiner describes as Conditions of Forms.:

"Before something becomes physical it is astral; before it is astral it is at a spiritual stage which is called Lower Devachan; and before anything descends to this stage it is in a higher stage of devachan. When the astral condenses it becomes physical. Then the physical dissolves again and returns to a more perfect astral. This passes to a more perfect lower devachanic form; and this to a higher devachanic form. The physical condition of form is in the middle."

This means that our planet Earth is in an intermediate physical stage, after condensing from the former astral stage and in the future will dissolve and ascend to the more perfect astral stage.

Thus, the conditions of form through which every kingdom passes,

1. higher Devachan
2. lower Devachan
3. Astral
4. Physical (present earth in middle stage)
5. more perfect astral
6. lower Devachan
7. higher Devachan

The next Septenary world age is called by Steiner the Conditions of Life and is represented by the seven so-called kingdoms of nature.

1. First Elementary Kingdom
2. Second Elementary Kingdom
3. Third Elementary Kingdom
4. Mineral Kingdom (present mankind in middle stage)
5. Plant Kingdom
6. Animal Kingdom
7. Human Kingdom

The elementary kingdoms are those of the gnomes, sylphs and undines as described by Paracelsus in the 16th Century. Mankind, now, has its consciousness only in the Fourth mineral kingdom. By this is meant that he can control the forces of nature in this kingdom only. For example, from the mineral kingdom, he can build houses and machines and even synthetic crystals. However, his knowledge has not yet penetrated those same forces to create out of the plant kingdom. Our current progress in DNA genetics research in producing DNA altered and implanted microbes is a reflection of this future direction of evolution.

The last Septenary world age is called by Steiner the seven conditions of Consciousness and this relates in the microcosm to the septenary bodies of man described in The Law of Seven. There it was shown that the evolution of man was a progressive control by the ego or fourth body over the unfolding of the three higher principles in man. For example, to the extent that the ego has worked upon the astral body so as to gain control of the animal instincts and passions, one is said to have developed his fifth principle or Manas. Likewise, as the ego controls and transforms the etheric body, one is said to have developed his sixth principle or Buddhi. Likewise, ego control over

the physical body develops the seventh principle or Atma. We said before that man now is represented only as a pentagon because at this evolutionary state, he has only begun to work on his fifth principal of manas. In the future, at the end of the Vulcan Round he will some day have the completed triangle of three higher principles wholly within the quaternary of the four lower principles.

Steiner relates this unfolding of the sevenfold nature of man on the macrocosmic planetary scale in the seven Conditions of Consciousness as,

- MACROCOSM-----MACROCOSM
1. Old Saturn ----- Physical body
 2. Old Sun -----Ethereic
 3. Old Moon -----Astral
 4. Earth --(present earth)----- Ego (present mankind)
 5. Jupiter -----Manas
 6. Venus - -----Buddhi
 7. Vulcan ----- Atma

Thus, the physical body of man was developed in a planetary stage called - old Saturn, etc. Mankind is presently in the Fourth or Earth State wherein the ego is being developed during the seven cultural epochs as aforesaid.

In conclusion, the periods of eternity described numerically only by the seventeenth century Rosicrucians, has been further described by the nineteenth century Rosicrucian Steiner as,

7	Conditions of Consciousness	4 th
7 X 7	Conditions of Life	4 th
7 X 7 X 7	Conditions of Form	4 th
7 X 7 X 7 X 7	Root Races	5 th
7 X 7 X 7 X 7 X 7	Atlantean sub-races	
7 X 7 X 7 X 7 X 7 X 7	Cultural epochs	5 th

Having briefly discussed the seven planetary conditions, this throws some light on the symbolism on the "twenty-four elders before the Throne" mentioned in connection with the central cube of the 17th Century Rosicrucians. Steiner says that during each planetary condition, certain beings reach their evolutionary potential and then pass onto higher celestial hierarchies. For example, during Saturn Round, the Asuras or Archaia, during the Sun Round, archangels and during the Moon Round, the angels, reached the human or Seventh Condition of Life. Afterwards, they passed on and have progressed further than man, but they can still look back and remember their evolution. They can look down upon evolving mankind from their spiritual cosmic realm and help guide and regulate man's evolution. Of those beings who have passed on to higher realms, seven from the Saturn Round, seven from the Sun Round, seven from the Moon round and three from the Earth Round (twenty-four in all) have remained behind to help guide the evolution of man. These directors of time are called in Western occultism the twenty-four elders before the Throne, the original historical reference coming from the Apocalypse of St. John. It is important to observe that the number of the Elders (24) is not derived from the Law of Twelve (12+12), but from the Law of Seven (7+7+7+3) and the central cube of the tetractys. In Eastern occultism there is a similar doctrine where in the directors of time are called Lords of Compassion and the elders are called Dhyani-Buddhas.

Lastly, some explanations should be offered as to where mankind stands in this scheme of world ages at the present time. Each planetary round or Condition of Consciousness can run its course only after seven Conditions of Life and each Condition of Life can only run its course after seven Conditions of Form. Thus, the entire Earth evolution requires $7 \times 7 \times 7 = 343$ Conditions of Form.

Since we are now in the fourth Planetary Round or Condition of Consciousness, then Old Saturn has passed through 7 Conditions of Life and 7 Conditions of Form for a total of $7 \times 7 = 49$. Likewise, the old-Sun has passed through 7×7 or 49 Conditions of Form and the moon as passed through 7×7 or 49 conditions for a total of 147 Conditions of Form ($49+49+49$).

These 147 conditions bring us to the present Fourth Planetary Round of Earth. On Earth, mankind has already passed through three Conditions of Life or three rounds and we are presently living in the Fourth Round of the Mineral kingdom. Thus, we add 3×7 or 21 Conditions of Form to the 147. In addition, man has lived through the first 3 Conditions of Form (the higher and lower Devachan and Astral) leaving four Conditions of Form for future evolution. The total is

$$\begin{aligned}
 7 \times 7 &= 49 \text{ old Saturn} \\
 7 \times 7 &= 49 \text{ old Sun} \\
 7 \times 7 &= 49 \text{ old Moon} \\
 &147+ \\
 &3 \times 7 = 21
 \end{aligned}$$

$$3 = 3$$

Total = 171 Conditions of Form

Man is presently living in the Fifth Cultural Age (beginning in 1413) of the Fifth or Aryan Root Race of the 172nd Condition of Form. In relation to a total of 343 Conditions we are living in number 172 just past the middle of evolution! What a wonderful thought and place to be.

The following table of correspondances is a summary:

7 PLANETARY CONDITIONS=MANVANTARAS						
Old Saturn	Old Sun	Old Moon	Present Earth	future Jupiter	future Venus	future Vulcan
7 LIFE KINGDOMS-ROUNDS						
1 ST elementary kingdom	2 nd elementary kingdom	3 rd elementary kingdom	Present mineral kingdom	future plant kingdom	future animal kingdom	future human kingdom
7 CONDITIONS OF FORM-GLOBES						
Arupa	Rupa	Astral	Present physical	More perfect Astral	Rupa lower devachan	Arupa higher devachan
7 ROOT RACES						
Polarian	Hyper-borean	Lemurian	Atlantean	Present	future 6 th	future 7 th
Aryan 7 SUB-RACES/CULTURAL EPOCHS						
Hindu/ Indian	Persian	Egyptian/ Chaldean	Greek/ Roman	present European	future Slavic	future American

5. HINDU YUGA CYCLE

We saw in the Rosicrucian world ages a cosmic cycle as a permutation of seven, which seven is taken from the central cube and hidden seventh point residing within the tetractys. We tracked the source of this system beginning with the Quaballah, through the Apocalypse of St. John in the New Testament, to 17th Century and finally 19th Century Rosicrucian symbolism. This is the progression of Western occultism.

The progression of the Eastern occultism is based upon the Hindu Yuga cycle of 4-3-2 and not the Rosicrucian cycle of 7 x 7, although the two cycles are related, as will be later shown. Both Western and Eastern occult cycles are drawn from the tetryactys.

First, as described on page , the Hindu Yuga cycle is most definitely based upon the tetractys with a root number of 432 which is the tetractys ratio in reverse order, with the number 1 or unity dropped, viz: 1-2-3-4 reversed to 4-3-2- (1 dropped). Thus, the numbers of years in a Kali Yuga is 432,000 years and each successive Yuga adds to the tenfoldness of the Maha Yuga of 4,320,000 years.

Now, the Hindu Yuga cycle as well as the Chaldean numerical and astronomical systems stem from the grand occult solar precessional cycle called the Great Platonic Year. We shall see this cycle frequently, but a simple description follows.

The sun travels across the sky on a pathway called the plane of the ecliptic which is also a line that passes through the 12 constellations of the zodiac. The signs of the zodiac are not equal but approximate divisions of this great circle, which when divided into twelve equal parts would have equal arcs of 30 degrees. The position that the sun occupies at the moment of the solar equinox is called the first point of Aries. This point moves each year and in fact moves in a retrograde direction so that there is a lag between two successive coincidences of the spring equinox in relation to two successive coincides of the sun with the same point in a given constellation (sidereal year). This annual lag is calculated by occultists as about 50 seconds per year which amounts to 1 degree in 72 years (50" x 72 = 3600" = 60' = 1) and further to 2,160 years to 30 degrees or one sign of the zodiac and a full zodiac cycle of 12 x 2,160 or 25,920 years. These numbers of 60, 72, 2,160 and 25,920 are very occult numbers and will be dealt with separately, but the important object here is that they are derived from the complete solar precessional cycle of 25,920 years.

The discovery of this solar cycle is attributed to the Greek astronomer Hipparchus in the year 125 B.C. However, this is an exoteric designation given by Western science including the appellation "great Platonic Year". That it was known to Chaldean astronomers is obvious from the fact that the entire mathematical, geometrical, astronomical and

musical arithmetic of the Babylonians was sexagesimal or based upon the unit of 60. Divide the standard Babylonian base number of 60 into the solar precessional year and the result is our tetractys base number of 432!

This sacred number 432 of the tetractys saturates ancient Hindu, Babylonian, Chaldean and Egyptian cosmological systems. For example, according to Berossus, the reign of the ten antediluvian kings in the Babylonian Marduk mythology was 432,000 years and this was called their "great year". In the Hindu RIG VEDA, (the oldest written text) the 10,800 stanzas average forty syllables per stanza for a total of 432,000. In the geometry of Ptolemy, the diameter of his great circles is 432,000 and in his musical theory 432,000 is the least common denominator of his monochord fractions.

The Hindu Yuga for measuring eternity is based upon the Maha Yuga cycle, taken from the tetractys, the 4-3-2 springing from the monad and tenfold powers of the sacred decad. A day of Brahma is equal to 1000 cycles of the Maha Yuga, the year of Brahma is 360 such days and the life of Brahma lasts for 100 such years.

4,320,000 ----- 1 Maha-Yuga----- (root race cycle)
308,448,000 -----1 Manvantara----- (minor round)
4,320,000,000 -----1 Day of Brahma----- (Kalpa or manvantara)
4,320,000,000 -----1 Night of Brahma
8,640,000,000 -----1000 Cycles of Maha-Yuga----(Day and night together)
3,110,400,000,000 -----1 Year of Brahma or 360 Kalpa's
311,040 x 10-----1 Life of Brahma of 100 Years---(Maha-Kalpa)

These figures represent the upper end of the cosmic cycles of the life of Brahma which H.P.B. says is also the life or duration of our solar system.

Although the figures given in the Secret Doctrine are a confused blind, G. dePrucker, on several occasions, states that "at the present period, we have lived somewhat more than half of the Maha-Manvantaric cycle" or 50 of the Divine years in the life of Brahma. Thus, there remain over 155 trillion, 520 odd billion years in the cosmic cycle of the life or duration of our solar system.

To get an idea of the figures for the lower end of the cycle, we can recall the following from Secret Doctrine, "there are seven rounds in every manvantara; this one is the fourth and we are in the fifth-root race at present. Each root race has seven sub-races, every sub-race has seven ramifications which may be called Branch or Family races".

Thus this system is exactly similar to the so-called Rosicrucian, as,

7 Family Races =-----Sub-Root Race
7 Sub-Races = -----1 Root Race
7 Root Races = -----1 Globe Round
7 Globe Rounds = -----1 Planetary Round or Manvantara
7 Planetary Rounds =-----1 Maha-Manvantara or Kalpa
-----= ----- 4,320,000,000 years or day of Brahma

However, Steiner was very careful never to express the Rosicrucian cycles in ages of years. The Madame H.P.B. does give some idea of the length in years when she says there is, "comparative approximation of duration between the lives of a family race and a sidereal year." We know the cycle of the occult solar sidereal year is 25,920 years. Steiner does seem to relate the length of each cultural epoch (the present fifth one beginning year 1413) in terms of 2,160 years or one-twelfth of a solar year.

Another hint is given by Madame H.P.B. in reference to the Kali Yuga cycle when she says it begins in the year 3102 B.C. and the first 5,000 year cycle ends in 1898, a year of great significance. As shown on page , a Kali Yuga consists of 432,000 years of which, then, in 1992, 426,906 years remain in the cycle. Also, the Maha-Yuga cycle of 4,320,000 years is frequently referred to as a root race cycle, remembering that at the mid-point of a cycle, a new root race begins.

The Madame does state that the revealed cycles in years is veiled in a blind for the exoteric population. This is why the Brahmin figures published in the Secret Doctrine are internally inconsistent and unworkable. But part of the blind may be explained in that area where the two (Western and Eastern) occult systems coincide. As said earlier, the Western system is based upon a 7x7 permutation that does not reveal actual time in earth years, while the Eastern system is based upon a 4-3-2 permutation that reveals some cycles in actual earth years, as shown above in the years of the Maha-Yuga Kalpa, and life of Brahma. But where does the 7x7 and the 4-3-2 coincide?

The place to start would be the solar sidereal year or Great Platonic Year of 25,920 years since we have shown that both Eastern and Western occult systems acknowledge that cycle. The Madame's duration for a "family race" is about 25,920 years and Steiner's duration for a cultural epoch is 2,160 years.

Now, the cycle of 2,160 years is called a "Messianic cycle" in Western occultism, and is associated with one sign of the zodiac. Thus, the second cultural epoch of the Persians under the sign of Taurus, was commenced with the appearance of Zoroaster. Likewise, the third cultural epoch of the Egyptians under the sign of Aries was swept in with the appearance of Hermes or Thoth. The fourth cultural epoch of the Greek-Roman civilization began about 60 B.C. under the sign of Pisces and historically designated as the fish as Taurus was designated as the bull, etc. In the Talmud of the ancient Jewish priests, the Messiah was called Dag or Fish, and the Messiah was to come "in conjunction of Saturn and Jupiter in the sign of the fish" or Pisces. Thus, Christ and early Christians took the symbol of the fish.

Thus, at the commencement of each cycle of 2,160 years, there appeared a new Messiah or spiritual teacher and we expect the next in the dawn of the age of Aquarius.

Now, the Messianic cycle (2160) and the Hindu (4320) cycle coincide in the two turns of the key as $2 \times 2,160 = 4,320$, and both cycles are whole fractions of the solar sidereal cycle of 25,920 years, one-twelfth and one-sixth, respectively.

In conclusion, the Rosicrucian and Hindu-Yuga cycles correspond as follows:

Us Now -----Rosicrucian----- Hindu

-----7 Planetary Conditions----- = 1 Life of Brahma or Maha-Kalpa

4th (Earth)----- Planetary Conditions----- = Maha-Manvantara or Kalph

4th (Mineral) -----Conditions of Life----- = Planetary Rounds

4th (Physical) -----Conditions of Form----- = Globes

5th (Aryan) -----Evolutionary Epoch-----= Root Races

5th (1413) -----Cultural Epochs-----= Sub-Races

Leaving aside the 7 Planetary Conditions and 7 Rounds, since we have passed through 3 Conditions of form (Globes) and 4 Root Races and 4 Cultural Epochs, the current number of our evolution in apocalyptic language is 3-4-4 and with the birth of Christ during the 4th cultural epoch, the number of the Messiah is 3-4-3. What is the significance of the number of the beast 6-6-6?

6. THE SYNERGETIC TETRACTYS

A. Tetractys Frequency Grid

If we have two events, the number of lines connecting the events is one. If we have three events, the number of lines connecting the events is three. Likewise, for four events, the number of connecting lines is six and for five events the number of connecting lines is ten. B. Fuller discovered the algebraic relationship as $R = N(\text{squared}) \text{ minus } N \text{ divided by } 2$. where R equals the minimum number of relationships and N equals the number of events. This is demonstrated in the following grid table .

EVENTS	CONNECTIONS	$\frac{N^2-N}{2}$	CLOSE PACKED
1.			
2.		ONE	
3.		THREE	
4.		SIX	
5.		TEN	

Thus, in a world of random events, each event can be connected to each other event by a line of communication. However, in this random arrangement there is always an underlying order that relates to the Tetractys. Looking at the last column, the sum or total of all close packing of the number of relationships is always triangular in the form of a tetractys! Thus, when we look at the apparent randomness of the stars in the sky, the sum total of their relationships or experiences is always symmetrically triangular in the close packed form of the tetractys.

Thus, we can see that nature always close packs its relationships in a triangular form. The same is also true for three dimensional relationships. Modern science always refers to X as 'squared' and X as 'cubed', as shown in Plat No. , regardless of the grid frequency, triangling instead of squaring is always more economical because a triangle takes up less space than a square and tetrahedron takes up two-thirds less volume than a cube. The arithmetical results of space and volume are always the same, but the tetractys frequency grid is more efficient and economical.

Now, the tetractys frequency grid has some interesting qualities. First, it represents the underlying triangling of nature. As we showed on page , the only stable polygons have triangular faces. All polygons are reducible to triangles and are not further reducible. All polyhedra are reducible to triangulation and not further reducible. Second, it utilizes 60 degree coordination which we discussed supra as the most efficient geometry. The 90 degree X-Y-Z coordinate system is less economical because it is based upon a square and cube. In addition, in 90 degrees coordination, the lengths of radials are unequal so that the hypotenuse of 90 degree angles do not integrate with circumference lengths.

Whereas, 60 degree coordination operates either circumferentially or radially because the angles, lengths, arcs and chords are of equal length. The prime structural relationship of all polyhedrons and polygons is with the 60 degree angle.

Third, its symmetry is a model of equilibrium. The triangular grid is composed of equal angles which produce equal arcs and equal chords. The internal length between each monad or point is equal and the internal lengths between different monads is proportionally equal in a harmonic relationship. If nature abhors an equilibrium as much as she abhors a vacuum, then the tetractys frequency grid is her model of perfection.

B. Isotropic Vector Matrix

If each monad or point within the tetractys frequency grid is likened to the centers of equal radius spheres, the geometric result is called by R.B. Fuller, the Isotropic vector matrix , isotropic meaning everywhere the same and isotropic vector meaning everywhere the same energy conditions.

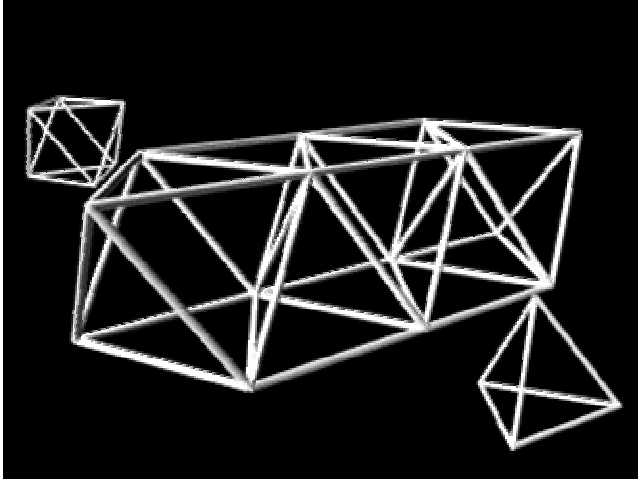

This prescribes an everywhere state of equilibrium in close packed spheres. The vector matrix is composed of only two polyhedra, the tetrahedron and octahedron, which act as all space fillers.

The tetractys as drawn by Pythagoras is a two-dimensional plane geometry frequency grid. The isotropic vector matrix is the three-dimensional solid geometry analog of the tetractys. The matrix represents an aggregation of equal sized spheres - close packed, but removing the spheres and leaving the vectors. This tetrahedron - octahedron complex Fuller also calls the " octet truss ".

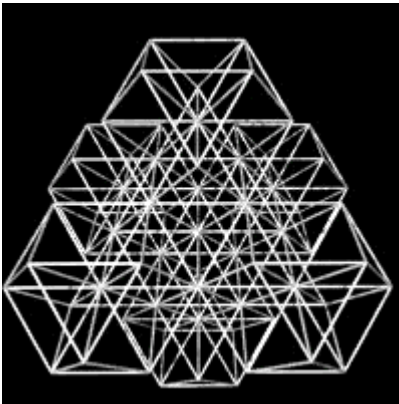

Each line within the maze represents a vector. It is four-dimensional and also employs 60 degree coordination.

Every vector leads from one nuclear center to another and represents the operational effect of a merging of any two or more force centers upon each other. Each vector is composed of two halves, each half belonging respectively to any two adjacent nuclear centers. Each half of the interconnecting vectors represent the radius of one of the two spheres tangent to one another at the vector mid-points.

Fuller recognized a most important principle and an inherent property of the isotropic vector matrix. As he says, it "demonstrates the capability of accommodating all symmetrically and asymmetrically terminated, high-frequency energy vectors of any structural shaping". In other words, the matrix accommodates within it any polygon shape.

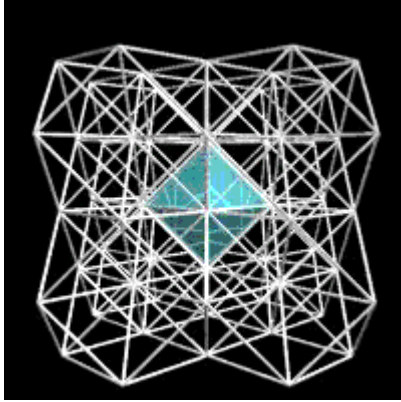

This extraordinary feature is why Pythagoras and his followers for 2000 years right down to Madam H.P.B. in the 19th Century, called the tetractys, the measure of all things, for it contains the structuring of all shapes in the universe. Again, the occult secret wisdom recognized in the tetractys, its analog solid geometry form of the isotropic vector matrix. See Plat No. .

To demonstrate this principle extended through initial frequencies, look at this first and second frequency grid .

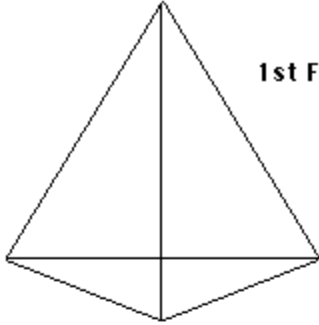

**1st FREQUENCY = TETRAHEDRON OR 0 PHASE -
MONAD OF THE TETRACTYS
AND VECTOR MATRIX**

**2nd FREQUENCY MATRIX = OCTAHEDRON
INSCRIBED BY CONNECTING THE
MID-POINT OF THE 6 EDGES**

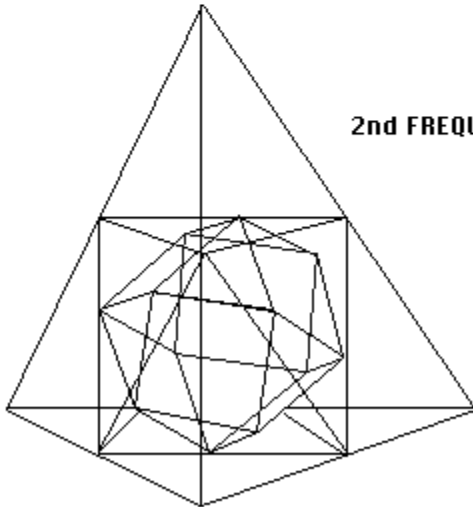
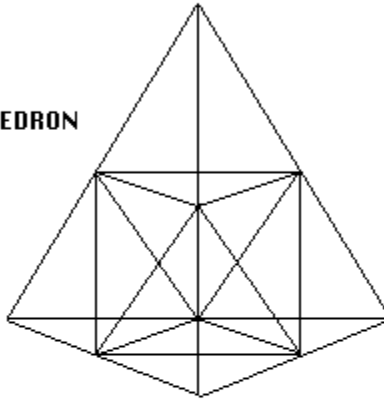

**2nd FREQUENCY = 2nd LEVEL PRODUCES
CUBOCTAHEDRON BY
CONNECTING 12 EDGES
OF OCTAHEDRON AT
MID-POINTS**

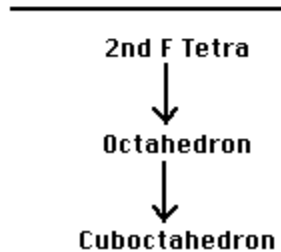

The first frequency of the tetractys is the point or monad. In the I.V. Matrix, the first frequency is a point extended into a sphere. Remove the sphere and leave the vector lines and a tetrahedron results.

The second frequency matrix shows a tetrahedron with the mid-points of the six edges connected to form an octahedron. Taking this a step further, joining and interconnecting the midpoints of the octahedron edges results in the cuboctahedron. Thus, we have a progression of symmetrical polygons from two frequency tetrahedron to octahedron to cuboctahedron. One could have as easily inscribed a two frequency cube as well as shown in the plat. Now look at the three frequency matrix which inscribes a truncated tetrahedron. This is a unique polygon with seven independent axis of rotational symmetry, unknown to the ancient Greeks and discovered by Keith Critchlow. The four frequency matrix grid discloses a number of symmetrical polygons. The first subdivision discloses the familiar octahedron, and as Plat No. shows inscribed within this two frequency octahedron is an icosahedron. We can also see the familiar two frequency cube and at the center of the grid, the nuclear cuboctahedron.

A summary of the three subdivision, four frequency grid is shown as Plat No. , prepared by Keith Critchlow, inscribing the nuclear octahedron, nuclear truncated tetrahedron, and finally the nuclear cuboctahedron. As we proceed to five, six and seventh, etc. frequency matrix grids, other symmetrical and asymmetrical polygons appear both in their original shape and in their truncated shape. For example, Plat No. , shows the truncated tetrahedron within the five frequency grid, that we saw also in the three frequency grid. This demonstrates another important principle that the same polygons appear and re-appear in successive grids in larger and smaller scales of size.

Any polygon whose faces are shaped with triangles, squares and hexagons progressively appear in an infinite series of subdivisions of the original monad or tetrahedron. What the good Madame H.P.B. observed about the tetractys is equally true for its three-dimensional form of the isotropic vector matrix.

"The ten points inscribed within that 'Pythagorean triangle' are worth all the theogonies and angelologies ever emanated from the theological brain. For he who interprets them - on their very face, and in the order given - will find in these seventeen points (the seven Mathematical Points hidden) the uninterrupted series of the genealogies from the first Heavenly to terrestrial man. And, as they give the order of Beings, so they reveal the order in which were evolved the Kosmos, our earth, and the primordial elements by which the latter was generated. Begotten in the invisible Depths, and in the womb of the same "Mother" as its fellow-globes - he who will master the mysteries of our Earth, will have mastered those of all others."

Another remarkable quality of the isotropic vector matrix corresponds to the most ancient Hermetic maxim of "as above, so below". This expression taken from the Emerald Tablet of Hermes as follows.

"True, without error, certain most true; that which is above is as that which is below, and that which is below is as that which is above, for performing the marvels of the Kosmos. As all things are from the one, so all things arose out of this one thing by evolving..."

The one or one thing is of course the first point or monad of the tetractys, from which all things emanate, in the order of the duad, triad and quaternary. The "as above, so below" occult maxim should be re-named the "isotropic maxim" for when we look at the isotropic vector matrix, the way up is also the way down. For example, looking at the two frequency matrix, on the one hand it can be described as a second power or doubling of a single tetrahedron with each edge length being twice the original tetra edge length. On the other hand, it can equally be described as a second power subdivision of the tetrahedron, with each midpoint of the edge length being one-half of the original tetra edge length. The result is equally or isotopically the same. The form or structure of the matrix remains constant in a harmonic relationship of 2:1/2, 3:1/3, 4:1/4, etc, whether the powering is expanding or subdividing. The ancient wisdom surely recognized this isotropic principle.

C. Cube Quanta Modules

The synergetic geometry of B. Fuller may help to explain the mystery of one of our occult numbers - the 72 and its relationship with the cube.

We discussed previously the fourth Sephiroth of the Quabbalah named Hesed which represented the manifested world emanating from the upper holy triad. These six dimensions of the manifested cosmos are represented as the six sided cube with a Hebraic script value of 72. This was the first most ancient occult correspondence between the cube and the number 72, as recognized by the Chaldean and Hebrew Quabbalah.

A second correspondence was recognized again by the Hebrew Quabbalists in the seventy-two syllable name of God before the Lost Word. After the ineffable name of God was rediscovered, it was given the four letter name as represented in the tetragrammaton. But as Kircher discovered, the Hebraic script value of JHVH when layed out in the tetractys matrix still had a correspondence value of seventy-two. Also, the seventy-two angels of Jacob's ladder. A third correspondence was recognized by the 17th Century Rosicrucians in the hidden central cube within the tetractys also representing the manifest cosmos. In addition, the cube consisted of twelve bodies, each of which has six sides, or again, the occult number 72.

A fourth correspondence was recognized in the solar sidereal year cycle. The base term of which was a retrograde motion of one degree in seventy-two years which is also the biblical length of the live of a man at three score plus ten years (exoteric).

In conclusion, the six sided cube has always been identified with the Platonic element of Earth, Matter and the manifested cosmos. Although the cube is geometrically six (sides), it corresponds to the Law of Seven because of the hidden seventh point in the center. The mystery lies in the correspondence by the ancient wisdom of the cube with the number seventy-two.

Fuller can shed some light on this mystery. In the isotropic vector matrix, there are two primary omnisymmetrical polyhedra described by the configuration of the interacting vector lines.

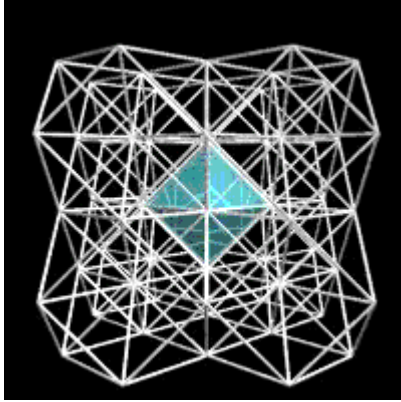

These two are the regular tetrahedron and the regular octahedron. All other symmetric and asymmetric polyhedra (other than the icosahedron and pentagonal dodecahedron) are described by repetitiously compounding rational fractional elements of the tetrahedron and octahedron. These fractional elements or subdivisions of the tetra and octahedron are called by Fuller, the A and B Quanta Modules.

Before Fuller created his modules, a man named Schläfli in 1901 discovered that a polyhedron can be subdivided or built up (the isotropic maximum says it is both) into one or more kinds of oppositely congruent tetrahedrons, which he called an orthoscheme. Now, the orthoscheme is really a skewed tetrahedron, because its four triangular faces are at 90 angles, whereas, our familiar tetrahedron has triangular faces at 60. In any event, Schläfli showed that a polyhedron can be subdivided into component parts, each less than our standard tetrahedron, much like an atom can be subdivided into its component parts of electron neutron, etc.

Fuller's A Quanta Module is a geometrical subdivision of the tetrahedron equal to one-sixth of a quarter tetrahedron. First, a tetrahedron is further divided volumetrically into four equal and identical quarters. Each quarter tetrahedron is divided into six identical irregular tetrahedra, which appear as three right-hand and three left-hand volumetric units equal in volume to one-twentyfourth of the original tetrahedron.

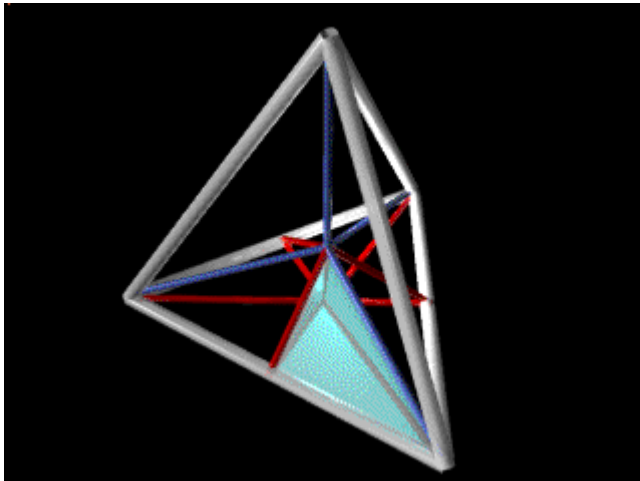

Fuller's B Quanta Module is a geometrical subdivision of the octahedron equal to one-sixth of the fractional unit described by subtracting the quarter tetrahedron from the eighth octahedron. Likewise, an octahedron is divided volumetrically into eight equal and identical units equaling one-eighth of the volume of the octahedron. Thus, the quarter tetrahedron defined by the six A Quanta Modules is subtracted from the one-eighth octahedron, and the remaining fractional unit is subdivided into six identical irregular tetrahedra, again appearing as three right-hand units and three left-hand units.

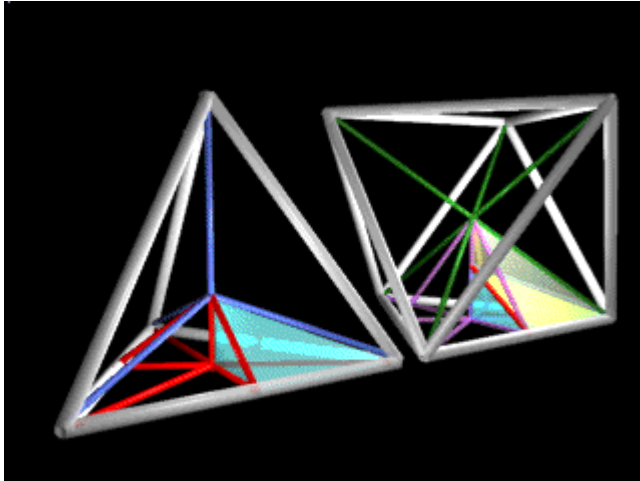

The A and B Quanta Modules have the same $1/24$ th (one-twentyfourth) volume but each are of a different but complementary shape. Together, they structure the tetrahedron and the octahedron and we know that these two structure the isotropic vector matrix. Without getting into the complex geometry of these polyhedra, the A Module has the right angles of the orthoscheme, while the B Module unfolds into a six sided, multitriangled polygon. As Fuller describes them,

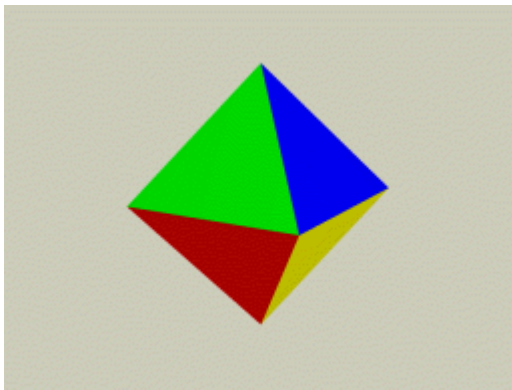

"The A and B Quanta Modules may possibly quantize our total experience. It is a phenomenal matter to discover asymmetrical polyhedral units of geometry that are reorientably compositable to occupy one asymmetrical polyhedral space; it is equally unique that, despite disparate asymmetric polyhedral form, both have the same volume; and both associate in different kinds of simplex and complex, symmetrical and asymmetrical coherent systems. While they consist, in their positive and negative aspects, of four different asymmetrical shapes, their unit volume and energy quanta values provide a geometry elucidating both fundamental structuring and fundamental and complex intertransformings, both gravitational and radiational."

Now comes the amazing part. The A modules can combine with each other in three unique ways, each of which combine as one regular tetrahedron. The A modules can also combine with the B modules in seven unique ways, each of which also result in a single whole tetrahedron. Thus, the correspondence with the Law of Three and the Law of Seven!

And, as Fuller observes, the identical volumes but the uniquely different energy-transforming capabilities hint at correspondence with the behaviors of protons and neutrons. They are not mirror images of each other, but like the proton and neutron, they are energetically intertransformable and due to different shapes they have a slight difference in mass relationships.

Finally, if each A and B module have a volume of $1/24$ th of a tetrahedron, and we know that a cube has a tetra-volume of three, then the volume of our cube is seventy-two! In fact, the cube is composed of 72 energy quanta modules, of which there are 48 A modules and 24 B modules. Herein lies the occult correspondence of the cube and 72! The cube is actually three module layers deep and the layering occurs around each of its eight vertexes. Thus, a single frequency cube is formed in one way by superimposing four eighth octahedra on each of the four triangular

faces of the regular tetrahedron. A two frequency cube is formed by superimposing eight eighth octahedron one each of the eight triangular faces of the regular cuboctahedron. This is important to remember in relation to the Law of Twelve, since a cube formed over a cuboctahedron has a nucleus, which can serve as a complementation domain for the holy spirit.

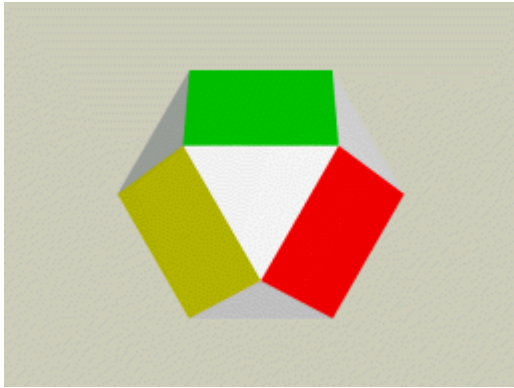

A tetrahedron is composed exclusively of 24 A modules, of which twelve are positive and twelve are negative.

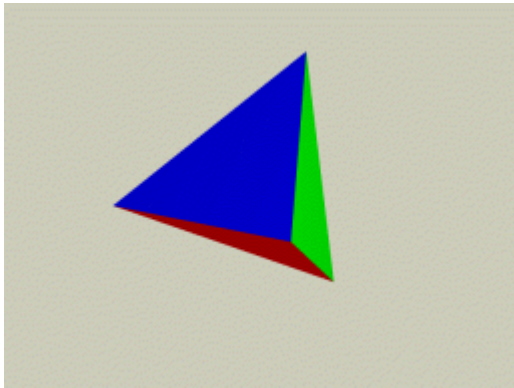

The double tet star tetrahedron

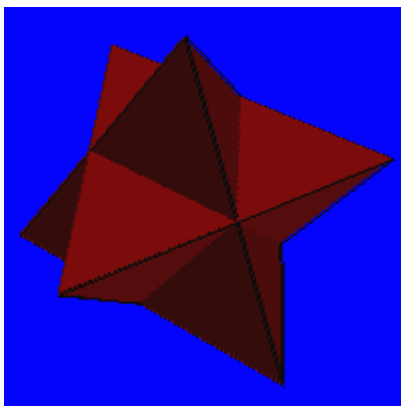

of our "synergetic tetrahedron unfolded" would therefore be composed of 48 A modules.

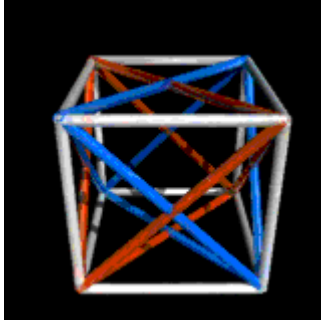

Thus, the 48 A modules in the cube above described. The cube also has 24 B modules which is the complementation domain of the holy spirit in the duo-tet cube.

A partial hierarchy is as follows:

FORM	TETRA-VOLUMES	TOTAL A&B MODULES
tetrahedron	1	24 (24 + 0)
double-tet-cube	3	72 (48 + 24)
octahedron	4	96 (48 + 48)
Cuboctahedron	20	480 (336 + 144)
two-frequency cube	24	576 (384 + 192)

Please note that all of the above total quanta modules are divisible by whole numbers into our solar precessional cycle of 25,920 years. This is an important correspondence that shows that the primary geometric polyhedrons are subdivisions of the solar cycle.

Another key to the cube and its relationship to the messianic cycle regards the sum of its planar angles. Starting with the tetrahedron, B. Fuller states a geometric maximum that, "the sum of all the angles around all vertexes of any polyhedral system is evenly divisible by the sum of the angles of a tetrahedron" and the volumes of all such systems may also be expressed in tetrahedra. The sum of the planar angles of a tetrahedron is 720 as 4 vertexes x 180 = 720. Likewise, the sum of the planar angles of an octahedron is 1440 or 6 x 240. The sum of the planar angles of the cube is 2160 or 8 vertexes x 270 or 6 faces x 360.

Thus, both the cube and our cube unfolded as cross equal in angular degrees the 2160 years in the messianic cycle associated with one sign of the Zodiac or solar precessional cycle. It is for this reason that the ancient occult wisdom represented the perfect man or fully manifested man as a cube. The six sides of the cube represent the six lower principles with the seventh principle or ATMA as the hidden central point within the cube. Thus, the perfect septenary man would not be represented geometrically as a seven sided polyhedra, but as a six-sided polyhedra (the cube) with the spark of God residing within.

D. Conclusion

In conclusion, our symbols of ten disclose a much higher order expressed as the Law of Ten. St. Thomas Aquinas expressed his understanding of the hierarchy of ten as *Inestimabilis et Incomparabilis Magnitudinis!*

It is upon the system of ten that the universe is built. Every complete hierarchy consists of ten degrees. Every atom, molecule, cell, organ, man, planet, sun, solar system and galaxy or as H.P.B. would say, every God, Monad and atom is a completed whole constructed upon the decad. Each hierarchy has a dual tendency and function to exist both as a part and a whole. At every level of hierarchic organization there is a self-assertive tendency that is dis-associative and an integrative tendency that is associative. This polarity between the part function as self-assertive and the whole function as integrative is a universal fabric of life. Dynamic equilibrium exists when these two tendencies counter balance each other. The ten degrees of each hierarchy is structured by the Law of Seven and the Law of Three, together. The visible, manifest world is septenary. The invisible, unmanifest world behind the scene is threefold, with associative, dis-associative and neutralizing forces moving the septenary world in its creations. In addition, the septenary forces of nature operate within the four levels of our Zohar and changing the Quabbalist name for the more modern nomenclature of Plato to:

Atziluth ----- - Archetypal world
 Briad ----- Intellectual or creative world
 Yetzirah ----- - Formative or Astral
 Assiah ----- Physical

Our final symbol of ten is Poculum PanSophia



SOLAR CYCLE OF NAROS

One of the greatest secrets of the ancient mysteries was the solar cycle of Naros or Neros. This was reflected in the age of the world according to early Christians at 6,000 years. Noah was 600 years old at the time the flood ended and a new age began. This symbolism was a bind to show a cycle of 600 years which extended over 10 ages. The beginning of each age saw the birth of a great avatar or spiritual leader for that culture.

Godfrey Higgins in his ANACALYPSIS (1833) describes the Jewish cycle of Naros beginning with Enoch, who did not die but ascended to heaven. The second ended with the birth of Noah. The third ended with Noah leaving the Ark when was 600 years old. The fourth ended about the time of Melchizedek, that high priest of God whom the Essenes in the Dead Sea Scrolls also say lives forever. As to the fifth and sixth cycle, the author is unclear. However, Higgins places the end of the seventh cycle with Elijah, another prophet who did not die, but left his cloak and astral body to his successor Elisha. The eighth cycle began about 600 B.C. with the birth of Cyrus, the king who was described as a sun god and later liberated the Jews from the Babylonian Captivity. The ninth cycle began with the birth of Christ, making eight complete cycles of 600 years each before the birth of the Messiah. Higgins makes no mention of the tenth avatara, but I would suggest he ponder the birth of Mohammed at 608 A.D.

Higgins touches upon an important hidden correspondence in the religious traditions described in the above genealogy. The first reference was to Melchizedek, that priest of the Most High God who was initiated into the mysteries of the sun oracle by Manu himself. At Jeru(salem), he gave bread and wine to Abraham and initiated him to become the father of the Jewish and Persian nations. In the Dead Sea Scrolls (Hebrews 7:1-3) Melchizedek was spoken of as a heavenly high priest who also lived forever, " He is without father and mother or genealogy, and has neither beginning of days nor end of life, but resembling the Son of God he continues a priest forever."

The next reference was to the personage called Enoch by the Jews and EDRIS by the Persians. Both of these cultures related Enoch to Elijah and in both religious traditions, both of whom did not die. Likewise, there is an occult Jewish and Persian (called Al-Choder) tradition that Elijah previously incarnated as "Phinehas, the son of Eleazar, the son of Aaron the priest." Phinehas had single handedly saved the destruction of the Jewish tribe from the wrath of Jehovah when the people of Moses were led astray into idolatry. Steiner confirms this tradition of the continuous line of descent thru the high priest sons of Aaron of the Levite line.

Later, the soul of Phinehas incarnates in the personage of Elijah, who used as a physical vehicle the body of Naboth, the vineyard owner. The Bible tells the story that after Elijah defeated King Ahab's priests of Baal with his sacrifice on the alter of 12 stones on Mt. Carmel, Queen Jezebel, herself an initiated priestess of Astarte, declared her revenge upon Elijah with a death sentence. However, in the Bible, Elijah did not die but passed his mantle on to Elisha, a Korahite. The one who did die was Naboth the vineyard owner who refused to sell his garden to King Ahab.

Through a scheme of Queen Jezebel, he was later invited to a feast where he was stoned to death. Thus, Naboth the physical vehicle for the spirit of Elijah was murdered in satisfaction of the death sentence of Jezebel.

In the GOSPEL OF ST. MARK, Steiner says that Elijah bore within him the folk-spirit of the ancient Hebrew people. This archangel or folk-spirit corresponds to the fifth degree of initiation in the ancient mysteries of Mithras, where the adept is called a "Persian".

In the sixth degree of the Mithras mysteries, the adept is called a "sun hero" (heliodromos). During the Babylonian captivity, the future King Cyrus is born, then abandoned and raised by a Shepard. Destiny followed him as if he was on a Divine mission to conquer Persia and liberate the Jews. Finally, in 538 B.C. he ordered the reconstruction of the Temple of Jerusalem and sent the Jews home from exile. Cyrus was called CAI COSROE derived from CORESH, a Persian name for the sun and the prophecy of Isaiah correctly refers to his birth and not the birth of Christ. By both the Jews and the Persians, he was called a "sun hero" and "sun king" and maybe was another incarnation of Elijah at the level of the sixth degree of the Mithras mysteries.

In relation to the Christ event this incarnating personalty called the Naros was not the Christ, but at least with St. John the Baptist, the messenger of Christ. The Old Testament contains many references to Elijah as an angelic entity who does not die and has a prophecy to return, "Behold, I send my angel to prepare the way before me." In a veiled secret, the Gospel of St. Luke recognized the returned Elijah in the person of the preacher in the wilderness, who ate locusts and wild honey. His mother Elizabeth, wife of the priest Zacharias, was "of the daughters of Aaron" and the angel Gabriel said, "He shall go in the spirit and power of Elias".

In the Jewish cycle, we see the Naros exoterically accepted as an angelic being who never dies in the figures of Enoch, Noah, Melchizadek, Phinehas, Elijah and finally John the Baptist (who did die). In the figures of Noah and King Cyrus we see an esoteric connection with this angelic being. There are many gaps in between and questions to answer for occult research. However, this cycle makes evident at least two important truths. First, the idea of an incarnating personality is accepted exoterically by Western religions and second, this personality is a messenger from God who directs the spiritual guidance of the Jewish and Persian nations.

Historically the Naros cycle represents a luni-solar cycle of 31 periods of 19 years and one period of 11 years making 600 years of 7200 solar months and 7421 lunar months and 219,145/6 solar days. Every 60 years there is a syzygy cycle when all the planets are in conjunction, aligned in a straight line with the sun. The 19 years cycle probably represents the lunar Metonic cycle exoterically named after Meton in 433 B.C. but was most certainly known to ancient Chaldean astronomers. Lunar phases recur on the same day of the month every 19 years. It happens that 235 synodic lunar months are equal to 19 years, which were split into two sets of 12 solar years with 12 lunar months and 7 solar years with 13 lunar months. Although I can not say with certainty, the 600 year cycle represents a renewal of the conjunction of the sun and planets on a new moon at the vernal equinox. For the Gautama Buddha in the Eastern Neros, this conjunction occurred on a Wednesday, the day of Mercury. In Hebrew, the gematria for the letter SAMACH is 60 and as mem final is 600. Many Biblical names use this cipher. Also, it was the practice of the hierophant in the ancient mysteries to make the mark of the 600 on the candidate, "And Joshua the son of Nun was full of the spirit of wisdom: for Moses samached him (Joshua), laying his hands on him". In Ireland the X was the letter for the 600 and the life of the Phenn(icshe) was 600 years as was the life of the Phoenix (or Phen-X) for both the Greeks and Egyptians.

The good Madame H.P. Blavatsky comments in THE SECRET DOCTRINE (III):

"the numerical base of 6, the exoteric figure given by Arya Bhatta, was made good use of. From the first secret cycle of 600-the naros, transformed successively into 60,000 and 60 and 6 and with other noughts added into other secret cycles-down to the smallest, an archaeologist and mathematician can easily find it repeated in every country, known to every nation. Hence the globe was divided into 60 degrees, which multiplied by 60, became the great year. Hence also the hour with its 60 minutes of 60 seconds each. The Asiatic people count a cycle of 60 years also, after which comes the lucky seventh decad and the Chinese have their small cycle of 60 days, the Jews of 6 days, the Greeks of 6 centuries-the Naros again. The Babylonians had a great year of 3,600 being the Naros multiplied by 6. The Tartar cycle called Van was 180 years, or three sixties; this multiplied by (12 X 12) 144 makes 25,920 years, the exact period of revolution of the heavens."

The Naros cycle does not readily coincide with any of the periods of the Messianic cycle of 2,160 years as Higgens observed below in the Enoch cipher. However, every 72 years, the precessional cycle moves one degree and thru a circle of 360 degrees, this equals the great solar precessional year of 25,920 years. If one Naros is given for one degree of the precessional cycle at 72 years, then this would equal the Hindu Kali Yuga (72 X 600) of 432,000 years.

We know that a Messianic cycle for the third cultural epoch began with Melchizadek and Abraham which was carried thru the 3 X 14 generations of the St. Matthew Gospel to the birth of Christ. Higgens correctly suggests that the age of Enoch said to be 365 years would at first glance appear to be a cipher for the solar year. However, if Eusebius correctly set Enoch's age at 360 years by his own calculations from the birth of Methusaleh as suggested by commentators, the the historical age of Enoch was really an intercalation to square with the precessional cycle. The first three Neros total 1,800 years and added to that the age of Enoch at 360 years, then beginning the age of Melchizadek, we have the 2,160 years of the 42 generations of the St. Matthew Gospel.

Convergence of Adepts

Some commentators like to ascribe to the Naros cycle twelve ages of 600 years each for a total of 7200 years in a completed world age. The difference would mean that the ten incarnations of the Messengers who spiritually direct that particular culture, would over the longer cycle appear every 720 years instead of every 600 years. I think it more reliable to follow the 600 year cycle since it fits neatly with the phenomenon of the convergence of adepts that occurred around 600 B.C. and coincides with the birth of Christ 600 years later. One cannot but notice that the age of 600 B.C. was truly a remarkable time, a unique convergence of adepts. In India, the Bodhisattva named Gautama rose to the rank of Buddha. In China, Lo-tzu and Confucius taught a new religious revival. In Greece, Heraclitus and Pythagorus ushered in mathematics, geometry, philosophy and legislative government.

In Judea, the lineage of the great prophets began, starting with Elijah, then, Isaiah, Hezekiah, Jeremiah, Ezekiel, Daniel and Ezra. In the GOSPEL OF ST. MARK (1912), Steiner says that "the souls of the Hebrew prophets are reincarnations of initiates who had lived in other nations and who attained certain stages of initiation". The adepts of former cultures such as in the Hindu, Persian, and Egyptian, all passed thru the stages of initiation within their own national element. We know historically that in the fifth grade of the mysteries of Mithras, the successful candidate was given the name of the nation to which he belonged. Thus, an initiate was called a Persian or in the case of the disciple Nathaniel, he was called by Christ, "an Israelite indeed, in whom there is no guile." This national identity occurs because the adept in reaching the fifth grade was lifted up into the spiritual realm of communion with the archangel of folk-spirit who ruled over that particular nation.

However, one cannot speak of the Hebrew prophets in the same sense as an initiated adept in the Mystery schools. Even the Bible does not describe how the prophets went thru their occult training. Without such an occult initiation, the spiritual vision of the prophets could only have arisen from their own inner genius. The souls of these great prophets did not incarnate from previous lives as a Jew in Judea, but arose from their past lives as initiates from various other nations and cultures. Their spiritual genius was an inherited memory from a past life as an initiate.

Starting 600 B.C., there begins a gradual convergence of adepts brought together in one focal point to be born again out of the blood of the Jewish people. The center of gravity of this convergence was the Babylonian Captivity of the Jews from 587 to 538 B.C. With the destruction of the ten northern Tribes by the Assyrians in 722 B.C., the two remaining tribes preserved the Hebrew tradition in the southern kingdom in Jerusalem. In 597 B.C. Nebuchadnezzar began the deportation of a select group of Jewish leaders. Within ten years, he had razed the city and the Temple and deported the entire population. The Jews in Babylon represent the last third of a combined mystery stream of the 3 X 14 generations of the Gospel of St. Matthew. This priestly line begins with Melchizedek, then the sons of Aaron and the house of David. This was the branch from Abraham and his wife Sarah who with the child Isaac, founded the Hebrew nation. The great prophets of the captivity, Jeremiah, Ezekiel, Daniel and Ezra were all descendant from the Zadek line converging in ancient Chaldea. The other line from Abraham and his wife, the Egyptian Hagar, began with Ishmael and founded the Persian nation, spiritually guided by the Naros Zarathustra. Against this background of the Jews in Babylon occurred the timely incarnation of Zarathas or Nazarathos into the mystery sanctuary of Marduk and the cult of Ishtar. Steiner says that Zarathas was the teacher of the Hebrew initiates during the captivity. He was also the teacher of Pythagoras who one Naros later incarnated as one of the three Magi Kings and later became a disciple of Christ. Corresponding to the adept Jethro who taught Moses in the desert, Nazarathos was the leading spirit of this Chaldean mystery school and his ordained task was to appear one Naros later in an incarnation as the Solomon Jesus child.

Against this background of the Chaldean mystery school, we have at the same historical time the birth of the Buddha mystery stream. When the Gautama Buddha achieved nirvana, he passed on his mantle to the Bodhisattva who later incarnated in the person of Jeschu ben Pandira, the Teacher of Righteousness in the Essene community in Qumran. This mystery stream merged one Naros later when the nirmanakaya of Buddha was given to the Nathan Christ child.

The purpose of the convergence of adepts and the three mystery streams was to prepare for the Christ event one Naros later. This three-fold merger of the Jewish, Chaldean and Buddha mystery streams through their human representatives of Ezekiel (and the other prophets), Nazarathos and the Bodhisattva was only made possible thru the archangel Michael. Prior to this great age, Michael had been the guiding folk-spirit of the Jews until He ascended, in his turn, to the status of Spirit of the Age. Michael as countenance of the sun, whose angelic body would host the Christ ego as He descended thru the heavenly spheres to incarnation during the baptism at the Jordan river, led a golden age which converged in the Babylonian Captivity.

The Star of the Magi

The convergence of Adepts starting 600 B.C. was a remarkable historical event in preparation for the Christ event one Naros later. As told by R. Steiner in **THE GOSPEL OF ST. MATTHEW**, about 100 B.C. the Bodhisattva of Buddha incarnated in Judea in the person of Jeschu ben Pandira. He became the Teacher of Righteousness as described in the Dead Sea Scrolls at the Essene community at Qumran. His task was to teach and prepare the members of this community the cosmic significance of the birth of the Messiah. Pliny said there were about 6,000 Essenes at the monastery at Qumran. Of course, only a few of these members could understand the signs of the times. At the same historical time, the Magi of the Chaldean mystery school were also waiting and watching for the signs of the birth of their Naros, Zarathustra.

Dr. Ernest Martin in his book, **THE STAR THAT ASTONISHED THE WORLD (1991)** describes the astronomical events that occurred in the heavens in the two years prior to the birth of Christ. Of course, there is always an astronomical key to every great symbol. One key was described by a Jewish Rabbi named Abarbanel (1437-1508) who said to look for a conjunction of Saturn and Jupiter in the constellation of Pisces as the time for the birth of the Messiah. Kepler also suggested this sign as did the good Madame H.P. Blavatsky in **ISIS UNVEILED**.

In the 19th. century an extrapolation of this configuration by Ideler showed three conjunctions of Jupiter and Saturn in Pisces in the year 7 B.C. However, the problem with this date is that it is too early to square with the writings of early Christians who insist the birth date to be between 3 to 1 B.C. Dionysius Exiguus in the 6th. century gave a date of 1 B.C.

Most historians place the birth of Christ in the spring of 4 B.C. This stumbling block comes from the testimony of Josephus who wrote that King Herod died soon after an eclipse of the moon and was buried before the spring Passover. Nineteenth century astronomers calculated that such an eclipse occurred during the evening of March 13, 4 B.C. which was just one month before the spring Passover. The problem here as stated by Dr. Martin is that 29 days between the eclipse and the Passover was too short a time to conduct "the grandest funeral ever bestowed upon a King" so great as Herod.

Dr. Martin selects the date of January 10, 1 B.C. at which time there was a total eclipse of the moon at 1:00 a.m. as seen from Jerusalem. This gives 12 1/2 weeks to conduct a funeral for Herod before the spring Passover. This also solves another problem. The Bible says that King Herod consulted with the Magi concerning the signs in the heavens and as a result, he ordered the slaughter of the innocents, being all male children under two years of age. However, nothing spectacular occurred in the heavens between the Jupiter-Saturn conjunction in 7 B.C. and the supposed historical date of Herod's death in 4 B.C.

As a matter of astronomical fact, Dr. Martin states that the heavens were silent until the spring of 3 B.C., when everything under the sun began to happen. He has shown several of the major conjunctions as follows:

19 May 3 BC	22:47	mercury-saturn
12 June 3 BC	16:06	venus-saturn
12 Aug. 3 BC	5:20	venus-jupiter
31 Aug. 3 BC	21:03	mercury-venus
14 Sept. 3 BC	5:05	jupiter-regulus
17 Feb. 2 BC	15:15	jupiter-regulus
8 May 2 BC	16:10	jupiter-regulus
17 June 2 BC	17:53	jupiter-venus
26 Aug. 2 BC	15:15	mars-jupiter

The Hebrew name for the planetary spirit of Jupiter is (T) ZADEK. From this name derives the priestly caste of Melchizedek, the King of Righteousness. The planetary angel is SACHIEL, the intelligence is IOPHIEL and the spirit is HISMAEL. Jupiter is also the ruling planet of the constellation of Pisces in the fourth precessional cycle.

As Jupiter is the king planet, so Regulus is the King Star, located in the foot of the lion in the constellation of Leo. It is one of the Royal stars: Regulus in Leo, Aldebaran in Taurus, Antares in Scorpio and Fomalhaut in the mouth of Pisces, on which falls the water poured out by Aquarius. In the Hebrew camp in the desert, the central division was four-fold representing the ancient four elements and the four fixed signs of the zodiac, which in turn were ruled by the four Royal stars. The King Star Regulus rules in Leo the sign of the lion, which is also the "lion of the tribe of Judah." The gematria of J(10), U(6), D(4), A(1) and H(5) is 26, the number of JHVH Jehovah. The three conjunctions of Jupiter and Regulus would have looked viewing from Jerusalem like a halo or crown circling over the King star.

The conjunction of Jupiter-Venus on June 17, 2 B.C. was separated by only 0.01 degrees. This would have appeared viewed from Jerusalem as a brilliant double star also visible west from Babylon. Again, 72 days later, a last conjunction of Jupiter-Mars occurred in midafternoon. The significance of this conjunction

corresponds to what Steiner says in *THE MISSION OF FOLK SOULS* (1910) that the nations of Asia Minor and Western Europe are especially under the influence of the planetary spirit of Jupiter. To prepare for the descending Christ spirit, a special occult arrangement was made with the planetary spirit of Mars to allow JAHVE as Elohim (Spirit of Form) to work in the blood of the Hebrew Semitic nation. The God of Abraham, Isaac and Jacob worked in the blood without interference from the Mars planetary spirit thru the 3 X 14 generations of the St. Matthew Gospel.

Dr. Martin relates that all the ancient planets, except Saturn, were clustering together in the constellation of Leo, while the moon was entering Leo and the sun was entering the sign of Virgo, the celestial Virgin. He says, "Recall that the account in the New Testament said the Magian astrologers saw the star rising above the eastern horizon. And on August 12, 3 B.C., Jupiter rose as a morning star which soon came into conjunction with Venus. That started Jupiter off on a journey in which six conjunctions with other planets and the star Regulus took place. The final planetary union was the massing of the planets which occurred with Mars, Venus and Mercury on August 27, 2 B.C."

Indeed, the signs in the heavens that occurred between 3 and 2 B.C. were brilliant, spectacular and full of Messianic meaning. Finally, in December of the following year of 2 B.C., the planet Jupiter left its cluster with the other three planets and continued its apparent westward motion, until on December 25, it became stationary over Bethlehem. This stationary position between the retrograde motions of Jupiter lasted about six days and also placed its position in the abdomen region of the sign Virgo, the Celestial Virgin.

The Two Jesus Children

Dr. Martin's astronomical re-working of the planetary motions immediately prior to the birth of Christ, set up two important dates. The first being the conjunction of Jupiter and Venus on June 17, 2 B.C. as a celestial impregnation of the King Planet and the Mother, Venus. The second being the traditional Christmas day event of December 25th., 1 B.C. when the King Planet stood still over Bethlehem for six days.

Certainly one could speculate that these two planetary events were celestial signs for the birth of St. John the Baptist and the birth of the Christ child. The ancient wisdom of the Jewish Naros could predict the messenger of Christ in John the Baptist from the Phinehas-Elijah (sons of Aaron) line and in the line of the Persian Naros, the Magi went to Bethlehem looking for signs for the re-birth of Zarathustra. The profound esoteric wisdom here is that the Magi searched for and accepted the birth of the Christ child in Bethlehem as an incarnation of Zarathustra. Thus, the Persian Naros became the physical vehicle for the incarnation of the Macro-cosmic Christ ego thirty years later at the baptism in the Jordan.

However, at the Essene monastery at Qumran, the pupils of the Bodhisattva Jeschu ben Pandira were looking for more than only two signs in the heavens. They knew something that the rest of the then ancient world did not know and the key to this secret was preserved in the *MANUAL OF DISCIPLINE* 9:9-11 from one of the Dead Sea Scrolls as follows:

"They shall depart from none of the councils of the Law to walk in the stubbornness of their hearts, but shall be ruled by the primitive precepts in which the men of the community were first instructed until there shall come the Prophet and the Messiahs of Aaron and Israel."

Certainly the Essenes were looking for three celestial events, the sign of the Prophet and the signs of the TWO MESSIAHS. Of course this passage means nothing to those scholars who understand there to be only the one Messiah of the New Testament. Other passages in the text refer to the child of the virgin Mary to be called the "Son of the Most High" and "Son of God" and "His kingdom shall be forever". For the first time these similar passages found in the Luke gospel at the annunciation to Mary by the Angel Gabriel, occur in a Palestinian text outside the Bible. The Luke gospel was written in Greek and these passages were written in Aramaic, the language of Christ and the Essenes, but the meaning is exactly the same. Here in the two Messiahs of the Essenes lies the mystery of the two Jesus children.

Probably the most remarkable esoteric secret revealed by Steiner was the story of this mystery. The Bible hints several times to the genealogy of the Messianic line coming from the House of David. However, outside the Bible in texts and archeological remains, there really is no other mention of this term, the House of David, as an historical entity. King David had two sons, Solomon and Nathan. The Nathan line was the priestly line referred to in the Books of Enoch and the Essene scroll as the Messiah of Aaron and into which we saw the incarnations of Phinehas and Elijah. The genealogy of this line is preserved in the Gospel of St. Matthew. The Messiah of the kingly line is referred in the Old Testament Psalms and the genealogy of the Nathan line is reflected in the gospel of St. Luke. Commentators have tried for centuries to reconcile these two Gospel accounts of the House of David as well as the infancy stories of Jesus. Now the conflict can be resolved by the secret of the birth of two Jesus children, one born as reflected in the St. Matthew Gospel and one born as reflected in the gospel account given in St. Luke.

The genealogy given in the St. Matthew gospel goes back to the beginning of the Hebrew nation in Abraham and the blood line established through his son Isaac. The key is the 3 X 14 blood line generations as an historical preparation of the physical, etheric and astral bodies of members of the Jewish race as a vehicle suitable to bear the ego incarnation of the Christ when He appeared. This evolution from Abraham to Jesus proceeds thru three stages as described in the gospel. The first stage was the 14 generations from Abraham to the Kings as a preparation of the physical body; the second was the 14 generations from the Kings to the Babylonian Captivity as a preparation of the etheric body and the third was the 14 generations for the astral body lasting a Neros from the Babylonian Captivity to the birth of the Solomon child as an incarnation of Zarathustra. This is why the Magi, who were looking for their Naros, accepted the birth of the Bethlehem child as Zarathustra. This great Naros had in former times sacrificed his etheric body and gave it to Moses and also sacrificed his astral body and passed it over to the Egyptian Hermes, both great initiates and founders of cultural epochs. Now in this incarnation, this great initiate gave his fourth principle or ego to the Bethlehem child of the St. Matthew Gospel. (It is interesting to note the Vatican frescoes painted by Pinturicchio for Pope Alexander VI in which one scene shows IO-Isis seated with Hermes Trismegistes, as law giver to the Egyptians and also seated with Moses as law giver to the Jews. Hermes was called the Egyptian Moses and this series of paintings was inspired by the Hermetic-Cabbalistic writings of Pico Della Mirandola, who undoubtedly knew of the Hermes-Moses connection.)

The genealogy of the St. Luke Gospel goes back 77 generations to Adam and Eve, the original ancestral parents of Genesis. Steiner says that there existed an original Adam-soul that had been preserved in the Great White Lodge by the great sun initiate, Manu. The character of this soul was such that it had waited the longest to incarnate on earth so that it represented an Adam-soul as it was before the "fall", dating back to the ancient age of Lemuria. This soul was young and pure and had not been burdened by repeated earth lives. Only such an innocent soul could later unite with the Nirmanakaya of the Buddha. This ancestral soul was incarnated into the Nathan Jesus child of Nazareth born to a young mother.

Very supportive of this genealogy of the two Jesus children is the testimony of sister Anne Catherine Emmerich taken from her LIFE OF THE BLESSED VIRGIN MARY as follows:

"I saw the line of descent of the Messiah proceeding from David and dividing into two branches. The right hand one went through Solomon down to Jacob, the father of St. Joseph. I saw the figures of all St. Joseph's ancestors named in the Gospel on this right-hand branch of the descent from David through Solomon. This branch has the greater significance of the two; I saw the line of descent issuing from the mouths of the separate figures in streams of white colorless light. The figures were taller and looked more spiritual than those of the left-hand line. Each one held a long flower stem with hanging leaves like those of palms: this stem was crowned with a great bell-shaped flower shaped like a lily and having five stamens, yellow at the top, from which a fine yellow dust was scattered. These flowers differed in size, vigor, and beauty. The flower borne by Joseph, the foster-father of Jesus, was the most beautiful and purest of all, with fresh and abundant petals. Halfway down this ancestral tree were three rejected shoots, blackened and withered. In this line through Solomon there were several gaps separating its fruits more widely from each other. The right-hand and left-hand branches met several times, and they crossed each other at a point a few generations before the end. I was given an explanation about the higher significance of the line of descent through Solomon. It had in it more of the spirit and less of the flesh, and had some of the significance belonging to Solomon himself. I cannot express this.

The left-hand line of descent went from David through Nathan down to Hell, which is the real name of Joachim, Mary's father, for he did not receive the name of Joachim till ~1 S later, just as Abram was not called Abraham until later. I forget the reason, but it will perhaps come back to me. In my visions I often hear Jesus called after the flesh a son of Heli.

I saw this whole line from David through Nathan flowing at a lower level: it generally issued from the navels of the separate figures. I saw it colored red, yellow, or white, but never blue. Here and there were stains; then the stream became clear again. The figures upon it were smaller than those of the line through Solomon. They carried smaller branches which hung down sideways and had little yellow-green leaves with serrated edges; their branches were crowned with reddish buds of the color of wild roses. These were always closed; they were not flower-buds but the beginnings of fruits. A double row of little twigs hung down on the same side as the serrated leaves. At a point three or four generations above Hell or Joachim, the two lines crossed each other and rose up, ending with the Blessed Virgin.' At the point of crossing I think I think I saw the blood of Our Lady beginning to shine in the stream of descent."

A chart of this Solomon-Nathan genealogy is shown in the front of vol. I of her LIFE OF JESUS CHRIST.

Although she never spoke of the two separate Jesus children in her visions, it may be presumed that it was not the time for this revelation until the 20th century. She definitely had the material, but chose to remain silent about this greatest of all mysteries.

Thus, born into the era of 3 to 1 B.C. were three great persons, St. John the Baptist and the two Jesus children. (see the painting of Raphael of the Madonna del Duca di Terranuova with St. John the Baptist and the 2 Jesus children). The prophecy of the Teacher of Righteousness as the Bodhisattva Jeschu ben Pandira concerning the coming of the two Messiahs and the prophet had come true. The priestly Messiah of Aaron was the Nathan Jesus child. The kingly Messiah of Israel was the Solomon Jesus child.

There also were two couples named Joseph and Mary. The child of the Solomon line was born in Bethlehem and the child of the Nathan line was born in Nazareth and travelled to Bethlehem "to be taxed" as described in the St. Luke Gospel.

Twelve years later on the way to the Temple, thru an occult process, the Zarathustra ego of the Solomon child passed over into the bodily sheath of the Nathan child. This was why at the presentation at the Temple, the parents could not recognize the child (see the painting of the 2 Jesus children in the temple by Borgognone).. It was the wisdom of the Zarathustra ego residing in the body of the Nathan Jesus child speaking to the Rabbis and scribes. and the painting of Defendante Ferrara circa 1526 of the Jesus child in the Temple. (In addition, see the painting by Leonardo DaVinci called "the Virgin of the rocks." What is interesting here is that the staff of the child represented to be that of St. John the Baptist was ADDED after DaVinci painted it. This photo is from the London Gallery, where I have seen it. There is another version in Paris to which the staff was not added. To me this is a very clear example of a painting of the "two Jesus children" by a Renaissance adept that has been touched up to redirect the traditional sensibilities of the public.)

After this occult process occurred, the health of the ego-less Solomon Jesus child declined rapidly and he thereafter soon died. Likewise, the young mother of the Nathan Jesus child, who had no other children, soon died. The Joseph father of the Solomon child was very old, and prior to the presentation in the Temple, he died. Then, the mother of the Solomon child married the Joseph of the Nathan child and she took Jesus and her other children to the house of the Nathan Joseph where they lived together as a family in Nazareth. The Nathan Jesus child became to be known as Jesus of Nazareth and he bore the etheric body of a pre-Adamic soul, the astral body as Nirmanakaya of the Buddha and the ego of Zarathustra. In this way there occurred a complete fusion of Buddhism and Zoroastrianism in the Hebrew blood line.

The historical truth of this family arrangement was preserved by Epiphanius (b.315 A.D.) in his HISTORY OF JOSEPH THE CARPENTER. He relates that Joseph had six children by his first marriage, four sons named Jacob, Joseph, James and Simon, and two daughters named Assia and Lydia. He was a widower many years before he married the Solomon Jesus mother and he lived 111 years. Profoundly, Epiphanius also says that Joseph was the son of PANDERA, the exoteric Talmud name of the Bodhisattva Jeschu ben Pandira. This appears to be another secret in the Essene tradition that even Steiner does not speak of. If Joseph lived 111 years as historically stated and died before the presentation in the Temple at 12 A.D., he would have been born about 100 B.C. which is the date established by Steiner for the time of Jeschu ben Pandira.

The eldest son of Joseph named Jacob, a Nazir, became the first Christian Bishop until he was martyred by Jewish zealots about 63 A.D. Of the two sisters referred to in the New Testament as Miriam and Solome, Salome was said to be a sister of Mary the mother of Jesus and she was present at the crucifixion and afterwards visited the sepulcher.

Another riddle solved by the mystery of the two Jesus children concern the so-called massacre or slaughter of the innocents as related by the St. Matthew Gospel. Historically, the Magi appeared soon after the birth of the Solomon Jesus child and Herod ordered the slaughter of the innocents after his consultation with the Magi about the great astronomical events that occurred in the heavens. Why then did St. John the Baptist escape death if all other children under two years old, "that were in Bethlehem and in all the coasts thereof" were murdered? Steiner says that the Solomon Jesus child was born first in time was taken to Egypt by Joseph and Mary before the slaughter. Then, after the massacre and the death of Herod, St. John the Baptist and the Nathan Jesus child were born. Although Steiner says that these births were only a few months apart, we know from the St. Luke Gospel that this would have to be at least six months later, since Elizabeth was six months pregnant at the time of the visit of Mary and the Annunciation (see Duccio d. 1318) by Gabriel.

THE LAW OF TWELVE

1. CHRISTIAN ROSENKREUTZ

In his book *Esoteric Christianity* R. Steiner carefully weaves a story about the occult life of Christian Rosenkretz and his council of twelve members. In an unnamed place in Europe a spiritual lodge of twelve men was formed each of which had received into themselves the sum total of the spiritual wisdom of ancient times.

The council consisted first of the seven Hindu Rishis of the first cultural epoch designated the Indian. These Rishis were the great teachers of the Hindu Brahman culture now ascended as stars in the great Bear star foci.

The second part of the council consisted of four members each representing the acquired wisdom of each of the post-Atlantean cultural epochs designated as Indian, Persian, Egyptian-Chaldean and Greco-Roman.

The four joined the seven Rishis as incarnations in the thirteenth century. To this group a twelfth was added representing the wisdom of the then existing sciences. As Steiner says:

"By means of certain occult processes, the wisdom that had passed over from Atlantis to the holy Rishis had been transmitted to seven of these twelve men. In four others lived the wisdom of the sacred mysteries of the Indian, Persian, Egyptian and Greco-Roman epochs respectively, and what existed in those days of the kind of culture which was to characterize the fifth post-Atlantean epoch constituted the twelfth. The whole range of spiritual life was accessible to these twelve."

Into this council of twelve a child, a former contemporary of Christ, was incarnated. The council took this child into their care and instructed him in all their knowledge and wisdom so that all the wisdom of the preceding cultural epochs rayed into his soul. For the first time, the twelve great sources of wisdom and religion were united into this child in one interconnected unity. After his early death and subsequent incarnation in the fourteenth century, this child became known as Christian Rosenkretz and his mystery stream of esoteric Christianity called the Rosicrucian. For our purposes, what is important here is that Steiner states the obvious, "Christian Rosenkretz was the thirteenth in the circle of twelve."

What is the occult significance of this relationship of a circle of twelve around a thirteenth who acts as a spiritual leader of mankind? Obviously, there is a correspondence to Christ and the twelve disciples.

2. MOSES AND CHRIST

The tasks of Moses were many. On one level, he was the ordained bearer of the "I am that I am" ego principal. By leading the Jews out of Egypt, he severed the ancient clairvoyant consciousness, representative of the Indian, Persian, and Egyptian cultural epochs and created in his Hebrew sub-race in exile, the germ of a new ego intellectuality necessary to be developed in the subsequent fourth cultural epoch commencing in the year 747 B.C. On another level, he was ordained to instruct and cultivate in his Hebrew sub-race the Messianic tradition for the coming of the birth of Christ. Imaginatively, I have felt that the 40 year journey of Moses and the Jews through the desert represented in the microcosm, the cosmic journey in the macrocosm of Christ descending as a Spirit of Wisdom through the forty circles of the Zohar and the corresponding spiritual hierarchies of galaxy, zodiac, planets, and sun to be incarnated on earth as the redeemer of mankind.

In the ordained tasks of Moses we also observe numerous references to this mysterious correspondence of twelve-foldness. For example, there is Jacob and his sons, the twelve tribes of Israel; the twelve Judges of Israel, starting with Othniel and ending with Samson; the twelve scouts sent out by Moses into the desert at the beginning of exile; the twelve cakes of the Shewbread are the twelve precious gems in the breastplate and ephod of the high priests. Several authors relate the twelve tribes or Israel with an intentional plan by Moses to correspond with the twelve signs of the Zodiac, a sort of earthly recapitulation of the celestial zodiac signs. However, no author other than Emil Bock has ventured to state with certainty from spiritual research that there is a correspondence between the celestial star foci and the occurrences of twelve in the Hebrew-Moses lineage. Obviously, I concur with his conclusion at the end of *Moses* by Emil Bock.

"Joshua, the twelve judges of Israel, and Ruth, together appear as a pre-configuration of the same celestial configuration, which later found a fulfilled reality on earth as Jesus of Nazareth, the twelve disciples and Mary. The judges whose twelve-foldness is made visible in a conscious manner of composition appear as a circle of representatives of humanity. Later on, the twelve apostles drew the circle of mankind around the Christ figure. We may discover the heavenly configuration which fashioned their preparatory and fulfilling human reflection around the Christ being, who represented the central point like a brightly shining spiritual sun, the twelve Bodhisattva's figures were gathered in a circle in the spiritual works during the pre-Christian evolutions of humanity. They comprised the sphere of guidance out of which the destiny of earthly man received its direction in nations and culture. The figures of Joshua, the twelve judges and Ruth placed together by the canon of the Old Testament, thus create a bridge from the celestial circle of the Bodhisattva's to the apostles circle on earth."

This is a remarkable statement by a respected Biblical scholar and student of spiritual research which confirms my research in spiritual geometry.

3. OCCULT TWELVE-FOLDNESS

From my research, Bock is the first person to imagine in the circle of twelve judges and the circle of the apostles a shining spiritual sun as the thirteenth, obviously similar in all respects to the council of twelve and the thirteenth as Christian Rosenkreutz. This certainly establishes an occult principal of twelve-foldness for spiritual leaders.

More importantly, Bock also sees an additional occult principal when he corresponds the circle of spiritual twelve-foldness with actual celestial Bodhisattva's existing in space as physical entities of stars and suns. This equation is an ancient one. For example, the Hindus have believed for thousands of years that the seven Holy Rishis have ascended in space and reside in the seven stars of the Great Bear (Big Dipper) constellation. Likewise, in theosophy texts, Buddhist texts and the Secret Doctrine, many examples are given of celestial Bodhisattva's residing in space who have physical counterparts on earth. Madame H.P. Blavatsky states,

"In the Northern Buddhist system, it is taught that every Buddha, while preaching the good law on earth, manifests himself simultaneously in three worlds: in the formless, as Dhyana-Buddha, in the world of Forms as a Bodhisattva, and in the world of desire (earth) as a man...The star under which a human entity is born, will remain forever its star, throughout the whole cycle of its incarnations in one manvantara. The angel of that star, or the Dhyani-Buddhi, will be the guiding angel in every new rebirth of the monad."

Thus, (1) every human on earth has a spiritual counterpart in cosmic space residing in its personal star; (2) the movements and groupings of humans on earth have corresponding celestial movements in cosmic space; (3) the most significant spiritual events on earth that occur through human incarnations such as Moses, Buddha and Christ involve a certain twelve-foldness around a thirteenth spiritual sun.

Many other examples of twelve-foldness abound from religions sources such as: Mohammed and the twelve successor Iman's of Shi'ite Islam; King Arthur and the twelve knights of the round table; Guru Nanak and his twelve successor gurus (although actually terminated at the tenth); Mahavira and his twelve disciples called Ganadharas; the Persian Khwajagan (masters of wisdom) and twelve successors to Yosof of Hamadan; Odin and his twelve Drottes (priests); and Joseph of Arimathea and the twelve sons of Hebron. In addition there is the 12 chapters of the LAWS OF MANU; the 12 great circle of the circular council of the Dalai Lama; the 12 disciples of the Lao-tzu; the 12 judges of the Egyptian book of the Dead; the 12 main Aesir and their dwellings or thrones in the Nordic tradition; the 12 Palatines of Charlemagne; the 12 labours of Hercules; the 12 days in Siegfried's journey and in the 12 kings subjected to him and the 12 lictorians begun by Romulus.

What is the common thread of this spiritual twelve-foldness around a spiritual sun that has correspondence in both the microcosm on earth and macrocosm of celestial space?

4. TWELVE-FOLDNESS OF THE ZODIAC

Although referred to as a fixed star, our sun has an apparent eastward motion through the celestial sphere of the Milky Way galaxy. This eastward motion describes a great circle called the plane of the ecliptic. Imagining the ecliptic as the equator of the celestial sphere, the zodiac is a band of star constellations, the width of which is thirty degrees above and below the plane of the ecliptic. Our sun passes through this band of the zodiac on its motion through celestial space.

It is important to observe the zodiac as a BAND of stars in twelve signs and not twelve points around the central sun. Twelve points around a central sun imparts a different concept, that of a polyhedron instead of a flywheel or bicycle rim.

Not a point, the zodiac is a band thirty degrees high and low in declination and a varying magnitudes in width. Because of its length and width, the zodiac as a band of stars can be imagined as a flywheel and bicycle rim. First, consider the zodiac as a flywheel of a gyroscope with a ring of twelve balls. In Plat No. , each ball is considered as a separate band of the zodiac, twelve in all. If set in eternal motion at great speed, it becomes like a disc with a central axis imagined like the sun. The disc acts like the flywheel of a gyroscope. Precession is the motion effect of a body in motion upon another body in motion. Gravity forces have a 180 degree circumferential effect which produce a 90 degree precessional effect on bodies in motion. This is how a gyroscope spins and moves, when downward pressure is applied to the edge of a gyro flywheel, its plane of rotation tilts along a horizontal axis created at the point of force. Or, when pressure is applied to the axis of rotation, the plan of rotation of the flywheel tilts precessionally. Therefore, both the axis and the flywheel tilt at right angles (90) to the point where the force is exerted. This 90 reaction is the precessional effect.

In our imagination of the sun as the axis of a gyro, whose flywheel is the band of the zodiac, any pressure exerted on the flywheel would cause the axis of the sun to rotate at 90 precessionally. This explains why the sun as a fixed star can rotate in space on its axis.

Second, consider the zodiac as a bicycle rim composed of twelve spokes of the zodiac directed from a central hub. As shown in Plat No. , many spokes are needed to keep the rim from bending outward while the weight load is suspended in the center hub. The vertical spokes leading from the hub to the rim fix the weight load and keep the hub from twisting in place or oscillating as a drum head. Buckminster Fuller discovered that it takes a minimum of twelve spokes to fix the hub in relation to the rim. Any fewer spokes would cause the hub to twist in and out of place and with sufficient weight on the rim, cause the hub to collapse. All spokes in excess of twelve strengthen the wheel.

Imagine now the sun as the hub fixed in place by the twelve spokes of the zodiac. Twelve stars representing the zodiac is the minimum, but we know each band of the zodiac consists of eight to fifteen or more representative stars, thus making the cosmic wheel stronger than the minimum. With each band of the zodiac partitioned into sextants of thirty degrees each, there is plenty of room to all additional spokes represented as new stars (such as that new star of the magi appearing in Pisces).

B. Fuller has similarly observed the hub-rim, tension-compression aspect of the sun and zodiac.

"As I considered the twelve unique vectors on freedom constantly and nonredundantly operative between the two poles of the wire wheel - its islanded hub and its islanded equatorial rim-atoll, in effect a Milky Way-like ring of a myriad of star islands encircling the hub in a plane perpendicular to the hub axis - I discerned that this most economic arrangement of forces might also be that minimum possible system of nature capable of displaying a stable constellar compressional discontinuity and tensional continuity."

He goes on to say that a one-island system such as our sun could not exist without the tensional forces as represented by the twelve or more spokes of the zodiac. To think that the hub or rim could exist without each other is an "optical illusion" caused by our scientists inability to perceive the invisible level of atomic structuring.

Also, Plat No. shows a vertical slice of the cosmic wheel. The hub actually appears as an elongated axis which can have a hollow space located within it. With the sun as hub, the spiral motion in eternity of the sun in its journey through space describes the fixed hollow hub. Within this hollow hub is our solar system of planets with motions independent of the zodiac.

In conclusion, it takes a minimum of twelve spokes to fix a hub in relation to the rim. This is the first instance of twelve-foldness in our macrocosm extending from zodiac to the earth. The twelve-foldness of the zodiac can be considered in two aspects. First, as the flywheel of a gyroscope with a central thirteenth sun. Second, as the rim of a cosmic wheel with a fixed solar hub in the center. In either case, in our macrocosm, **THERE COULD BE NO FIXED STAR AS CENTRAL SUN WHICH COULD SUPPORT A PLANETARY SYSTEM WITHOUT THE TWELVEFOLDNESS OF THE BAND OF THE ZODIAC.**

5. TWELVE-FOLDNESS OF THE METALS

With the exception of the free gases in the atmosphere, only about twenty elements are found in the native state.

These elements are divided into metals, semi-metals and non-metals. The three active metal groups are the gold group consisting of gold, silver, copper and lead; the platinum group consists of platinum, palladium, iridium and osmium; the iron group of iron and nickel iron. The semi-metals and non-metals do not concern us here.

Approximately two-thirds of the metals fall into the class of non-directional bonds and their crystal structure can be described by spheres in "close-packing", which in their case, each sphere contacts twelve others. Here is the (FCC) twelve-foldness of the microcosm of atomic elements.

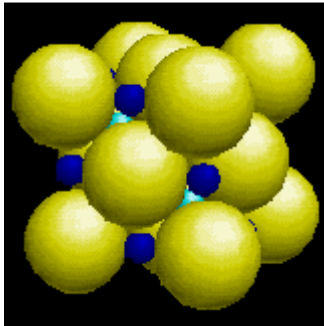

Taking the so-called gold group, we see similar chemical properties arising from similar structure. All are rather soft, malleable, ductile and sectile. All are excellent conductors of heat and electricity, display metallic luster and hackly fracture and have rather low melting points. In addition, because of the twelvefold close-packing, all have

isometric hexoctahedral crystal structure with unusually high densities. This tight close packing allows the smallest interstices between atoms and contribute to the directional flow of electrons for the conductivity of electricity, which no other elements share. Finally, the colors of the elements outside the gold group are diffused in their combinations with other elements. However, the yellow of gold, the red of copper, the white of silver and the blue of lead are all inherent atomic properties.

Wilhelm Pelikan in his book, *The Secrets of Metals*, discusses the spiritual genesis and qualities of the seven ancient metals and their relationship with the seven ancient planets.

Lead to Saturn influences;

Tin to Jupiter influences;

Iron to Mars influences;

Gold to Sun influences;

Copper to Venus influences;

Mercury to Mercury influences; and

Silver to Moon influences.

The metals of our gold group would compose the quaternary of the sun and the planets of Saturn, Venus and Moon.

The elements tin, iron, mercury would fall out of this quaternary as their atomic coordination structure is respectively fourfold, eightfold. The occult relationship between the planets and the native metals is the transmission of forces or influences and, obviously, a native element such as silver transmits forces more efficiently than a non-metal element such as potassium. Thus, the earth in its geological evolution has become a depository of the native metals for the earth to act as a bell in sounding the music of the planetary spheres.

The twelve-Fold coordination of the atomic structure of the gold group displays this occult principal at work in the microcosm. In crystallography, the face-centered cubic lattice (FCC) is the equivalent to cubic close packing (CCP).

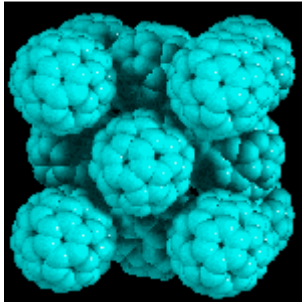

This lattice is defined by fourteen spheres, eight at the vertices and six at the faces as in Plat No. . Note that the stacking is in layers of five on

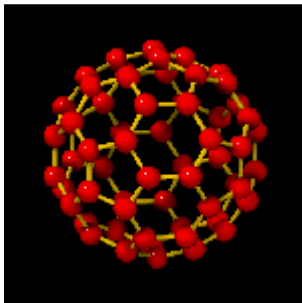

the face, four in the center and five on the face or $5 + 4 + 5 = 14$ spheres. Although it has not been proved that this is the greatest density possible for sphere packing, no other packing of equal spheres has shown a higher density. It will be shown later that there are several possible arrangements for twelvefold sphere packing, such as cuboctahedron, icosahedron and rhombic dodecahedron. The FCC packing is the most dense in nature.

In conclusion, we saw in the zodiac, the first instance of twelve-foldness in the macrocosm, with the hub-rim twelve-foldness of the sun and the zodiac, spread out like islands of tension-compression in the ocean of cosmic space. Here, twelve-foldness is the minimum to support stellar structure. In the native metals, we see the first

instance of twelve-foldness in the microcosm. Here, twelve-foldness is the maximum in atomic close packing wherein each atom is in personal contact with each other atom. This relationship produces unique results by carrying planetary influences, especially the conduit of electricity from the central sun. In both macrocosm and microcosm, we see the principal of twelve around one, with an occult reversal of expansion in the zodiac and contraction in the atoms of the native metals.

6. HEXOCTAHEDRON CRYSTAL CLASS

Diverging from our discussion of twelve-foldness, it is interesting to see how the soon to be called "Law of Twelve" relates in the microcosm with the precessional effect of the Law of Three and the Law of Seven.

The gold group belongs to the isometric crystal system, one of SEVEN structural systems in crystallography. Within this system, is a crystal class called the hexoctahedron, whose symmetry symbol is $4/m\ 3\ 2/m$. The hexoctahedral crystal form consists of three axes of fourfold symmetry, four diagonal axes of threefold symmetry and six diagonal axes of twofold symmetry as shown in Plat No. . Thus, a total of thirteen axis of symmetry. This symmetry is the highest possible in crystallography.

This hexoctahedral form produces or precesses SEVEN isometric crystals as follows:

Form Faces

cube -----6

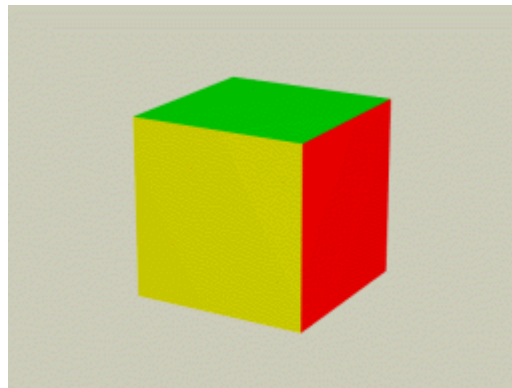

rhombic dodechedron ---- 12

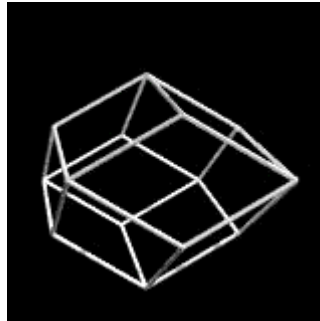

octahedron ----- 8

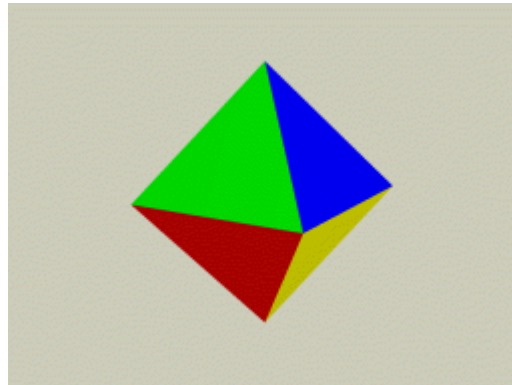

Tetrahexahedron ----- 24

Trisoctahedron ----- 24

Trapezohedron ----- 24
Hexoctahedron ----- 48

All of the above SEVEN forms are produced by rotation, translation and truncation (of tetra) processes of THREE fixed forms of cube, octahedron and rhombic dodecahedron. Thus, the three process and produce the seven which process and close pack in twelve-foldness, creating the gold group with: (1) highest crystal symmetry in nature, and (2) the most dense close packing in nature to carry the life force of nature, electricity or Fohat.

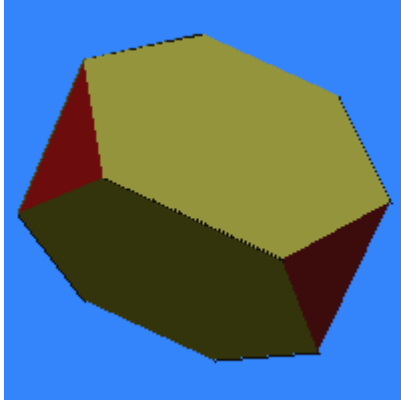

7 EVOLUTION OF SPHERE POINTS

There are several different models of twelve-foldness, such as the pent-dodecahedron, the icosahedron and the rhombic dodecahedron. However, there is only one nucleated twelve-foldness of twelve around one and this was rediscovered by B. Fuller. To discover this unique structure, follow the evolution of basic sphere point configurations.

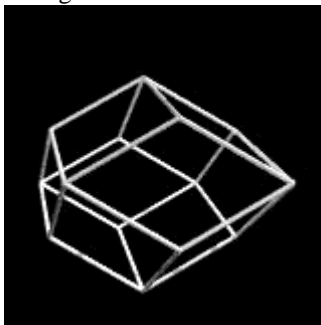

In Plat No. , we see that four spheres are the greatest number that can be in simultaneous contact and this produces the tetrahedron .

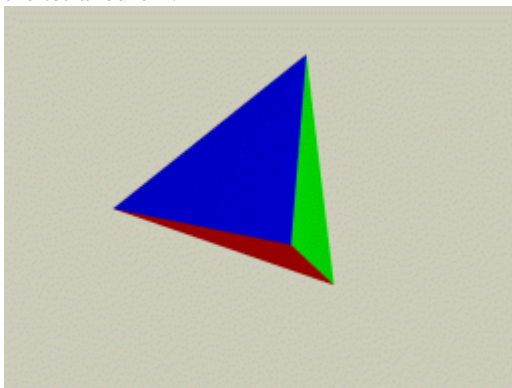

By successively adding spheres into the interstices (the valley between spheres), we find a hierarchy of five regular solids from three triangulated close packings of equal size spheres. A second set of four spheres also produces a tetrahedron. Thus, it is its own dual .

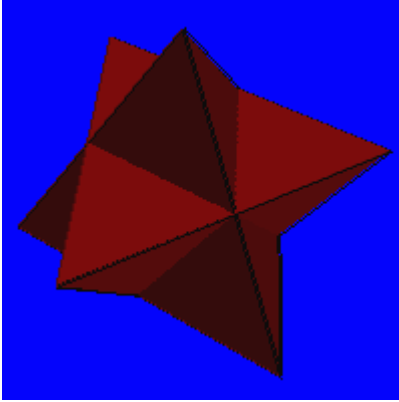

Six spheres produces an octahedron with each sphere touching four others (four-foldness).

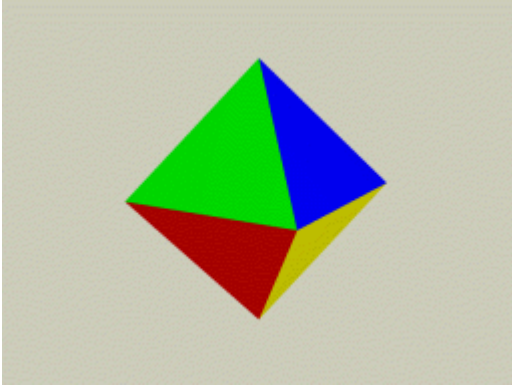

Adding a third set of set of spheres to the octahedron, a cube is produced.

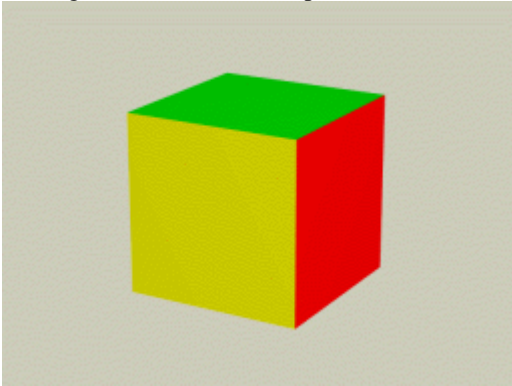

Thus, the cube is the dual of the octahedron.

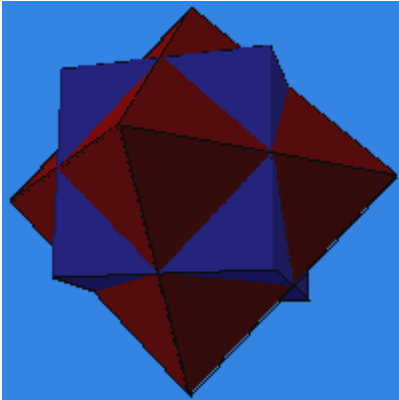

This cube also represents cubic close packing and consists of fourteen spheres as in the fourteen atoms in the close packing of the native metals. However, this close packing is inherently non-nucleated, there is no center nuclear sphere. If we rearrange the fourteen spheres of the FCC cube

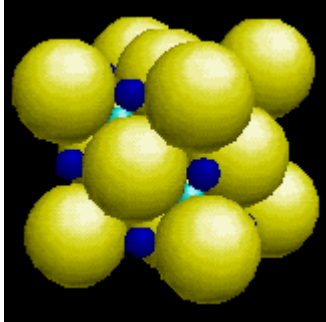

around a center nucleus, we obtain the cuboctahedron, which is twelve spheres around a central thirteenth and we have discovered our model of twelve-foldness around a central thirteenth.

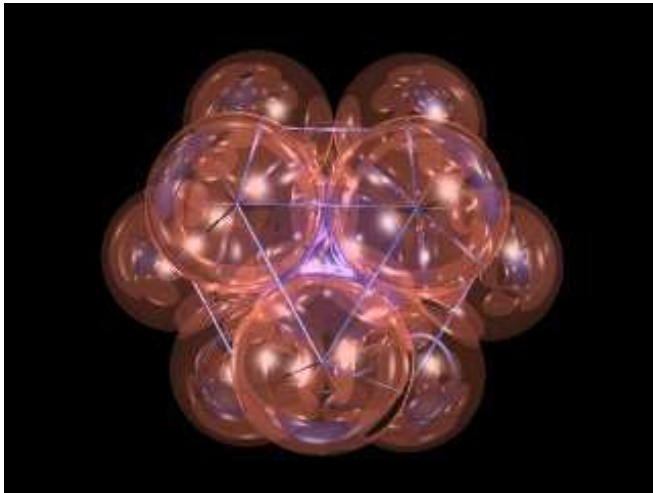

If the center or thirteenth sphere is removed, the cuboctahedron twists into an icosahedron.

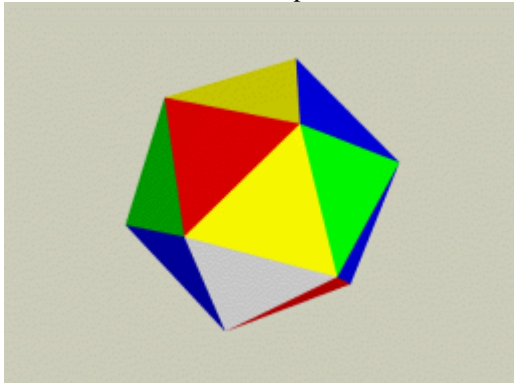

The twelve spheres in the icosahedron each touch five others (fivefoldness). If we add an additional twenty spheres to each of the twenty triangles of the icosahedron, we obtain the regular dodecahedron.

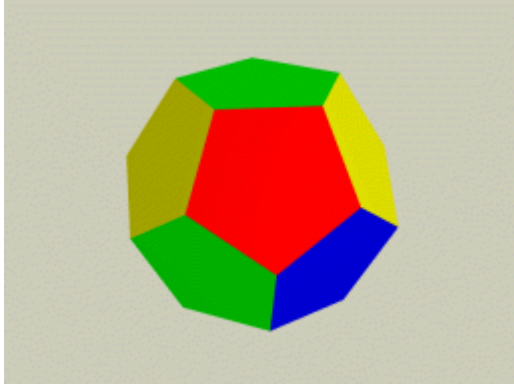

Thus, the dodecahedron is the dual of the icosahedron.

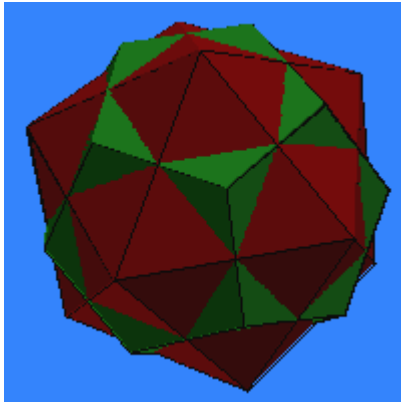

In all, this Concentric Hierarchy evolution discloses a hierarchy of five regular (Platonic Relationships) solids from the tetrahedron on (its own dual) to the octahedron, the octahedron to the cube (its dual);

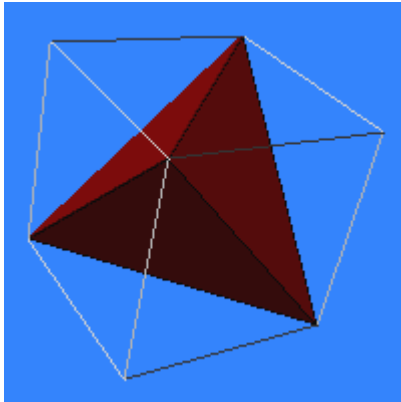

then after close packing the cube, from the icosahedron the dodecahedron (its dual).

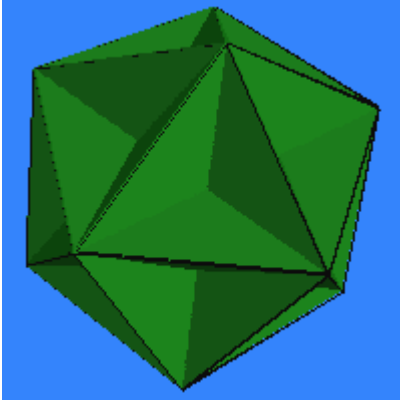

In the middle is our cuboctahedron ,

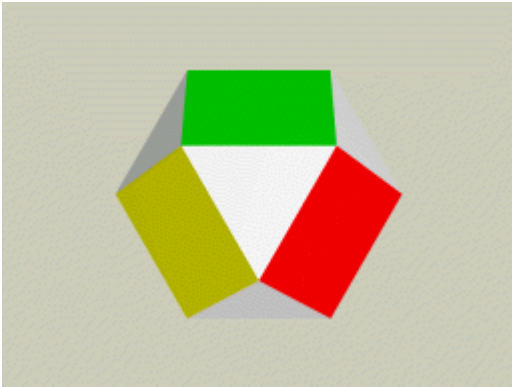

the only close packed nucleated solid. In conclusion, the evolution is summarized [HERE](#)

EVOLUTION OF SPHERE-POINTS

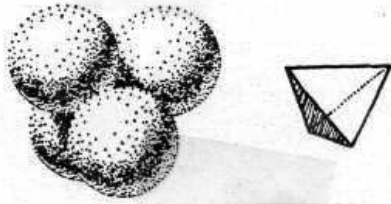

TETRAHEDRON - 4 SPHERES

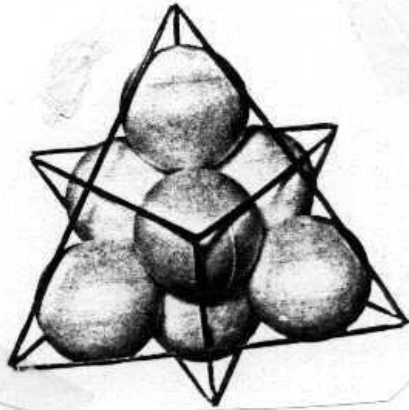

DUAL - 8 SPHERES

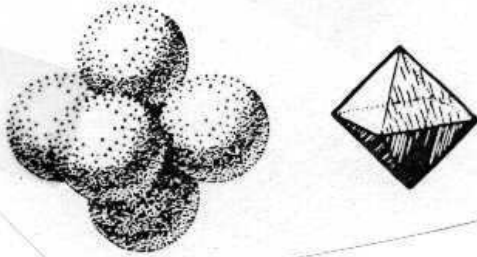

6 SPHERES - OCTAHEDRON

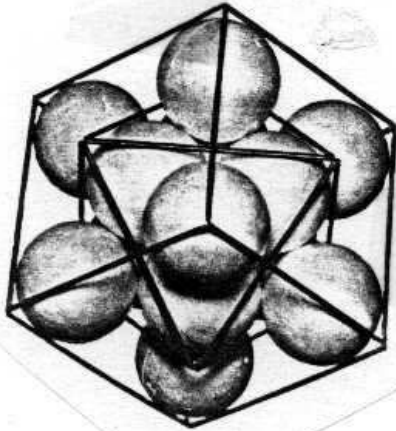

14 SPHERES - CUBE

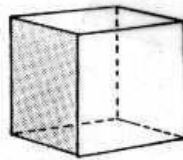

CUBE or CUBIC PRISM

CUBE IS DUAL OF OCTAHEDRON

and HERE.

EVOLUTION OF SPHERE POINTS

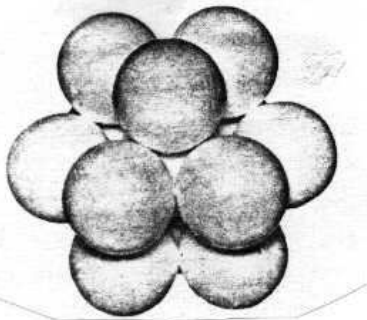

13 SPHERES - CUBOCTAHEDRON
WITH NUCLEAR SPHERE

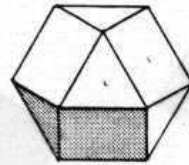

CUBOCTAHEDRON
or 'DYMATION'

TWISTS INTO
ICOSAHEDRON

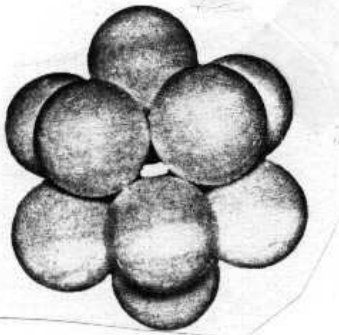

12 SPHERES - ICOSAHEDRON
NO NUCLEUS

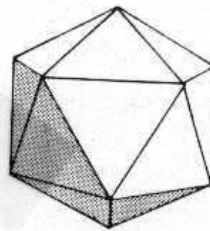

ICOSAHEDRON

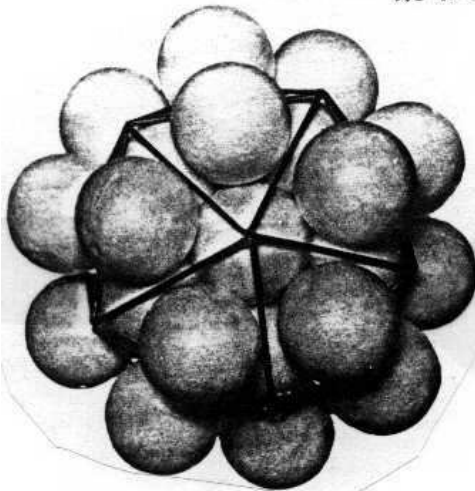

32 SPHERES - PENT. DODECAHEDRON

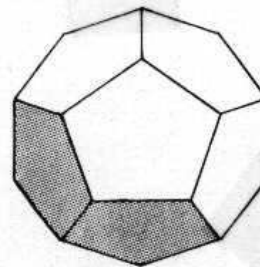

DODECAHEDRON is

DUAL OF ICOSAHEDRON

8 THE CUBOCTAHEDRON

The cuboctahedron is the most unique configuration in cosmos. The regular solids above described date back to Pythagorus and were first published exoterically by Plato in the Timaeus where he correlated them with the respective elements of fire, air, earth and water. The dodecahedron has been recognized by the most ancient Hindu culture in the zodiac as Makaram (Capricorn), the geometrical model initiated by the Demiurgus in constructing the

material universe. Likewise, St. John in the Apocalypse relates the twelve gates of the new Jerusalem to a celestial dodecahedron.

If the regular solids have been recognized for thousands of years, why has the cuboctahedron been hidden? Fuller says, "Being the zerophase of energy the (cuboctahedron) is inherently invisible and non-empirically discoverable, which accounts for its having been so long unrecognized."

Besides rediscovering the cuboctahedron, Fuller names it the dymaxion or vector-equilibrium. As a solid it consists externally as eight triangles and six squares .

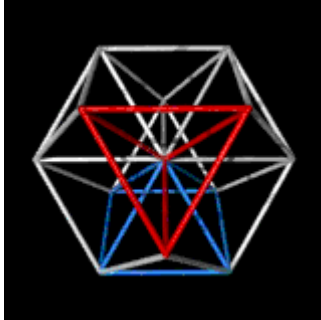

Using the tetrahedron as prime unity, it has a volume of twenty. Internally, the twelve vertexes extend in tangential radius from the original twelve spheres surrounding the nuclear sphere. The length of each of the twelve vectors extending from the center to the vertexes are all of equal length, thus, vector equilibrium.

The cuboctahedron also defines a sixty degree coordination system inherent in all cosmos. The western scientific tradition has adopted a ninety degree three dimensional coordinate system to describe nature. However, a sixty degree system operates circumferentially or radially and allows for modeling in dimensions beyond the third of traditional physics. At every internal convergence there are always twelve vectors coming together and they are always convergent at sixty degrees with respect to each other. In the future, all geometry will be based upon a sixty degree coordinate system.

Although one of the original 23 Archimedean solids, the cuboctahedron has had a long standing unrecognized past, even by crystallographers. I can find no crystal structure in any of the elements that even suggest this form. The other twelve vertexed solids such as icosahedron and pentagonal dodecahedron find themselves in nature as aluminum alloys (WAl and MoAl) and chlorine hydrate respectively. The reason for this is that the cuboctahedron is a system and not a structure. As a system it is the common denominator of the tetrahedron, octahedron and cube, representing the equilibrium of the outward radial thrust of vectors balanced by the circumferentially restraining chord forces. An omnidirectional equilibrium of forces of equal lengths in twelve-foldness. The tetrahedron is the prime non-nucleated system or volume in cosmos. As a structure, the Cuboctahedron exists not as itself, but only as a structure for close packing around a nuclear sphere. The cuboctahedron is the prime nucleated structural system of cosmos.

9 THE STRUCTURAL MODEL

We can now correspond the model of circle of twelve around a spiritual leader as thirteenth directly with the cuboctahedron. The circle is twelve for no other reason than the fact that twelve is the most that can be packed together wherein there is still personal contact between the center or thirteenth.

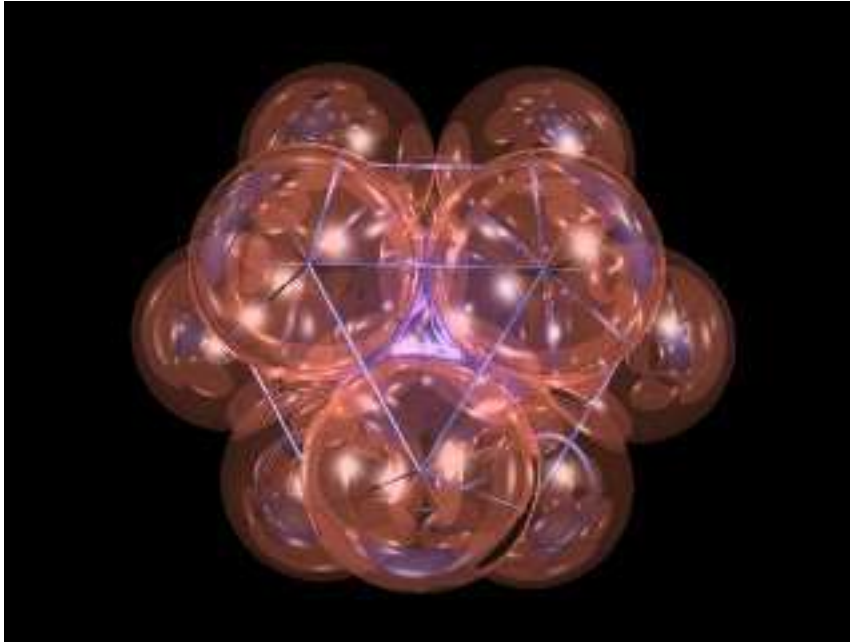

Only the cuboctahedron has a center nucleus. The other twelvefold regular solids as icosahedron and dodecahedron do not have a center sphere and therefore cannot serve as our model for twelve around one. However, there is a unique relationship between the cuboctahedron and icosahedron.

In our discussion of the evolution of sphere points, it was stated that the cuboctahedron twists into the icosahedron. This happens because as a system and not a structure, the cuboctahedron is inherently unstable. The only stable structure is an equilateral triangle, of which the cuboctahedron has eight.

However, it also has six squares faces which are unstable in relation to the triangles. When pressure is applied to the cuboctahedron, the square faces precess into the more stable triangular faces and the result is the twenty triangles of the icosahedron.

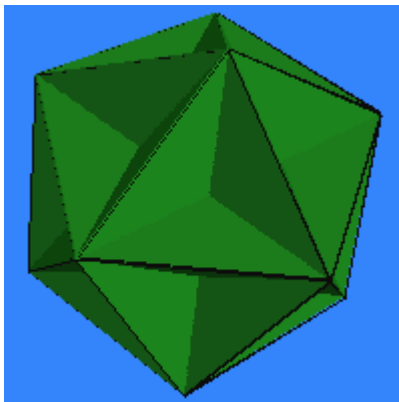

The tetrahedron, octahedron and icosahedron are the most stable structures in cosmos because they are all triangulated with no unstable faces composed of squares or pentagons, etc.

However, something is lost in the precession from cuboctahedron to icosahedron. The nuclear ball of the cuboctahedron DISAPPEARS as the final close packing of twelve spheres of the icosahedron is un-nucleated with no center.

This unique behavior also corresponds to our circle of twelve. The cuboctahedron represents the circle of twelve IN LIFE, with Moses, Buddha, Christ and Father C.R. surrounded by the twelve apostles. IN DEATH, the center spiritual leader DISAPPEARS from earthly existence but is survived by the circle of twelve now, in the form of an icosahedron. Therefore, in life, our circle of twelve exist in form as an cuboctahedron and in death, in form as an icosahedron, stronger, but with no nucleus.

To make this correspondence even more clear, R. Steiner in The Gospel of St. Luke says,

"A whole survey of earth evolution would reveal that there are twelve such Bodhisattvas...directing all earth evolution...if you were to look into the great Spirit-Lodge of the twelve Bodhisattvas you would find in the midst of

the twelve there is a thirteenth...There streams from the thirteenth what the others have to teach. He is that being from whom wisdom itself streams as very substance. It is quite correct to speak of the twelve Bodhisattvas in the great Spirit-Lodge grouped around one who is their center. This thirteenth is He whom the ancient Rishis called Vishua Karman, whom Zarathustra called Ahura Mazdao, whom we call the Christ."

In conclusion, we have answered the question of why the great spiritual leaders of mankind are closed with a circle of twelve. The answer is that they correspond the nucleated structural model of the cuboctahedron. No other model exists. As a structural model, it relates the heavenly configuration of the twelve Bodhisattva's around the central spiritual sun, so to say, written in the stars on the celestial background.

10. THE FOUNDING OF THE NEW MYSTERIES

All spiritual impulses are founded upon our model of 12 disciples around a central spiritual sun. A final example to be considered is unique to all of us in the 20th century, a great time to live and learn Spiritual Science.

Once before, on the evening of September 20, 1913, Dr. Steiner laid a foundation Stone (made of copper) into the hill at Dornach to celebrate the dedication of the completion of the Goetheanum. The holy stone was in the shape of a double pentagonal dodecahedron which he said " represents the striving human soul immersed as macrocosm in the microcosm." As opposed to the cuboctahedron, which represents a group of spiritual impulses, the similar 12-fold dodecahedron, represents "the cosmic image of the human soul." This building burned to the ground on New Years eve, 1922 and remarkably, the original foundation Stone survived. One year later, at Christmas 1923, Dr. Steiner held the now famous Christmas Foundation Meeting wherein he rededicated the Anthroposophical Society and the new Goetheanum. This monumental event is considered by many as a "cosmic turning point in time" and "a new cosmic age." Why this 12-fold shape to serve as the model of the new mysteries ?

As discussed in Esoteric Christianity in the DIONYSIUS meditation (supra), the four great mystery streams in the Western Tradition merged during the Christmas Foundation Meeting. Previously, those of the East and West merged in 869 AD by the Parsifal deed when he became the Grail King. The Eastern stream, representing the Buddhi impulse, consisted in those ancient mysteries of Atlantis carried forward by Hibernia-Celtic-Irish Christianity. The western impulse, representing the Manas impulse, consisted in those ancient mysteries of the post-Atlantean civilizations of the Hindu, Persian, Chaldean and Greek cultural epochs.

The Northern mystery stream was "polar" representing the hidden ego impulse and ancient sun wisdom of the second root race known as Hyperborea. Of all the mystery streams, only this center existed before the Fall, and its wisdom was preserved in the "traditional wisdom" so revered by our French intellectuals, Schuon and Guenon.

However, the ego impulse was held back from the following ages of Lemuria and Atlantis and preserved until Abraham appeared in the third sub-race of the Aryan root race. The Germanic tribes were directed thru the Trudi or Drotten mysteries to Scandinavia and Russia under the guidance of the bodhisattva Gautama Buddha, incarnated then as Odin. The Scythians were directed to Eastern Europe under the guidance of the bodhisattva Scythianos. The Southern mystery stream represented the preserved ancient mystery wisdom of the third root race, Lemuria, and came to Europe through the pagan Egyptian priesthood, the Old Testament Hebrews and later, thru Christianized Rome. The ego impulse first received its fullness with Moses, the I AM of the Old testament, and developed thru the 3 X 14 generations of the Matthew Gospel until the birth of Christ. Since then, the ego of Christ has been preserved in the Holy Grail chalice. During the Renaissance, the fully developed ego impulse of the Hebrews, passed over into the withheld ego impulse of the Celtic and Germanic tribes. This was made possible esoterically by the Rosicrucian impulse and exoterically by the Scholastic teachings of Albert Magnus and St. Thomas Aquinas. Beginning the 5th cultural epoch in 1413 AD, the united ego impulse civilized Europe with a Christian economy carried over from the Templars.

When the dark age of Kali Yuga lifted in 1899, individuals from all four mystery streams incarnated on earth to bring forth a united effort to commence the archangel Michael Age (1879). At the Foundation Stone Meeting in 1923 all four ancient mystery streams united, birthing forth a new spiritual being, the Michael inspired Spiritual Science of Anthroposophy. As such, esoteric Christianity, represented by Christian Rosencreutz, and exoteric Christianity, represented by Dr. Steiner, also united to give birth to a new Christian impulse, infused with revealed knowledge of karma and reincarnation.

Dr. Steiner's LAST ADDRESS given to members of the Society at Michaelmas 1924, further spoke of "four groups of twelve individuals." This archetype of 12, represents on the one hand, the impulse of love, as corresponds to the 12 petalled lotus chakra of the heart and on the other hand, the geometric form of all spiritual impulses. Although not specifically revealed by Dr. Steiner, the four groups of twelve represent the start of four new esoteric impulses replacing the four mystery streams that were merged during the Christmas Foundation Meeting. All of which incarnate in historical time with the commencement of the re-appearance or Second Coming of Christ in the etheric. Predictably, each group will incarnate on earth in a series of 25 years spread over the 20th century. Each group will have been prepared for its task in the sun sphere under the guidance of archangel Michael.

The task of each group of 12 will be to raise its group consciousness to the corresponding level of its guiding archangel, wherein the group can absorb the impulses for each of the four new mysteries. Who and where these centers are located is not known to me, but surely it relates to the incarnation of the three great teachers of the 20th century.

With Anthroposophy as the central spiritual being (that of the arch-angelic being of SOPHIA), the first great teacher was Dr. Steiner. The second great teacher is the incarnated Maitreya bodhisattva (previously identified as Jeschu ben Pandira in the first century BC) believed to be Valetin Tomberg. Each of these great teachers founded a path of spiritual training to reach its archangel. Steiner began the Esoteric School (1904-1914) and later the Free High School for Spiritual Science. The first fell by the path during WW I and the latter after his death in 1925. Tomberg began his Lord's Prayer course in Amsterdam between 1940-1942, but this was discontinued during WW II. However, his MEDITATIONS ON THE TAROT presents an individualised training for esoteric Christian Hermeticism and exoteric Catholic church practice of sacraments, penance and prayer.

The third great teacher may not become known as a public figure. During the LAST ADDRESS at Michaelmas 1924, Dr. Steiner mentioned the person of John the Baptist incarnating as the German Romantic poet, Novalis (1772-1801). From our NAROS meditation, we know of his Old Testament incarnation as Elijah, and previously as Phinehas, the son of Aaron the priest

In the GOSPEL OF ST. MARK, Dr. Steiner states that "the soul of John the Baptist, of Elijah, becomes the group soul of the twelve apostles; it lives and continues to live in the twelve", of course, after being beheaded by Herod. Then, "I have often maintained that the soul of Elijah-John appeared again in the painter Raphael." Thus, we see an evolutionary process of grounding of this great archangelic soul, first as the Hebrew group-soul/folk-spirit for the whole nation personified in Elijah; then, as the group soul for the twelve apostles and grounded further, in the individual souls of a painter and poet. His next incarnation should be as the third great teacher, grounding further in the last 1/3 of the 20th century.

When Dr. Steiner spoke of the spiritual impulse descending during the end of the 20th century, he spoke of the Platonic stream that had been held back from incarnation since the school of Chartres. Between the 12th century and now, the Aristotelian impulse of Albert Magnus and St. Thomas Aquinas was to lead a Christianised ego impulse into the 20th century where it cumulated in the Spiritual Science/Anthroposophy of Dr. Steiner.

Central to the spiritual impulse of Chartres was the Celtic cult of the black Virgin, the cathedral itself being built over the grotto of this ancient mystery center. It would seem most logical that the cosmic Christianity of the Celtic tradition, later revived by the Platonic teachers of Chartres, would incarnate at the end of the 20th century with an impulse dedicated to the Blessed Virgin. Thus, the third teacher would most likely be a woman teaching the wisdom of Sophia and founding a fourth new mystery stream dedicated to the Most Holy Trinosophia !

In conclusion, our model of the 12 around a spiritual sun, geometrically expressed in the cuboctahedron, has historically appeared thru the epochs of civilization, guiding the spiritual evolution of mankind and has re-appeared in the 20th century to birth the new mysteries, particularly, those of the Sophia Wisdom.

ANCIENT TWELVEFOLD WISDOM

1. Adjoining cosmoses

Plato says that God geometrizes and we say that he does so according to a twelvefold plan. The Law of Twelve introduces POLARITY into hierarchy of tenfoldness. Each hierarchy of ten is linked above to the higher plane with one pole and each hierarchy is linked below to the lower plane with one pole. Therefore, when one wants to consider relationships between successive planes or hierarchies, one must look above and below one level. This is what Gurdjieff means when he says,

"The conditions of the action of the laws on each plane, in each cosmos (hierarchy) are determined by the two adjoining cosmoses, the one above and the one below. Three cosmoses standing next to one another give a complete picture of the manifestation of the laws of the universe. One cosmos cannot give a complete picture. Thus, in order to know one cosmos, it is necessary to know the two adjoining cosmoses, the one above and the one below the first, one larger and one smaller. Taken together, these two cosmoses determine (the laws of) the one that lies between them."

Now, in speaking of the Law of Twelve, we are really speaking of an hierarchy (or cosmos as G. would say) of ten, with an upper link or pole binding it to the hierarchies above and the lower link or pole, binding it to the hierarchies below. The number twelve is not a principal in itself but a concept that links together the cosmoses both above and below. The importance of the Law of Twelve cannot be underestimated. It is both the end point and culmination of knowledge of the Laws of Three and Seven and as G. says the beginning point of science and philosophy, in the true meaning of these terms. P.D. Ouspensky also recognized the great importance of the teaching of the Law of Twelve which he expressed as his "period of dimensions."

The reason it is so important is that the study of the Law of Twelve has a synergetic effect in consciousness. As explained by G., typically a person is conscious of himself in only one cosmos or hierarchy and his spiritual or scientific investigation proceeds always in the direction of only one cosmos. However, if one proceeds in his investigation with the link to the upper and lower cosmoses, then one finds; first, a relation to itself in one cosmos; second, a relation to a higher or larger cosmos; and third, a relation to a lower or smaller cosmos. Thus, one investigates in a threefold synergetic way, effecting two other cosmoses simultaneously.

For example, I remember while in college the Voyager mission passing by the planet Jupiter. Now occultism and in particular a drawing by Robert Fludd relating the body of man to the planets, shows that Jupiter has rulership over, among other organs, the liver. At the same time that Voyager started transmitting back to earth pictures of Jupiter, an American scientist for the first time obtained an electron photograph of the liver or hepatitis virus and guess the correspondence! The electron photograph of the liver virus looked like the Voyager space craft and the Voyager space craft looked like the liver virus. Of course, since that time, electron photographs have shown that viruses resemble all sorts of space probe craft as well as the geodesic geometric structures discovered by B. Fuller. However this incident conclusively shows the synergetic principal that scientific investigation into the cosmos of the planets has a correspondence in the cosmos of the microbes. As above, so below, our isotropic principal operating simultaneously in three hierarchies.

2. Geocentric Astronomy

Nobody understood this principal of relating hierarchies both above and below better than the ancient occultists. Besides the flat earth theory of the Middle Ages, no other hoax has been as successfully perpetrated upon the Christian peoples than the so-called Geocentric theory as depicted by Ptolemy. We are still taught in school that the ancients thought the planets revolved around the earth until the discovery by Copernicus of the heliocentric theory. Nothing could be further from the truth. In fact, the earth centric diagrams of Ptolemy reflect the greatest wisdom of the ancients showing the earth and mankind in relation to (1.) a higher cosmos of the planets; (2.) an even higher cosmos of the zodiac and (3.) relation to the lower cosmos of the elements of fire, air, water and earth. The earth centric diagrams never intended to show the physical relationship of the planets but intended to show mankind's spiritual relationship with higher and lower the cosmos.

Plat No. shows the geocentric system of the ancients with the earth in the center of both the planetary cosmos and the zodiacal cosmos. The exoteric explanation given by the Church and modern science is that the ancients were really stupid! The esoteric explanation of the occultists is that of the path of the human soul during life after death! This is a foundation stone of western occultism, extending from Ancient Chaldea, Persia and Egypt, through Greece with Plato and Macrobius (exoterically), through the Christian mystery steams ending with the Rosicrucians and finally expressed in Masonic ritual as clearly explained by Albert Pike in *Morals and Dogma*. The geocentric spheres interpret as follows:

The galaxy crosses the zodiac in the two opposite points of Cancer and Capricorn. After death, the soul ascends through the planetary spheres in the order of Moon, Mercury, Venus, Sun, Mars, Jupiter and Saturn. During this ascent, the soul is cleansed of its past sins and karma. A passage must be made between the planetary world and the zodiacal world. The ancients called Capricorn the 'gate of man' through which passage was made from Saturn to the zodiac on the souls ascent to heaven. One of the ancient purposes of burnt offerings, blood sacrifice and prayer was to establish a relationship with a planetary spirit, whom after death, would guide and help the sacrificer find this gate quickly and safely.

If the soul is fortunate enough to pass through to the spirit-land of the zodiac, it finds itself merged into the much higher spiritual beings of the cosmos of stars. The passage of the soul through the twelve houses of the zodiac is a preparation of the soul for descent back through the planetary spheres to the next earth life incarnation. While the seed for the physical body is down on earth subject to the passions of love making rituals, the spiritual counterpart is carefully weaving a future etheric and astral body, drawing from the fine matter and forces of the starry cosmoses. The etheric body is the template of the physical body and during its composition and preparation for a new earth life, it draws certain forces from each of the zodiacal louses. The ancients represented this process in many ways, most often with the picture of a man impressed against the zodiac. While the soul is traveling through Aries, it draws the forces and starry matter necessary to construct the head and face template within the etheric body. For the other constellations, the general pattern is:

The melothesia

Taurus -----Neck, throat

Gemini -----Arms, shoulders

Cancer -----Chest, lungs, ribs, breasts

Leo -----Heart, diaphragm, back

Virgo -----Belly, intestines

Libra -----Navel, loins, kidneys, butt
Scorpio -----Gonads, bladder
Sagittarius -----Hips , thighs
Capricorn -----Knees
Aquarius -----Legs, ankles
Pisces -----Feet, toes.

When the preparation of the etheric body is complete, the forces of the moon draws the soul back on its descent through the planetary world. This passage from the zodiac is through the 'gate of the Gods' located in Cancer. The gate of Capricorn for the ascent and the gate of Cancer for the descent were called the "gates of the Sun" for two reasons. First, these constellations represented the tropical points in the suns travel along the plane of the ecliptic. Second, it was while the soul was in the sun that it found its spiritual helper (from the earthly sacrifices) who would travel with the soul as its guardian and helper in passage through the "gate of Men".

In the descent through the planetary spheres, the soul approaches each individual planet from the other side. What the soul experiences in these spiritual worlds is the reverse of what the soul would feel from earth with physical sight. In addition, the whole future earth life of the soul depends upon the relationship it establishes in these worlds in the course of its gradual descent to earth. For example, upon the planet Mercury, the soul makes its future connection with a particular nation or people with common language. On Venus, the soul makes its connection with a particular family. The last approach is to the moon sphere where the spiritual beings there are governed by that planetary spirit of the original Elohim of the Bible known as Jehovah. Here the soul decides its future sex. If the soul approaches the earth at the time of a full moon, it will become attracted to a female body. If the approach is at the time of a new moon, the attraction will be to a male body. The ancients have always known as expressed by a thousand variety of fertility symbols, that the moon forces control sex and generation.

This entire process has always been likened to the descent of spirit (from the zodiac or heaven) into matter (the moon and earth) and the corresponding ascent of matter into spirit. (See diagram on Page 70.) The soul made of pure and celestial substance descends into the various degrees of matter ending in an earth manifestation as mineral, plant, animal or man. Thereafter, the soul ascends to the primitive condition in the heavens after purging and cleansing itself by travel through the planetary worlds from the effects of its contact with the earth elements of fire, air, water and earth.

3. Chaldean Calander

The other drawing in THE CHALDEAN CALENDER , shows the Ancient Chaldean order of the planets in the zodiacal houses in relation to the ancient platonic elements of fire, air, water and earth.

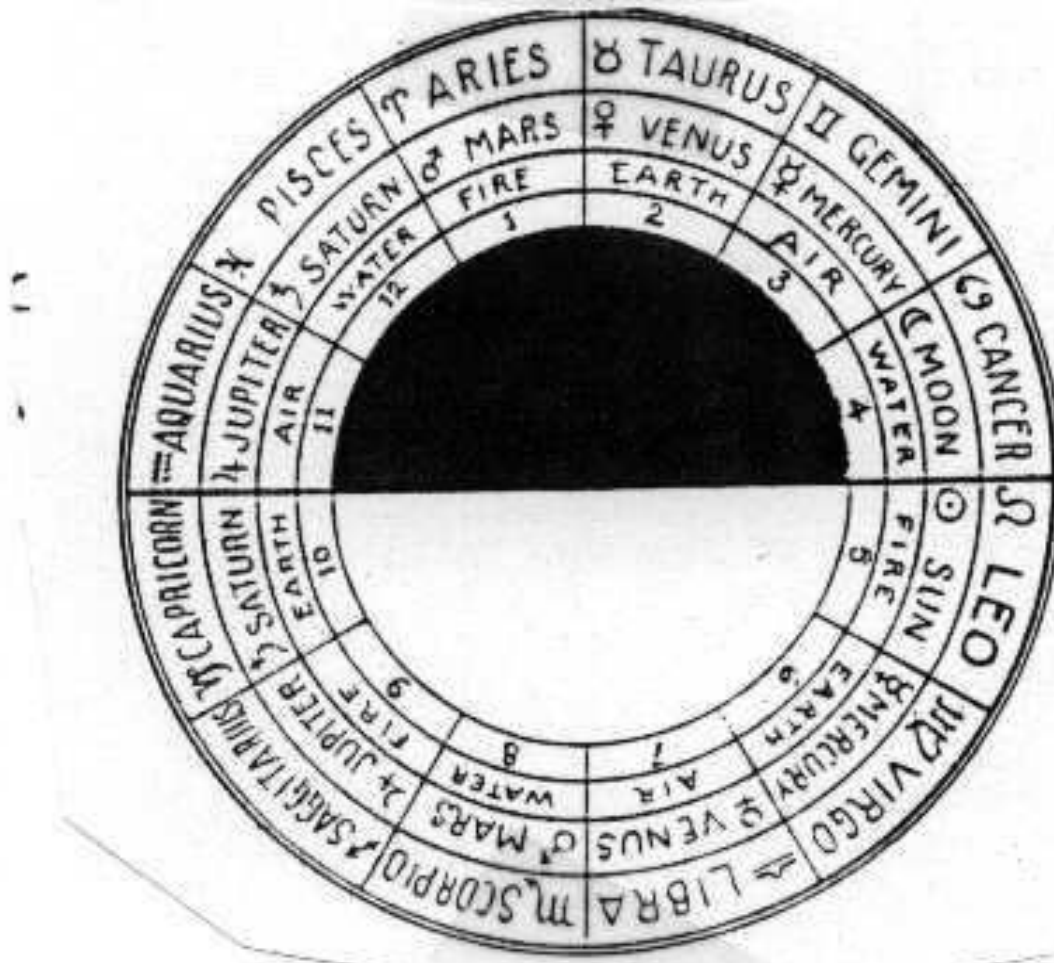

From this table can be derived first, the order of the days of the week, based upon the occult principle that the first hour of the day is influenced by its planetary namesake. Thus,

- Saturn = Saturday
- Jupiter = Thursday
- Mars = Tuesday
- Sun = Sunday
- Venus = Friday
- Mercury = Wednesday
- Moon = Monday

Beginning with Saturn on Saturday, the first hour is governed by Saturn, and the remaining hours are governed by each successive planet for one hour. Thus, $3 \times 7 = 21$ hours and in a twenty-four hour day, this divides out with three extra hours. Saturn would rule the 1st, 8th, 15th and 22nd hour, respectively. Then counting three hours extra as, $23 =$ Jupiter, $24 =$ Mars, the first hour of the next day would be the 25th hour or Sunday! Likewise, the 25th hour of the next consecutive planetary day would be (+3) the moon or Monday. The order and names as the days of the week are consistent throughout all cultures.

Secondly, from the Chaldean calendar can be derived the weeks of the year. An ancient tradition was preserved by Epiphanius (the Fourth Century Christian polemic historian) when he described the birthday of Christ as follows. "The Savior was born in the forty-second year of Augustus, King of Rome...and on the 6th day of January after thirteen days of winter solstice and the increase of light and day...For it needs must have been that this should be a figure of our Lord, Jesus Christ Himself, and of his twelve disciples, who made up the number of the thirteen days of the increase of the light."

Epiphanius would count the first year of Augustus (Octavian) from the date of the death of Julius Caesar at 44 B.C. and thereby placing the birthdate of Christ in the year of 2 B.C. This birth date is in close accord with the Canonical date of Christ, which custom began with Dionysius Exiguus.

So why would this very orthodox Roman Canonical historian set Christmas on January 6th instead of December 25th, the traditional exoteric date? The reason was that he was attempting to preserve an ancient esoteric tradition that was lost with the Reformation of the Roman calendar!

That the ancient Jews knew the precise length of the solar year is demonstrated by the genera of the word Oriens (meaning spiritual east) as $O = 6$, $R = 100$, $I = 10$, $E = 5$, $N = 50$, and $S = 200$ equals 371 or 365 (days) plus 6 (hours). Now, approximately 47 B.C. a Babylonian Jew named Sosigenes sold this secret of the length of the solar year to Julius Caesar. At that time the exoteric calendar was so far deteriorated that January 1st would have fallen on October 13th. Caesar reformed the calendar to conform it with the seasons again by inserting two extra months, one of 33 days and one of 34 days between November and December of that year and adding a 23 day month to the preceding February. The extra 90 days would fix the next calendar year to 365 days and a leap year every fourth year. This arrangement has lasted to modern times, and is known as the Julian Calendar.

The problem came when trying to set the beginning of the solar Julian year after abolishing the old Lunar year of the Romans. The ancient esoteric sources would have begun the new year on either of the seasonal solstices or equinoxes that coincided with a new moon. For example, if Caesar desired to start the new year at the time of the winter solstice, then he would have waited until a new moon occurred on December 21st or 22nd and called that day the "Calends of January". However, either he did not know the esoteric wisdom or he couldn't wait. In that year, the solstice fell on December 24th and the new moon was seven days later. The full month of December at that time had thirty days so the calends of January was set seven days after December 24th or January 1st as we now know it. Thus, the new year begins on January 1st and not on the day of the winter solstice. In retrospect, Caesar got less than what he paid for, only some of the ancient wisdom, not all of it!

After the birth of Christ, early Christians wanted to preserve a tradition reflecting the true birthday of Christ in relation to the true esoteric calendar year. The ancient wisdom taught that a secret astronomical cycle begins with the first full moon or 14 days after the new moon falls coincident with a winter solstice. Since, in the first Julian year, winter solstice fell on December 24th and after the month was extended from 30 to 31 days, the full moon would have occurred on January 6th (actually 13 days in this particular cycle). For this reason Epiphanius and the early Christians set the esoteric birth date of Christ on January 6th, and celebrated what has come to be called the Feast of Epiphany.

The Chaldean calendar shows a third astronomical relationship, this one in relation to our "great Platonic Year" cycle of 25,920 years. (See page 58-59.) Each year as the sun passes on its yearly cycle of 365 days through each zodiacal house, it returns to its starting point, the vernal or spring equinox. As previously discussed, this point precesses one degree every seventy-two years and through one sign of the zodiac every 2,160 years. This is our familiar Messianic cycle. Thus, the vernal equinox stands in one zodiacal house for a period of 2,160 years.

The ancients called these periods an "age" of the zodiac and also called these periods a "religious age" because each age was accompanied by a particular Messiah. (See pages 53-54, for the ages of the Rishis, Zoroaster, Hermes, Christ, etc.) Hence, each religious age was derived from its zodiacal sign such as the Taurean Age, Piscean Age, Aryan Age, etc. Because of this relationship, the symbols of all religions have an astronomical basis, the key to which is the zodiacal house. For example, during the Taurean Age, the bull was sacred as depicted by the Egyptians as Apis, and the Persians as Mithras and to Aaron and the Jews in the desert as the golden calf. In the Piscean Age, the fish was the symbol of deity as described by St. Augustine, if you join the first letters of the Greek words for "Jesus Christ, Son of God, Savior" they will form the word FISH, which the Fisher of Men fed the multitudes on Mount . There is no need to elaborate on the astronomical basis for religious symbolism here, but it is worthy to respect the incredible effort made by the 19th Century occult writers such as Godfrey Higgins in *Anacalypsis*, Albert Pike in *Morals and Dogma* and the Madame H.P.B. in *Isis Unveiled*. They removed the veil of hypocrisy from the so-called mysteries of the Church and showed the true pagan mystery cult sources of all great religions.

The religious zodiacal ages are explained in as many different ways as there are different cultures. However, the Chaldean calendar is uniformly the astronomical source of all occult astrology. As only one example here is the Rosicrucian system.

In his lecture series entitled, Ancient Myths, R. Steiner described the relationship between the Chaldean calendar and the cultural epochs for the Post-Atlantean or Fifth (Aryan) root race as follows:

1. For the Ancient Indian or first sub-root race, the vernal (spring) equinox of the sun was in Cancer, and the corresponding planet was the moon. The three decants (not shown in the calendar) were Venus, Mercury and Moon.
2. For the Ancient Persian or second sub-root race, the vernal equinox was in Gemini and the corresponding planet was Mercury. The three decants were Jupiter, Mars and Sun.
3. For the Ancient Egyptian-Chaldean or third sub-race, the vernal equinox was in Taurus and the corresponding planet was Venus. The three decants were Mercury, Moon and Saturn.
4. For the Ancient Greek-Roman or fourth sub-race, the vernal equinox was in Aries and the corresponding planet was Mars. The three decants were Mars, Sun and Venus.
5. For the fifth and present sub-race, the vernal equinox is in Pisces and the corresponding planet is Jupiter. (sic, Saturn?) The three decants are Saturn, Jupiter and Mars.

Following the Chaldean calendar, the next cultural epoch or sub-race will stand in the house of Aquarius. As to the different characteristics the forces of the zodiacal houses, planetary houses and decants effect on cultural evolution, the subject is very confused and left to the speculations of astrology.

Finally, an interesting and maybe the most revealing correspondence of religious astronomical symbolism is found in the four Cardinal signs of the zodiac. Back in Chapter 1, page 19, reference is made to the twelve fold nature of the zodiac as a result of the efforts of the Cherubim. This effort was expressed through the four fixed signs or Cardinal signs as Taurus (Bull); Leo (Lion); Scorpio (Eagle); and Aquarius (Water-Man). The ancient wisdom of all cultures recognized their significance, from the vision of Ezekiel in the Old Testament to the Revelation of St. John in the New Testament. Because of their universal cultural significance, it is fair to conclude that the four cardinal signs of the zodiac hid the secret name of God, which name was known by all ancient cultures, not only the Jews. Taking the numbers from the Chaldean calendar for these four signs we have, 2 (Taurus) + 5 + 8 + 11 equals 26, the number of Jehovah!

4. The Twelve Degrees of Freedom

The ancient wisdom teaches that there are six primary forces in nature which in their unity is represented by the seventh or the Astral Light. The Quabbalists and Hermetic philosophers called the Astral Light the heavenly or celestial virgin. T. Subba Row in his article, The Twelve Signs of the Zodiac, states that in the Brahman Esotericism, the sixth sign of the zodiac, Virgo represented the virgin and the six primary forces in nature which he terms: (1) Parasakti; (2) Jnanasakti; (3) Icchasakti; (4) Kriyasakti; (5) Kundalinisakti; and (6) Matrkasakti.

Our 20th Century spokesman for the geometry of the ancient wisdom is R. Buckminster Fuller. He also recognizes the occult law of the six primary forces in nature which he translates into six vectors of freedom as represented in the six edges of the tetrahedron. In Synergetics 2 he states,

"There are six basic motions in Universe. All of them are positive and negative; active and passive. The first five are individually experienceable and popularly familiar; the last - precession - is less popularly familiar:

-Spin: Spinning is horizontal or vertical axial rotation. Spinnability has to be totally independent of the system's local surface transformation.

-Orbit: No path of travel may be 180-degree linear in a multibodied, gravity-cohered, omnimotional Universe. The initial reality of all travel is orbital as a composite resultant of all tensive restraints. As the Sun's pull on the Earth produces orbiting, orbiting electrons produce directional field pulls. As 99.99 percent of the bodies in motion in physical Universe are operating orbitally, orbiting must be thought of as normal. (Spinning and orbiting together is dancing.) Orbits are regenerative feedback circuits.

-Inside-out: Anything with a hole in it turns inside-out. The tetrahedron turns inside-out through any of its four space-windows faces. Kissing humans turn partially inside-out as they "pucker" their lips.

-Expansion-contraction: Expansion is radiant divergence, and contraction is gravitational convergence.

-Torque: Torque and counter torque are local twists in which one pole spins right and the other pole spins left.

-Precession: Precession is the effect of bodies in motion on other bodies in motion in interrelationship patterns of other than 180 degrees. Reactions and resultants are precessional, bringing about orbits and not straight lines. For instance, the effect of the Sun traveling around our galaxy center at 700,000 miles per hour upon the Earth cotraveling with the Sun; the precessional effect of gravity between the two is an effect at 90 degrees to the Sun pull, which makes the Earth both spin and orbit around the Sun."

Now these six basic motions as positive total six and as negative total six more, for a total of twelve motions or vectors of restraint. R.B.F. invented the term "twelve degrees of freedom" to describe these twelve exercises of the six motions. Together, they produce structure because they hold a thing or system together into one integral unit.

There is no gray area here. If there is one less vector of restraint, the thing will change its shape.

These six systemic interrestraints (manifest in duality, forwards and backwards direction) produce structure and the minimum structure is the tetrahedron. Once we have this minimum system, then we have a thing that can rotate, orbit, torque, etc.

Now, any unity once produced is in itself a potential nucleus. But we now know that to become a prime nucleus, the system needs twelve similar units closed packed in equal distance from the center. This arrangement, as we saw on page in relation to the zodiac and central sun, locks the prime nucleus inside.

5. THE ANCIENT ELEMENTS

The ancient wisdom teaches that the four elements represent conditions or states of matter. Earth meant everything in a solid state. Water meant everything in a fluid state. Air meant everything in a gaseous state. These conditions are recognized by modern science. Fire, however, is not recognized by modern science as a condition of matter. In any chemistry textbook, the equations of chemical transformations never include the element of heat or fire. Fire is only relative degrees of atomic motion.

The essential quality of fire is ubiquitous. It permeates earth and warms it. It permeates water and air and warms it. It is the actual cause of the chemical transformation from solid to liquid to gas and back again. It is the background or ether for molecular change in the same way light is the ether for making objects visible.

Fire is a trinity of flame, light and smoke and a bridge between the physical and spiritual (meta-physical) worlds. From the burning flame, light and smoke is produced. The light ascends to the spiritual world. The smoke descends to the material world.

The ancient wisdom teaches that smoke creates the material, physical world. In the opaque turbidity of smoke reside elemental spirits or beings. Smoke is already in the chemical state of air or gas, thus the act of flame creates the first state of matter. Air is condensed or densified warmth from the original condition of the flame. As the air condenses, it becomes a liquid and as the liquid condenses, it becomes solid matter. In this way there is an evolution of the states of matter from smoke to air, to gas to solid matter. This also tells us something about the consecutive order of evolution. Air existed before liquid and liquid existed before earth. This order, long recognized as an elementary occult exercise, is obvious in our planetary system. The sun is fire, the atmosphere is air, the oceans are water and the continents are solid matter.

The key to the evolution of the states of matter is the smoke in which elemental beings of fire or salamanders are trapped. This process is the foundation for the occult law of the descent of spirit into matter and the ascent of matter into spirit, in seven stages. At each stage of densification, an elemental being is trapped. In the element of air is trapped the elementals called sylphs. In the element of water is trapped the elementals called undines and in the element of earth is trapped the elementals called gnomes. The higher spiritual hierarchies send down these elementals that live in fire and through the transformation of smoke, trap them in air, water and earth, thereby creating our three states of matter on the descending curve.

On the ascending curve of matter into spirit, the opposite occurs. As earth is transformed by fire into the liquid state, the trapped elementals are released. Likewise, as water is transformed by fire into air, elementals are released. The elementals that are trapped on the descending curve are released on the ascending curve. The transformation of day and night by elementals is a microcosmic event corresponding to this macrocosmic event.

The original teaching of elementals come from the Holy Rishis of ancient India and is preserved in the sacred texts of the Vedas and Bhagavad-Gita. For the Hindus, the king of the gnomes is called Kshiti; the king of the Undines is Varuna; the king of the sylphs is Vayu and the king of fire is Agni.

In the ancient Persian epoch, these teachings were recorded in the sacred text of the Zend-Avesta and preserved in the cult of Mithras, esoterically the constellation of Taurus. The founder of this cultural epoch, Zarathustra, is commonly referred to as the fire magician. Zarathustra is said to have been the son of Vesta, (the wife of Noah) and Oromasis, the king of the fire salamanders. For this reason an eternal flame is kept burning in the temples of the Magi.

In the ancient Chaldean epoch, the four elements are grouped in triads through the zodiac. To fire belongs, Aries, Leo and Sagittarius; to air belongs Gemini, Libra and Aquarius; to water belongs Cancer, Scorpio and Pisces; to earth belongs Taurus, Virgo and Capricorn.

In the Chaldean-Hebrew Quabbalah preserved as ceremonial magic to this day, we find the names of the four elements and their dominions.

	Ruler	King	Angel	Direction
FIRE	Djin	Seraph	Aral	South
AIR	Ariel	Paralda	Chassan	East
WATER	Tharsis	Nichasa	Taliahad	West

EARTH	Kerub	Ghob	Phorlakh	North
-------	-------	------	----------	-------

Each element also has its ruling archangel and sephiroth in the Tree of Life. In addition, each element works through the four fixed signs of the zodiac: air-man-Aquarius; fire-lion-Leo; water-eagle-Scorpio and earth-bull-Taurus. Ultimately, knowledge of the elementaries living in the four elements led to selfish ceremonial magic and Theurgy was personified in Iamblichus. He writes, "the gods, the angels and the daimons as well as the souls, may be summoned through evocation and prayer. But when, during the theurgic operations, a mistake is made, beware! Do not imagine that you are communicating with beneficent divinities, who have answered your earnest prayer, no, for they are bad daimons, only under the guise of good ones! For the elementaries often clothe themselves with the similitude of the good, and assume a rank very much superior to that they really occupy. Their boasting betrays them."

Obviously, theurgy, is the denigration of the ancient mystery knowledge similar to what Steiner calls the betrayal of the Vulcan mysteries in Atlantean times. Fortunately, at the beginning of the Greek-Roman fourth cultural epoch, Plato clothed the ancient mystery knowledge in symbols of rational thought. At the age of fourth-nine, Plato was initiated on the alter of the Bembine tablet of Isis in the great pyramid of Cheops. After death on the wooden tao cross, three days buried in the granite sarcophagus, he was raised to the glory of Osiris in the rising sun. Is it strange he would say that fire is a pyramid?

THE TIMAEUS

Plato records the ancient wisdom in his TIMAEUS. First, he recognizes the serial order of the descent of spirit into matter. "Let us now therefore distribute the four sorts of things which we have generated into fire, earth, water and air... To fire, the most easily movable form; the second according to the generation to air; that which is third to water...and the most immovable to earth."

Second, he recognized that great occult law of densification, "nature abhors a vacuum". The descending curve is contraction, the ascending curve is expansion. The tendency towards condensation thrusts smaller particles into the interstices of the larger, the lesser divide the greater and the greater unite the lesser. Changes in size cause changes in space and this inequality affords a perpetual motion, both at the present and at all time in the future.

"The circulation then of the universe, since it comprehends the different sorts of things in its circumference, being of a circular form, and naturally desiring to pass into union with itself, compresses all things within its spacious receptacle, and does not suffer a void place anywhere to subsist. On this account, fire in the most eminent degree penetrates through all things."

Third, he recognized the proportional structure of matter, fire to air, as air is to water as water is to earth. For example, "two bodies of fire coalesce into one form of air". Or, "when air becomes vanquished and separated into parts, then from two wholes and a half one form of water is produced". Represented geometrically, one air particle is equal to twenty equilateral triangles. This may separate into two particles of air (eight equilateral triangles each) and one particle of fire (four equilateral triangles); thus $20 = 8 + 8 + 4$ equilateral triangles. The constancy of these proportions corresponds to the fixed proportion by weight discovered by John Dalton as the basis of modern chemistry.

Lastly, he recognized the corpuscular structure of matter. To each of the elements he assigned a geometrical shape, the common denominator of each being a scalene triangle. To the element of fire he designated "the solid form of the pyramid is the element and seed of fire". For Plato, the four states of matter are regular stereometrical forms, inherently divisible as are our modern atoms of Bohr and Rutherford. As the polyhedra are split, their equilateral and scalene triangles disperse into spirit, energy and potentiality. As the triangles re-combine, the form of matter returns to actuality in regular, fixed patterns.

Alfred North Whitehead remarked, "the Timaeus of Plato and the Scholium of Newton are the two statements of cosmological theory which have had the chief influence on Western thought. The Timaeus...conveys profound truth...Newton would have been surprised at the modern quantum theory and at the dissolution of quanta into vibrations; Plato would have expected it."

GEOMETRY That R. Buckminster Fuller would recognize the pyramid or tetrahedron as the corpuscle of fire goes without saying. In SYNERGETICS I he discusses the chemical bonding of the tetrahedron and the states of matter as follows.

The single bonded tetrahedra system is similar to a pin joint. All tetrahedra are joined to each other by only one vertex and as a result, each corpuscle can rotate in any direction around the single vertex. This corresponds to the compressible and loan distributing behavior of gases.

The double bond tetrahedra system is like a hinge joint. Two vertexes of each tetrahedra are joined along a single axis, an edge length. Each corpuscle can rotate perpendicularly about an axis. This demonstrates the load distributing but non-compressible behavior of liquids.

The triple bond tetrahedra system is similar to a fixed joint. It occurs when three vertexes of each tetrahedra come together on a face. This close packing, triple-bonded, fixed end arrangement corresponds to the formational and continuing behavior of crystalline molecular compounds, or solid earth.

In addition, there is a fourth bond that gives the solid-earth element two classes, the first being the crystalline class and the second being the diamond-metal class. The four or quadruple bond occurs when all four vertexes of the tetrahedra are congruent. This is maximum densification of the descending arc and occurs for example, when soft triple-bonded carbon converts into the hard closest-packing quadrivalence of diamond.

In metals we also see this quadrivalence, but not in the vertexes, but in congruent centers of gravity. X-ray diffraction studies by Linus Pauling showed all metals to be tetrahedrally close packed interlinking the gravitational centers of the compounded atoms. The bonds are formed mid-edge and mid-face and demonstrate the superior strength and hardness of metals.

In conclusion, we see the geometrical array of the primary elements in tetrahedral bonding arrangements as follows:

FIRE	tetrahedron		
AIR	single bond	pin joint	vertex
WATER	double bond	hinge joint	edge
EARTH	triple bond	crystalline	face
	quadri-bond	metals	congruent face

See tetrahedral bonding chart

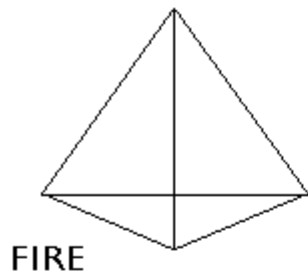

FIRE

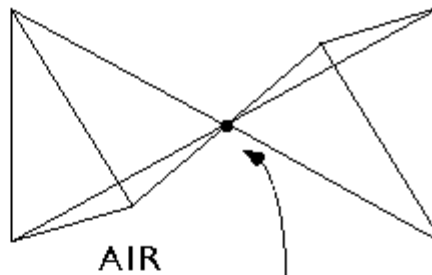

AIR

Single-Bond Vertex

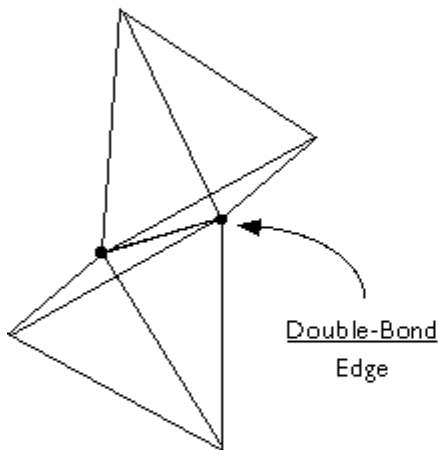

WATER

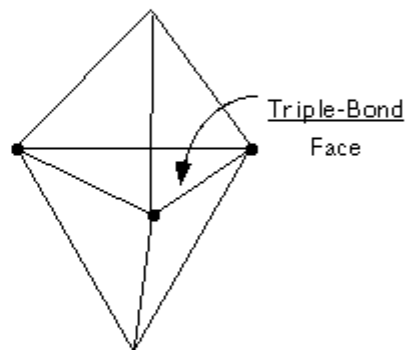

EARTH (*Crystal*)

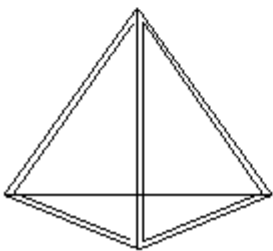

EARTH (*Diamond*)

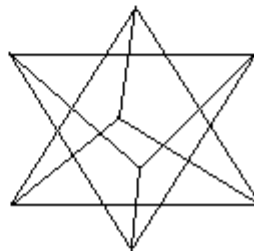

EARTH (*Metals*)

YOU ARE WHAT YOU EAT.

The spirits that live in the ancient elements are bound to a sub-physical earth evolution. The physical earth evolution in this Fourth globe of this fourth round is monadic progression from mineral, plant, animal and man. In the supra-physical or astral evolution is spiritual progression continuing from the three previous planetary evolutions of Old Saturn, Old Sun and Old Moon, through the angels, archangels and archai, etc. On the chain of life below the physical earth evolution and the spiritual astral evolution lie the three elementary conditions.

Steiner says that the three elementary conditions are formed from the detached astral substance of the group souls of animals. Each animal species is nourished by a group soul existing on the astral plane. When an individual animal dies, the group soul or group ego remains alive, and replenishes the species with a new individual member, similar to losing a hair and then a new hair grows in its place. When an animal species becomes extinct, there is no death. Death only occurs for humans between the Lemurian and sixth epoch. The extinct group soul metamorphoses into a higher spiritual being, such as when an archangel ascends into archai.

A situation does occur when a whole series of animals draw too much out of the group soul. In the normal situation, the part that remains over becomes detached from the group soul and leads as separate isolated life as an elementary. Thus, from animals who live in the air, arise sylphs. From animals who live in the water, arise undines and from animals who live on earth, arise gnomes. In a particular situation where the animals have carried their development (such as the ape) too far, have developed an ego or fourth principle similar to that of a human, they cannot return to the group soul and live an elemental existence as salamanders.

These elementary beings actually enter the human physical body and help repair and maintain it. In the food we eat and the air we breathe, enter the elementals which transform foodstuffs through digestion into the three bodily humors of chyle (intestinal fluid), lymph and blood. In a very direct sense, these three body humors impregnated with elementals control the human organism. The glandular system is an expression of the etheric body, the nervous system is an expression of the astral body and the ego finds its expression in the blood. Likewise, the circulation of the intestinal food fluids are connected to the etheric body, the lymph fluid is connected to the astral body and the blue carbon rich blood is transformed into red blood by fire elementals when combined with oxygen in the lungs.

This intimate relationship between our physical, etheric, astral and ego bodies being sustained and nourished by the elementals arriving in our food stuffs has both a positive and negative aspect. It is good in the sense that a nervous system cannot function without astral beings active in it nor can a blood system circulate without ego-beings also active in it. At night, these beings cooperate to restore, rebuild and replenish the strength of our various bodies that has been spent during the day.

However, to the extent that the ego does NOT control the life processes, the elementals control the life processes for us. Human evolution is the development of the higher trinity of Manas, Buddhi and Atma, and this occurs as the ego gains control and mastery over the lower quaternary of physical body, etheric body and astral body. That portion of the astral body transformed by the ego is called Manas, that portion of the etheric body transformed by the ego is called Buddhi and that portion of the physical body transformed by the ego is called Atma. The portion of the lower quaternary under the control of the ego is forever ours, increasing through each incarnation. However, that portion that is untransformed is forever theirs, and in this sense the elementals actually control life processes of our lower quaternary.

THE LAMB IN ARIES.

We know that these elemental beings enter into man during his entire life and remain there imprisoned. The issue is whether or not they can be released at death.

In SPIRITUAL HIERARCHIES, Steiner says, "When a person goes through the gate of death, there is a distinction between these elemental beings who merely entered into him and have not been led back to the higher elements, and those who, through man's activity, have been guided back to their former condition. Those who have not been transformed have gained nothing by wandering from the outer world into man; others are able to return to their former condition after man's death. During life on earth man builds a cross-road for elementals. When man has gone through life in the spiritual worlds and returns in a subsequent incarnation through the gate of birth, all elemental beings whom he did not release, accompany him into physical existence. Those whom he releases do not accompany him any longer; they return to their original condition."

These interplay of the elementals during earth evolution takes place in the four cosmic arenas of man, earth, moon and sun. In the sphere of man, there is the bewitchment of Lucifer and Ahriman (discussed supra). In the sphere of the earth, elementals live in the processes that transform day and night. A person who is "creative, active, diligent and productive" contributes to day time elementals in their ascending phase. However, a person who is lazy and unproductive does not transform those elementals of the night into productive forces of the day light.

Similarly, there are good and bad elementals that dwell in the waxing and waning of the moon sphere. A person's mood, whether content and cheerful or angry and depressed, determines the release or entrapment of these spirits.

Lastly, there are the elements that live in and transform the summer and winter seasons within the sun sphere over the course of the year. Certain elementals become trapped during the winter and only through human devotion and spiritual understanding, are they released at death.

Thus, in addition to the elementals that become trapped inside man arising from the consumption of foodstuffs, there also are elementals that become trapped inside man arising from the planetary evolution of earth, moon and sun. It is important to distinguish the twofold effect upon personal and planetary evolution.

First, as concerns personal evolution, each individual human carries the karma of these elementals within themselves. Those elementals that are transformed and released are themselves guided to a higher stage of being and can participate in planetary evolution in the earth, moon and sun spheres. However, those that remain trapped are released at death but return to ourselves during the next incarnation.

Second, as concerns planetary evolution, humanity is that fulcrum through which the elementals of nature must pass on the ascending curve of matter into spirit. The Law of Seven teaches that at every level in the spiritual hierarchies, from the Seraphim down to the elementals, there are ascending and descending forces. In the earth sphere there are the ascending forces of daylight and descending forces of nighttime. In the moon sphere, there are ascending forces in the waxing of the moon and descending forces in the waning of the moon. In the sun sphere, there are ascending forces in the summer season and descending forces in the winter season. For each sphere of planetary evolution, there are elementals trapped in the descending forces that need to be liberated and released into the ascending forces. In each sphere, mankind is the crucible in which this transformation either occurs or does not occur.

Ultimately, the heavenly ladder of these lines of forces converge upon the zodiac. This is the cosmic secret expressed in Ezekiel's wheel, first made exoteric by Hargrave Jennings in the ROSICRUCIANS and later by, Madame H.P. Blavatsky in ISIS UNVEILED.

However, it was Steiner in his lecture series entitled, THE INFLUENCE OF SPIRITUAL BEING UPON MAN, (1908) who explains the mystery.

Descending forces come from the five constellations of Scorpio, Sagittarius, Capricorn, Aquarius and Pisces. Ascending forces come through Aries, Taurus, Gemini, Cancer, Leo, Virgo and Libra. "The forces which are in the descending phase of evolution have first to pass through man and within him to attain the stage at which they too can become ascending forces."

The purpose of this earth evolution is to develop the fourth principle or ego. To the extent that mankind transforms the descending forces through his ego into ascending forces, the group ego of humanity participates in planetary evolution through the Jupiter, Venus and Vulcan Manvantaras. If mankind accomplishes its task, during the Vulcan Manvantara, our earth will evolve into a sun and our sun will evolve into a member of the Zodiac, with Christ as our leader.

Christ as a Spirit of Wisdom is a seven principled being, whose lowest member extends down to Libra and whose highest member extends upwards to Aries. In the Table of forces (supra) the lowest member for man is in Pisces and his highest member, Atma, extends upwards to Virgo. It is through the ego that the higher principles develop, so as man evolves up towards Atma in Libra, so does the Christ Being look with his microcosmic ego upwards to the constellation of Aries. Hence, the occult designation of the Mystical Lamb. As described in THE GOSPEL OF ST. LUKE, Christ is the center of the lodge of twelve Budhisattvas directing earth evolution. This is an earthly PREFIGURATION of the cosmic arrangement of Christ being spread into the Zodiac.

As can be seen in the drawing from an early Christian mosaic, Christ is also referred to as the sacrificial lamb, seen here with a sword penetrating the body of a lamb (esoterically Aries).

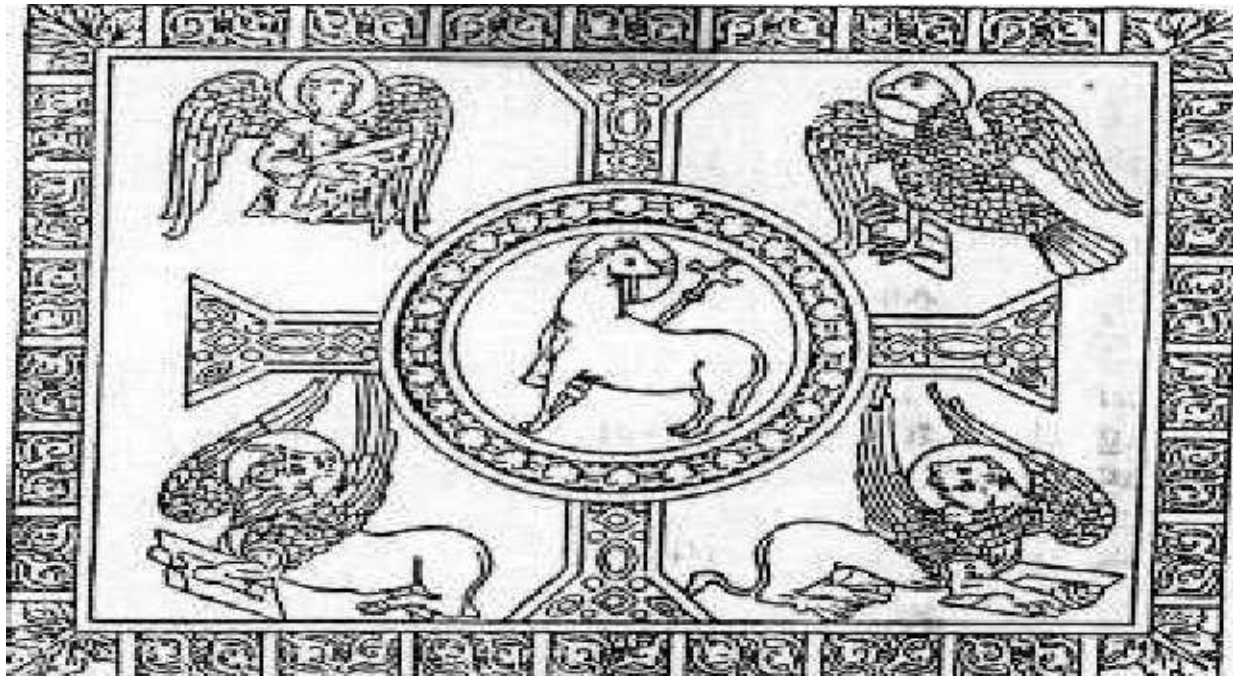

The sacrifice of Christ is that he held back or remained behind in his own macrocosmic evolution twice, once during the Old Sun Manvantara and again during the Old Moon Manvantara. Christ developed his ego or fourth principle outside earth evolution and for this reason He was not directly connected with earth evolution, as are the Spirits of Form of the sun who are directly connected with earth evolution. Christ sacrificed his macrocosmic ego so that mankind could develop its microcosmic ego during the earth evolution. Because He remained behind, the greater sacrifice was that He did not take the opportunity to develop his fifth, sixth and seventh principles. Because He united with earth evolution, mankind will evolve with Him during the Jupiter, Venus and Vulcan Manvantaras.

THE LAMB IN THE SECOND SEAL

In our early Christian mosaic, we see the lamb in the center surrounded by the four beasts of the Apocalypse. Being an archetypal symbol, it relates on many levels, from correspondances with the ancient four elements to the cardinal signs of the zodiac. What is this symbolism of the sacrificial lamb as the second seal used by St. John?

Dr Steiner in his *APOCALYPSE OF ST. JOHN* (1908) explains that mankind did not always have a individual soul. During the first four sub-races of the fourth Atlantean root race, mankind shared a common group soul, similar to the way plants and animals share a common group soul for each species. Technically, these group souls are offspring of the second angelic hierarchy. These group souls are in fact a common group EGO (as fifth microcosmic principle) that live on the astral plane.

In the kingdoms of nature, for minerals, plants and animals, the group ego has not descended into the physical plane. For mankind, the descent of the macrocosmic ego occurred during the fifth sub-race during the epoch of Libra, the scales. As shown on the previous plate of Ezekiel's Wheel (esoteric), Libra is the midpoint of the ascending and descending forces of the zodiac. Prior to this time, up thru Virgo, the forces were not balanced, the descending forces outweighing the ascending forces. With the entry of the cosmic ego into individual men during the Libra epoch, the ego can henceforth participate in the forces of the zodiac. Now, the scales have tipped and there are seven ascending forces and only five descending forces. This is the exact meaning of what was said earlier about the descending forces in evolution must first pass thru mankind.

Prior to the descent of the cosmic ego into the microcosmic individual ego, there had to be an evolutionary development in successive stages on the physical plane. Each of the four beasts represent a sub-race of Atlanteans:

- | | |
|------------------|------------|
| 1. Tmoahl race | bull cult |
| 2. Tlvatli race | lion cult |
| 3. Toltec race | eagle cult |
| 4. Turanian race | man cult |

The BULL represents the perfect animal of digestion as reflected in the abdomen of the human. He converts earthly forces into spiritual forces and when he dies, his forces return to the earth, to renew the earth.

The LION represents the perfect animal of the breast as reflected in the thorax of the human. Here there is an equilibrium between breathing and blood circulation. Digestion is relatively quick, giving a balance between breathing and the heartbeat. Notice the smile on the lion or cat after dinner.

The EAGLE represents the perfect animal of the head as reflected in the head of man. It lives so much on breathing, that the other processes of digestion and circulation are almost non-existent.

All these beasts take earth forces and transform them into spiritual forces. The animals represent the three fold human organism of head-chest-abdomen. Together, in unity, they represent the fourth beast, the perfect man. In man, the cow-bull is the earth animal and evolutionary perfection of digestion in the abdomen. It belongs to the sphere of moon-mercury-venus.

The lion is the evolutionary perfection of breathing and circulation and is represented in the sun sphere. The eagle is the evolutionary perfection of head forces and is represented in the sphere of mars-jupiter-saturn. Thus, the three fold human organism is represented in the three beasts and in the three planetary spheres. Also, these three spheres are represented in humanity as a whole, with the East and Orient as the cow-bull; Central Europe as the lion and Western Europe and America as the eagle.

Now, each of these four beasts has a corresponding group soul that guided these four evolutionary stages. In the APOCALYPSE of St. John, each beast was a symbol of each group soul. In the fifth sub-race, during the time of the sun's precessional cycle in Libra, the seed of the individual ego was laid and these typical etheric forms disappeared.

The lamb in our mosiac is a symbol of the fifth group soul which will exist throughout the entire manvantara. As a whole, it represents the higher trinity in man of Manas-Buddhi-Atma. In our old Pythagorean symbolism of the lower quaternary, as a square of the lower four principles: physical, etheric, astral and ego; the lamb represents the higher triangle. This is an eternal symbol because it represents the higher triangle as MACROCOSMIC PRINCIPLES. The cosmic ego that descended during the Libra epoch was in fact the macrocosmic ego of the Christ being. HE too has only evolved his fourth principle, his ego, and the grand purpose of the Divine Plan of this earth manvantara is for humanity as a whole to evolve its fourth ego principle. Because of HIS sacrifice, Christ will share in our future evolution during the next three manvantaras.

During the Jupiter manvantara, on the fourth globe of the fourth round, He will again come to earth and give mankind his manas principle which HE is now evolving. Likewise, during the Venus manvantara, on the fourth globe of the fourth round, He will again come to earth to give us his Buddhi principle. Because Christ has united with earth evolution, as He evolves His fifth, sixth and seventh principles on a macrocosmic scale (our higher group souls) He will successively give these to all mankind as microcosmic principles, descending from the ether as the cosmic ego did during ancient Atlantis.

Granted, one might argue that certain people have evolved their higher principles to a certain degree, and this is good. Certainly, a genius has developed his manas and a saint his buddhi principles. However, this individual microcosmic development should not be confused with the Divine Plan of each manvantara. The development of these instances only occur through the assistance of Luciferic beings of an angelic nature, which because they did not complete the evolution of their higher principles during the last Old Moon manvantara, must now develop them personally thru us as individuals. So, we may have glimpses or even long years of these higher principles because the Lunas Pitris who temporarily live within us, but the higher qualities are not yet grounded in humanity as a whole, they are not yet born in us as the ego principle is already seeded into the fetus. This is a task for future manvantaras. The group soul of the Christ being, the active intelligence of Manas, will not descend upon humanity as a whole until the Jupiter manvantara, and when it does, it will be a further gift of the Christ, a gift of His being.

THE ATLANTEAN BEAST

Further symbolism in the APOCALYPSE of St. John is reflected in the beast with 7 heads. In the ancient mysteries, each typical animal form was represented as a HEAD. This is why Old Testament visions at the level of the first angelic hierarchy saw one beast with four heads. The vision of Ezekiel is such an example. When animal-man passed over to the human form in the fifth sub-race, he left behind the four animal head forms. In addition to the four animal heads, there are three more, reflecting the 5th, 6th and 7th sub-races of the Atlantean root race. Thus,

there were in fact seven heads in the fourth root race and this is why the beast in chapter 13 of the APOCALYPSE has seven heads. As a symbol of the fifth root race, the beast of seven heads represents the animal nature in mankind which must be evolved and passed over in the future.

The horns of the beast with seven heads represent, in the ancient mystery wisdom, the various organs in the physical human body. Each physical organ is a condensation from the corresponding etheric spiritual organ, known as chakras. What is called a horn is the organ in the physical body which evolved from the corresponding etheric chakra as an archetype. For example, the human heart reached its perfection during the second sub-race of the so-called lion cult and the heart is called the horn of the etheric lion head. So too for the bull and eagle.

At the end of the fourth sub-race of Atlantis, mankind had four heads and four horns. After the descent of the individual ego in the fifth sub-race, these horns evolved a male-female duality and nature and became double. Thus, at the end of the seventh sub-race, at the time of the Biblical flood, the etheric body of man was represented by seven heads and ten horns, one horn each for the first four sub-races (4) and two each for the next three epochs (6), which equals 10. For our seer of Patmos looking backwards in time over the evolution of the Atlantean root race, he saw a beast with seven heads and ten horns as described in chapter 13.,

Looking forward in time over the fifth root race, our seer of Patmos had a vision of evolution with the Christ principle within mankind. The symbol of this 'Christ within' is the lamb of the second seal. It is the end of the evolution of the fifth root race that St. John is describing in the APOCALYPSE as the Armageddon of humanity. For St. John, those people who have not evolved with the Christ principle within, past the animal nature expressed in the seven heads, will be cast aside in the abyss. They will retain the ancient Atlantis etheric form of the beast and will re-appear in the age of the pouring out of the vials of wrath, when the earth splits into two halves. The Christ men will appear, in the age of the seven seals (the sixth root race) in the white garments and the non-Christ men will appear as the beast with seven heads and ten horns.

TABLE OF FORCES

A final aspect of elementals that deserves consideration are those that have been trapped by the Luciferic and Ahrimanic influences.

From the direction of the moon towards earth and living in the earth's atmosphere are elementals manifested in the wind and weather. They are composed of the fire and air elements and have

no connection with the water and earth elements. These are the Luciferic spirits to which Steiner often refers.

From the direction of the center of the earth towards the planet surface are elementals manifested in the geological processes of plate tectonics including volcanoes, earthquakes, and so-called hot spots. They are composed of the earth and water elements and have no connection with the fire and air elements. Steiner refers to them as Ahrimanic beings.

Both of these classes of elementals work with more advanced and mature planetary beings. The Luciferic beings work with planetary forces instreaming from the moon, Venus and Mercury and work against the instreaming forces coming from Saturn, Jupiter and Mars. Likewise, the Ahrimanic forces work with the planetary forces instreaming from Saturn, Jupiter and Mars and work against the instreaming forces coming from moon, Mercury and Venus. It is the ordained task of the sun forces to keep these conflicting forces in check, for not to do so, leads to the Eighth Sphere.

The task of the elementals influenced by Altriman is to draw men down and fasten him forever to the earth. During life, they draw the instinctive nature out of man and at death, they try to chain the soul to earth. This effect can be seen in the shortened spiritual life, after death and before rebirth, while the soul travels through the spiritual hierarchies. By reducing the time the soul spends in a spiritual after life, the more this soul is drawn to earth and less likely to incarnate. The overall process is a sort of re-building of the group soul of humanity which has been reduced thru the development of the ego principle. The evolution of the ego through successive earth incarnations is necessarily a detachment from the group ego existing on the astral plane. Those two processes are inversely proportional and a war is waged in man over these competing forces. In those kingdoms that have a group soul, the mineral, plant and animal, there is no such conflict. Ultimately, Ahriman and his legions of sub-human earth- water elementals would desire to have mankind grounded to earth evolution and prevent the future Jupiter, Venus and

Vulcan Manuvantara's.

The task of the elementals influenced by Lucifer is in opposition to everything Ahrimanic. The Luciferic forces are connected to the higher bodies of man and desire to make him a spiritual and moral being, however, without freedom. This concept corresponds in me to a beehive or anthill in which there is a very highly sophisticated social and moral order, but without freedom. These elementals would like to see man evolve past his physical earth-water connection to the earth and live an angelic moral life in an astral condition, without a physical body.

In conclusion, we have the Luciferic spirits composed of fire and air competing for the higher triad. We have the Ahrimanic spirits composed of earth and water competing for the lower quaternary. Finally, we have man composed of all four ancient elements. When we add the houses of the zodiac from the Chaldean calendar that relate to the triads of the elements, we get a picture of man like this:

	PLANET	ELEMENT	HOUSE	CONSCIOUSNESS
Atma	Sun	fire	Leo	Virgo
Buddhi	Saturn	air	Aquarius	Libra
	Mars	fire	Aries	
Manas	Venus	air	Libra	Scorpio
	Jupiter	fire	Sagittarius	
EGO	Mercury	air	Gemini	Sagittarius
Astral body	Jupiter	water	Pisces	Capricorn
Ethereic body	Mercury	earth	Virgo	Aquarius
	Mars	water	Scorpio	
Physical body	Venus	earth	Taurus	Pisces
	Moon	water	Cancer	
	Saturn	earth	Capricorn	

Thus, as the ego transforms the astral body into Manas, we have the planets Jupiter and Mercury. As the ego transforms the etheric body into Buddhi, we have the planets Mars and Venus. As the ego transforms the physical body into Atma, we have the common planet Saturn and the union of the sun and moon. The lower quaternary is grounded in the earth and water elements while the higher triad is approached by the fire and air elements. Each principle is an expression of a duality in both the planetary level and the zodiacal level. At the zodiac level, the houses represent degrees of consciousness, of which there are twelve in all, with man reaching from Pisces up to Virgo, the highest level obtainable during this evolution of seven manvantaras.

AKAHSIA CHRONICLE

Prior to Eliphas Levi, no Western occultist was really open about his "source" of knowledge of the spiritual/occult history of mankind. Levi spoke of his source as the "Astral Light", which for him included the Akasha as well as all other phenomenon, including the "electro-magnetic ether, the ambient and all penetrating fluid, the vital light and the body of the holy ghost." As the good madame Blavatsky said "Eliphas Levi commits a great blunder in always identifying the Astral Light with what we call the Akasha." For her, "Akasha is not even the Ether, least of all then, we imagine, cannot be the astral Light, which is simply the older sidereal Light of Paracelsus." These are the reasons occultists refuse to give the name of the Astral Light to the Akasha or to call it the Ether. For the good Madame, "Akasha is space itself, in one sense, or both it's sixth and seventh principles", the fifth principle being is what is commonly called the Ether. And, " Akasha is the primary ether, emanating from Pradhana in seven forms of Prakrita, of which the Astral Light is the lowest", deriving from the forces of nature. As a cosmic element or bhuta, it is thru the Akasha that the light-sound and life ethers manifest as the 5th-6th and 7th principles of creation.

What is known in occultism as the Akasha Chronicle is the reflection of the Akasha in the three higher macrocosmic ethers of light, sound and life. For this reason, the Akasha Chronicle exists in the macrocosm on these three different levels and likewise can be "seen in vision" in the light ether, "heard" as sound in the sound ether or "swallowed" in

the life ether as in the "Book of Wisdom" related in the Apocalypse. Neither Levi nor the good Madame actually said that they read from the chronicle, but we certainly know that they did. It was Dr. Steiner in his two books, OCCULT SCIENCE and COSMIC MEMORY, who first said that he in fact read from the chronicle. Here he says, "The one who has the ability to perceive in the spiritual world comes to know past events in their eternal character...They appear before one in full life...Those initiated into the reading of such a living script can look back into a much more remote past than is represented by external history." From this script, Steiner has given us the historical facts of the Old Saturn, Old Sun, Old Moon and present Earth manvantaras, including the lives of the Lemurian and Atlantean racial Ages. Dr. Steiner did say that " I am obligated to remain silent about the sources of the information given here." Presumably, he had been restricted from revealing much of the "knowledge hidden within the Theosophical movement."

Long after the deaths of Levi, Blavatsky and Steiner, the Anon-ymous author of MEDITATIONS ON THE TAROT gives us a further explanation of the Akasha Chronicle and it's relation to the Fifth Gospel of Christ.

For Anon, "the Akasha chronicle is the macrocosmic analogy to the total memory of the microcosmic unconsciousness." For him, the unconsciousness corresponds to the collective psychic memory of all humankind as with Jung in his "collective unconsciousness." The three tableaux of psychic memory correspond to the three types of conscious memory which he terms the "Automatic memory, the Logical memory and the Moral memory." Automatic memory is that faculty manifested in childhood which reproduces in the imagination all the facts of the past as raw material for use by the conscious self. As such, automatic memory is "weakened in proportion to the extent with which age increases."

Logical memory is that faculty manifested during middle life , wherein the rational mind "weaves a tableau of the past according to the lines of sequential reasoning that intelligence finds relevant." The tableau of factual associations developed during childhood is replaced over age with a more meaningful memory of the relationships between things, events and ideas.

Moral memory is that faculty arising during old age wherein the memory tableau reveals moral and spiritual values. The recall memory of a person in old age depends on the intensity in which these values are interwoven with the past tableau of automatic and logical memories. What we observe as senility in old persons depends largely on the fact that those persons did not develop a moral memory tableau during their lifetime. Emotional intensity is the key here more so than the intrinsic moral value of an event. However, moral events always carry with it the requisite emotional intensity, such that all moral events are more likely to be remembered. For example, a senile person may not remember what he had for breakfast today, but he is likely to remember what he had for breakfast on the day of his first communion. this moral memory is a sort of common ground in which the other two memories take root.

Now this three fold human memory take it's correspondence in the macrocosm in the three-fold Akasha Chronicle, which in turn takes it's correspondence in the three-fold higher ethers of light-sound-life. Herr Dr. Steiner only spoke about a single cosmic memory which he describes as a sort of movie picture reel of pictures unfolding before the higher Imaginative consciousness. However, Madame Blavatsky recognized a two-fold cosmic memory as early as ISIS UNVEILED when she said, "The astral light is dual and bisexual, the male part of it is purely divine and spiritual; it is wisdom; while the female portion is tainted , in one sense, with matter and therefore is evil already." In the SECRET DOCTRINE the Madame says, "the seven principles of the Eastern initiates had not been explained when Isis Unveiled was written" and she goes on to say "they are one and the same thing seen from two different aspects, the spiritual and the psychic." She recognizes that the Akasha as a whole manifests in a septenary extending from the purely spiritual to the purely physical and as such, this creates two streams from the single source described by Steiner. Says Anon, "Thus, a two-fold process takes place in the Ahasha chronicle: it is spiritualized and at the same concretized, in proportion to the extent that the distance from the present into the past increases."

The trail of the chronicle extending backwards over long periods of time, on the one hand, ascends towards higher spheres and on the other hand, descends towards lower spheres, which for the good Madame was the duality of male/female, wisdom/tainted and spiritual/physical.

_____ Higher chronicle (2nd)

_____ (Back in historical time) _____ present time

_____ Lower chronicle (1st)

The lower Chronicle consists of the history of facts in a Quantitative tableau which corresponds in the microcosm to our automatic associative memory in humans. As such, it is subject to the errors and mistakes of interpretation and

extrapolation that also exist in automatic memory. In this regard Dr. Steiner said, "Spiritual perception is not infallible...This perception can err, can see in an inexact, oblique, wrong manner. No man is free from error in this field, no matter how high he stands." This "error of transcription" occurs because the further one goes back in history, the further the lower Chronicle has slipped from sphere to sphere, ending in what Blavatsky called the (subterranean) sphere of matter/evil. It is from this lower record that we see the clairvoyant investigations in the 20th century of C.W. Leadbeater and Edgar Cayce's visions of ancient Atlantean culture.

For this reason, both Anon and Steiner have stressed that there is no further need for new revelations from the Chronicle. (but what of the revelation of the two Jesus children?) What is necessary is to develop a "living tradition", where each occultist continues the work of his predecessor, by confirming the truth, filling in the gaps and correcting the errors of vision or interpretation. Steiner writes of a tradition,

"that various initiates can relate about history and pre-history will be in essential agreement. Such a history and pre-history does exist in all mystery schools. Here for millennia, the agreement has been so complete that the conformity existing among external historians of even a single century cannot be compared with it. The initiates describe essentially the same things at all times and in all places." .

The Second Akasha Chronicle is that higher, spiritual record which preserves a Qualitative tableau, which over time has separated out the distortions extant from the lower record. Just as our logical memory replaces the associative facts of our automatic memory, so too the higher Chronicle "is the intelligent memory of the history of the world." The abstractions used in our logical memory transform the associative facts of the lower Chronicle into symbolic facts in the higher Second Chronicle. These symbolic facts, thru this process of discrimination, must be extrapolated into universal intelligent forms , from which all occultists in their vision must draw conclusions to be placed in this "Book of Truth." The esoteric history of the world is drawn from these spiritual conclusions by such authors as Hildegard of Bingen, Fabre d'Olivet, Saint-Yves d'Alveydre, Rudolph Steiner and Valentin Tomberg. By their efforts, the historical facts from the lower record are extrapolated into symbolic facts and preserved in the book of Truth by the "living tradition" of clairvoyant occultists.

However more than just clairvoyant consciousness in the Imaginative tableau is required for a proper organization of historical facts into logical, symbolic conclusions. The act requires the rational faculties of the logical memory together with the moral qualities of an initiate that has purified his astral body from all passion, greed and selfishness. Nothing goes into the Book of Truth from such immoral perverts as C.W.Leadbeater, Pascal Beverly Randolph or Alister Crowley nor from the drug induced visions of Anna Kingsford or Dr. Timothy Leary.

In addition, the function of clairvoyant consciousness here in this Chronicle is not the same as a clairvoyant perception into the etheric and astral spheres of nature, which have revelations of an entirely different nature. I am reminded here of the comments of P.D. Ouspensky on his path thru the lower and higher thresholds of perception.

"I had come across in my reading...which I could recall neither deliberate falsification nor real clairvoyance. Thus, the clairvoyance of Leadbeater and Dr. Steiner, all the Akashic records, the descriptions of what happened tens of thousands of years ago in mythical Atlantis or in other pre-historic countries. The only difference was that I did not believe my experiences, while the Akashic records were believed and are believed by both their authors and readers.... It very soon became evident to me that it was all reflected, it all came from memory, from the imagination. This explains why it is that authors who describe Atlantis are unable with the aid of their clairvoyance to solve any practical problems relating to the present which are always so easy find."

This raises a very interesting problem that has always personally bothered me. For as Ouspensky further asks, "Why do they know everything that happened thirty thousand years ago and do not know what is happening at the time of their experiments, BUT IN ANOTHER PLACE.?" My feeling was, if these persons are so perceptive, tell me what is happening across the street? This is a poignant question, but misdirected, as there are two opposite processes of clairvoyance going on here. One is clairvoyance on the level of Imaginative consciousness that puts one in touch with our lower and higher Chronicles, which is by definition (as Ouspensky correctly pointed out), reflective from memory and not introspective. Introspective clairvoyance, on the other hand, also takes one into higher levels of consciousness, but thru the opposite path of perception of elementary nature spirits.

In addition to the lower and higher Chronicles, there is a Third Chronicle which contains what is of eternal value to mankind and the future earth evolution. It is called the "Book of Life" in occultism or the "Book of the Prophets" by Sister (Christian) Anne Catherine Emmerich. In what is perhaps Sister Christian's most extraordinary vision, she and her guardian angel travel in vision to the sacred "Mountain of the Prophets" in Tibet. Here she saw a long tent in which a table stood in the center. There was a figure that looked like Elias or (no surprise) John the Baptist and he was writing with a reed on a long scroll of parchment.

"In the middle of the table lay an immense book that could be opened and shut and it was to this book the man referred to see if the others were right...Right and left lay great books and parchments rolls on rods with knobs on

either end...He told me he was there to guard everything until the time would come to make use of it...Around the tent were other books and rolls, very old and precious. The figure told me that these books contained all the holiest things that had ever come from man. He examined and compared all and threw what was false into the fire near the tent." Later, after several other visits to the holy mountain, Sister Christian says that "I know why I went to the Mountain. My book lies among the writings on the table, all that is to be secured from destruction is there preserved."

Later, after several other visits to the Holy Mountain, Sister Christian says that "I know why I went to the Mountain. My Book lies among the writings on the table, all that is to be secured from destruction is there preserved."

This story relates four spiritual facts of concern. First, there is a "Book of the Prophets" which is the Third Akasha Chronicle and corresponds to the moral memory in man. It contains those pictures from the higher chronicle that deserve eternal value in the same sense that man's moral memory is eternal and passes on with him into devachan. From this book preserving the eternal moral memory of the world come the "imagination" which will pass over from this Earth manvantara to the future "Jupiter" manvantara. Here we can see this lives of the most glorious saints, martyrs and initiates and the writings of the Church Fathers long since lost or destroyed.

Second, on this table are many other manuscripts written by many other persons, which are first compared to the great book of the Prophets and if satisfactory, they are added to the great book. This would include the meditative writings and prayers of the great anonymous authors throughout history; the symbolic account of the great moral decisions that occurred throughout history, such as the prayers of St. Hedwig to turn back the Huns or the decision of Thomas Moore of Canterbury to defy King Henry the VIII; and the kind and gentle acts of charity performed by those of less than saintly stature, but nevertheless, remembered as part of the moral fabric of humanity

Third, there is an editor, in the cloak of Elijah/John the Baptist, who compares and edits the symbols from the Book of Truth and transcribes them into the Book of the Prophets. Why John the Baptist in this role? Because as Dr. Steiner said "The St. John Ego descended from the same holy region as that from which the soul-being of the Jesus child from the Gospel of St. Luke descended." This holy soul was also preserved with the Nathan Jesus soul in that Mother-Lodge of Humanity since the time of Adam and before the Fall of Mankind. Who better an editor than this arch-angelic sister-soul of Adam who has lived since the beginning of human time?

Lastly, the Book of the Prophets is preserved and guarded until "the time will come to make use of it" and this time is the Judgment Day of the Apocalypse. It is in every sense a book of Resurrection which will be viewed before the soul in final judgment in the same way that the soul in Kama-loka also views the book of his past life in judgment.

And, as the view of moral judgment during Kama-loka passes over into devachan, so too does the moral contents of this book of Resurrection pass over for mankind as world karma into the future Jupiter Manvantara.

Finally, a comment must be made on the nature of "prophecy" in itself and where it is found. Prophecy is being raised in Imaginative vision from the physical plane to the three higher planes of consciousness belonging to the Conditions of Form or in Theosophy, called the Globes. They are in their septenary nature as follows:

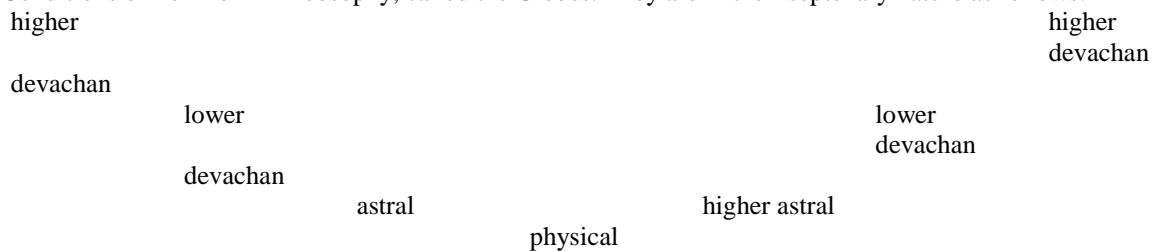

Here on the physical plane, our waking day consciousness of cognitive thought comes from the deeds of our Guardian Angels, while during sleep, we travel in our astral body and ego to the astral plane and live among the thoughts of the higher Angelic hierarchies. Our most profound Christian source of prophecy is the APOCALYPSE OF ST. JOHN. The seer of Patmos wrote this Book of Revelations about the "thunder and lightning" of the revelations of the Seraphim and Cherubim. As such, his source of revelation was from realms within devachan that are infinitely higher than where our normal day or night consciousness extends.

When St. John saw into these higher planes, he described the symbols of the Book of Prophets which appeared to him in Imaginative picture forms. For the future sixth cultural epoch (the Age of Aquarius), he saw the symbol of the Church of Philadelphia and for the future seventh cultural epoch (the Age of Capricorn), he saw the symbol of the Church of Loadicea. Likewise for the future Sixth Root Race following our present Aryan Root Race, he saw the seven seals, which represent the future seven cultural epochs of that Age. For the future Seventh Root Race, he saw the seven trumpets, whose angels represent the future seven cultural epochs of this last great Age. Afterwards, he

saw the end of historical time as we will know it, falling into death and destruction symbolized by the seven vials of wrath. On Judgment Day was read the Book of Prophets and from the life of Christ was read the Book of God. Finally, he saw the "descent of the Heavenly Jerusalem", after which comes the long pralaya before the coming of the next "Jupiter" planetary evolution.

The descent of the Heavenly Jerusalem is also a symbol which represents the descent of the plane of Higher Devachan (shown above) to the physical plane. What the seer St. John saw in vision in his day two thousand years ago was our moral symbols from the Third Chronicle which had been preserved up to that time. Sister Christian previously told us that the Book of Prophets was always being written, it is never finished. But certain moral symbols that are recognized as eternal form the vision of the Heavenly Jerusalem on the plane of Devachan, which in the future, will pass over unto the physical plane. Prophecy is the present vision of those eternal symbols located on the higher astral and devachan planes written in the Book of Prophets, the events of which by their intrinsic nature pass from the future into the present over the course of historical time.

finally, the correspondences found in the various spheres of macrocosm and microcosm are related as follows:

Human	Chronicle	Book	Bhutas	
Moral Memory	3 rd moral	Prophets/Life	Life	swallow
Logical memory	2 nd higher	Truth	sound	HEAR
Factual memory	1 st lower	Archives	light	see
			fire	
			air	
			water	
			earth	

THE FIFTH GOSPEL

There is in addition to the above three Chronicles, both a Fourth Chronicle and a fourth book. Here they do not have the same correspondences because they are based, not upon the human memory and principles, but upon the historical "Life of Christ." This book of the "Life of Christ" was first introduced to us by Dr. Steiner who called it the FIFTH GOSPEL. However, Steiner left the impression that this 5th Gospel was generally drawn from the Akashic record, without further distinction. In fact, the 5th Gospel forms a higher fourth chronicle and knowledge of it is very important to the understanding of the spiritual foundations of Christianity.

As is well known, the reason for the universally accepted religious practice of "waking the dead" comes from the occult fact of the dispersal of the etheric body immediately after death. In India, we still see the tradition of placing rice balls around the casket of the deceased in a room that has caged birds. The body is not cremated or buried until the birds, recognizing that the etheric body has fled the corpse, go to the casket and eat of the food placed there. A similar practice in the ancient Mediterranean cultures has a documented historical basis, but practiced with dogs instead of birds.

After death, the etheric body expands and slowly disperses into the etheric sphere over a period of about three days. During this time, like the familiar tales of the drowning man, the entire life-tableau of the deceased person passes before the soul's eye, in a series of pictures in reverse order. A holographic kernel of this life tableau, as eternal moral memory, remains over to accompany the soul into kama-loka or purgatory.

In *STUDIES OF THE NEW TESTAMENT* Valentin Tomberg explains the source of the distinct life of Christ with an explanation never touched upon by Steiner. He says that Jesus at His death renounced the vision of His life tableau. "He gave it up to humanity" and it later became the content of what the apostles saw in vision during the Pentecost event. This description gives many very important insights.

First, it explains the "source" of the "Life of Christ" that the apostles, Matthew, Mark, Luke and John, used to write down their gospel stories. A very strong argument has always been made by critics of the New Testament that how could the apostles write in the gospels about the passion and crucifixion of Christ if they (except John) were admittedly, not present to watch these events? This is a very poignant criticism.

However, at the Pentecost event, when the Holy Spirit descended, the flame, first raised the consciousness of the

apostles from a human/angelic level to that of an arch-angelic level. Second, by the light of the flame of the Holy Spirit, the apostles saw in Imaginative vision, the entire life of Christ as reflected in His etheric life tableau, that did not disperse back into the etheric sphere at His crucifixion, but was preserved and "given back to humanity."

For the ordinary man, our etheric body after death, disperses back into the general etheric sphere and our life tableau becomes part of the lower, historical Chronicle. But for the Christ, His etheric life tableau did not disperse back into the etheric sphere and become part of the lower Chronicle. His life tableau was preserved intact and given back to humanity as a separate higher Chronicle, known as the 5th Gospel. The effect of this occult fact serves three important purposes.

First, the 5th Gospel, when shown to the apostles at Pentecost, allowed them to write their separate accounts of the life of Christ without actually being present for such events as the passion and the crucifixion. This explains neatly why there are four different approaches to the life of Christ as reflected in the four gospels. Each apostle, writing with an arch-angelic intelligence, observed and transcribed what was symbolically important to each from their own individual perceptions. This is the real reason why the gospel accounts are all slightly different in account and in events and not all the same as if from one single observer.

Second, the 5th Gospel serves in vision as a source of inspiration to all great saints of Christianity. No person ever become a great saint without first, experiencing very personally a portion of the life of Christ during prayer and meditation, and second, without seeing in Imaginative vision, scenes from the life of Christ as preserved in the 5th Gospel.

For example, the stigmata occurs in great saints only because they have, first, personally experienced the pain of the passion of Christ thru prayer, meditation and spiritual exercises and, second, personally seen in Imaginative vision the scenes of the passion from the 5th Gospel. How do we know this to be true? In her biography, Sister Christian's author relates that,

"One day about noon, she was kneeling in contemplation...she beheld in vision the tabernacle door open and (Christ) issue from it in the form of a radiant youth. In His left hand, he held a garland, in His right hand, a Crown of Thorns, which He graciously presented to her in choice. She choose the Crown of Thorns. Then Jesus laid it lightly upon her brow and she pressed it firmly down. From that instant, she experienced inexpressible pains in her head."

Several days later, the blood from her stigmata began to flow and never stopped again during her lifetime.

Not all saints receive the gift of the stigmata from Christ as did Sister Christian. This is because not all saints decide to experience the passion and crucifixion. For different saints, different parts of the life of Christ are more important for personal and karmic reasons. But all great saints view some portion of the 5th Gospel. Those who write down their experiences are well known to Christianity, such as, St Theresa of Avila, St. John of the Cross, St. Bridget of Sweden, and the Ven. Mary of Agreda, Hildegard of Bingen and the Ven. Sister Emmerich. And there are others who do not write down their vision but simply say, as did St. Joan of Arc, that they have "read from the Book of God."

The last purpose served by the 5th Gospel is reserved for the future. As we discussed above, when the Judgment Day of the Apocalypse arrives, the Book of the Prophets will be opened and viewed before the souls in their Final Judgment. but, whereas the moral truths of the third Chronicle change during the life of each manvantara, the truths of the Book of God never change. What passes over as eternal truths of the human moral history from each of the future Earth, Jupiter, and Venus manvantaras, will change as does human history itself. However, the one time events of the life of Christ will never change and will always serve as the ideal life from which all our human lives will be compared.

THE IDENTITY OF THE TEACHER OF RIGHTEOUSNESS

Qumran

The discovery of the Dead Sea Scrolls at Qumran is the archaeological event of the millennium and unfortunately, their suppression from translation and publication is the spiritual crime of the millennium. Of what few scrolls that have been published, two sources of controversy have emerged.

The first concerns the identity of the authors of the Dead Sea Scrolls. The historical context of this time evolved from the division of the kingdom of Alexander the Great after his death in 323 B.C. into the two ruling dynasties of

the Ptolemies and the Seleucids. Palestine was ruled by one of these families until the second century B.C. revolt of the Maccabees, who liberated Jerusalem from Antiochus IV Epiphanies (175-164). This revolt was historically necessary to re-establish the high priest Zadokite line appointed by King David to fulfill the prophecy that the Messiah would be born of the House of David (the Solomon Jesus child).

During the Seleucid reign, the high priest office was appointed after being purchased by the highest bidder. The orderly succession of the Zadokite priest line failed when in 172 B.C. Onias III (a legitimate High Priest) was murdered in Jerusalem. Even if he was not assassinated, he was exiled to Egypt where either him or his son, Onias IV, built the Temple of Leontopolis. King Antiochus appointed Meneleus, a Hellenized Jew outside the Zadok line and in 165 B.C. Judas Maccabeus led a revolt to restore the faith. The Hasmonean dynasty of kings emerged and lasted until the Herodian dynasty beginning 37 B.C. During this time, numerous Jewish sects arose and competed for power and influence. These included the Zealots, the Sicarii, the Boethusians and the Hasidim. As described by the Historian Josephus, the three most dominant sects were the Pharisees, the Sadducees and the Essenes.

Only the Pharisees survived the Roman destruction of Jerusalem in 70 A.D. The Mishnah (200 A.D.) is presumably their literary legacy of Rabbinic Judaic Law. No text of any kind has ever been attributed to the written Hand of the Sadducees, so presumably they did not write the 800 manuscripts found in the eleven Qumran caves. By process of elimination, in this sense, the authorship of the Scrolls fall on the Essenes.

In another historical sense, the Natural History written by Pliny the Elder (23-79A.D.) cannot be ignored by even the most skeptical mind. He says, "On the west side of the Dead Sea, but out of range of the exhalations of the coast, is the solitary tribe of the Essenes, which is remarkable beyond all other tribes in the whole world, as it has no women and has renounced all sexual desire, has no money, and has only palm trees for company".

Frankly no better description of the monastic life of the Essene settlement can be given. After the discovery of the Scrolls in the nearby caves, an expedition was organized by Dominican priest Roland de Vaux to excavate the site of Khirbet Qumran. Although, scholars again disagree, arguing that the site could be a wealthy villa or military fortress, the excavations reveal an ancient monastery with a large scriptorium in which dozens of inkwells were found. As Qumran research has matured, the debate over the Essene/Sadducee origin of the Scrolls was put to rest by Harvard scholar and senior Scroll editor Frank Cross in 1966 when he unequivocally identified "the men of Qumran with their perennial house guests, the Essenes."

Now that most scholars agree Qumran was an Essene monastery, the second issue is the identity of the often referred Teacher of Righteousness (T of R).

Moreh Tzedek

Scholars have proposed two possible origins for the Essene community, one in Palestine and the other in Babylonia. The Palestinian theory recognizes that after the restoration of the Zadokite line to the Jerusalem temple by the Maccabees revolt, the Hasmonean line of kings were even more Hellenized than their predecessors. They signed agreements with the Roman Senate and employed Hellenized Jews as ambassadors. Instead of a return to orthodox Judaism, the Hasmonean kings increased Hellenization.

As a reaction to this usurpation, this theory supposes orthodox Jews rallied around a man referred to frequently in the Scrolls as Moreh Tzedek, the Teacher of Righteousness, made him their leader and reestablished their monastery at Qumran. Here in the desert they could observe the Mosaic Law and live a life of ritual purity until the day when the T of R could return to Jerusalem as the High Priest descended from Zadok. Indeed, the recovered Essene Manual of Discipline is a rigorous set of rules regulating the monastic life at Qumran. The Palestine origin theory is, of course, incorrect, particularly when considering how such a huge library at Qumran could have accumulated over only several generations.

The Babylonian theory of Essene origins traces this group back to the captivity after the destruction of the Temple in 596-586 B.C. The so-called Damascus Document of the recovered Scrolls suggests that the Essenes had been together long before the T of R appeared. Much of the legislation contained in the Damascus Document governs community living in a non-Jewish state, including regulations for dealing with Gentiles. It contains an historical summary that ends with the Babylonian Captivity. In addition, a "new covenant in the land of Damascus" is established by the survivors of the exile. Damascus is, of course, a symbolic name for the land of Babylon in Chaldea. That the Damascus Document was written by Jews living in the Babylonian exile and later carried with the Essences to Qumran after the liberation by King Cyrus is very reasonable to conclude.

The Michael Age

Particularly when you consider what a remarkable coincidence of spiritual streams converged during the Babylonian captivity, such as may not have occurred again until the end of Kali Yuga. During this forty-two reign of King Nebuchadnezzar (604-562 B.C.) at Babylon, we have first and foremost the centuries old mystery center of the Persian second cultural epoch. Leading to the great sanctuary of Marduk called E. Sag Ila, was the ceremonial Street of Babel. This processional path was seventy-five feet wide, with a retaining wall twenty-five feet high and lined

with an endless sequence of lion figures. Timely incarnated into this center of the Ishtar cult was the person known historically as Zarathustra. In his next incarnation (the cycle of Neros?) he was to become the Solomon Jesus Child of Nazareth and it was secret knowledge of this incarnation 600 years later that led the three Magi from Babylon to Bethlehem following the Star of Zarathustra. His task was as teacher to prepare for the Christ event of the Fourth Cultural Epoch of Pisces beginning 747 B.C.

Against this background of the Chaldean mystery center, we have at the same historical time, the birth of the Buddha mystery stream which was also to merge into the Christ event 600 years later when the Nirmanakaya of Buddha was given to the Nathan Christ child. When the Gautama Buddha achieved Nirvana, he passed his office as teacher to his successor, the Bodhisattva, who later was sent as the T of R to the Essene community at Qumran. Finally, the last element of the three-fold mystery stream merger was provided by the presence of the Jews in captivity. At this historical time, within two generations a whole series of former initiates of the Melchizedek mystery stream incarnated and streamen upon Babylon. First, Jeremiah, then Ezekiel, then Daniel and finally, Ezra, the scribe of Old Testament. Those prophets were descendants of the High Priesthood line of Zadek and bearers of the mystery wisdom imparted to Abraham from Melchizedek, the great sun-initiate.

This three-fold merger of mystery streams through their human representatives of Nazarathos, the Bodhisattva, and Ezekiel was, of course, only made possible by the archangel Michael. Prior to this time, Michael had been the guiding folk-spirit of the Jews until he ascended, in his turn, to the status of Spirit of the Age. Michael as representative of the Sun, whose angelic body would host the Christ ego as He descended through the heavenly spheres to incarnation during the baptism at the Jordan River, led a Golden Age which produced the genius of Plato and Pythagorus, the leadership of King Cyrus and ended with the scholarship of Aristotle and the reign of his pupil, Alexander the Great.

All told, the T of R weaves through the Dead Sea Scrolls in the same way that Dionysius the Areopagite weaves his way through the writings of St. Thomas Aquinas. Letters to him remind one of letters to the Friend of God from the Highlands. He led the battle in the Sons of Light against the Sons of Darkness. He was the teacher in the tradition of the heavenly high priest, Melchizedek, the sun Manu to whom the Scrolls (11QMELCHIZADEK) regard as an angelic being who lives forever as King of Righteousness. He announced that great events would soon come upon the last generation for those who believed in his covenant. He separated himself from the Jerusalem priesthood and like a prophet, his teaching was full of the Holy Spirit.

The New Temple

Foremost for the Essene community was the critique against the Second Temple built by Zerubbabel in 515 B.C. and the later reign of the Hasmonean dynasty. With Simon Maccabaeus, the previously separate sacerdotal (priestly) lines and the royal (kingly) lines were united into one dynasty of priest-king. This separation of offices was very important to the eschatology of the Essenes. For them, the material ideal was represented in the old second Temple in the Holy of Holies and the sanctuary. In the "new Temple", these are replaced by the "sacerdotal circle" and the circle formed by the rest of the faithful community. The fulfillment of these two circles was typified by the sons of Aaron and Israel. This concept is expressed by a passage from the Manual of Discipline which clearly shows the Essene Community anticipating the coming of TWO Messiahs, "There shall come the Prophet and the (two) Messiahs of Aaron and Israel."

The prophet is of course the T of R who comes in the strict sense of Ismaili Shiite prophetology with a revealed book, the Gospel of St. Matthew, and in the tradition of a priest of Melchizedek. St. John the Baptist came as the prophet of Aaron and Christ as the prophet of Israel. The unity of these two sacerdotal and royal lines was achieved in the birth of the two Jesus children and their unity into one person at age twelve, when the Zarathustra ego passed over into the body of the Nathan Jesus child.

The Essenes had truly felt that God had abandoned the children of Israel because of the usurpation of this sacerdotal lineage of Zadok by the Hasmonean dynasty and had also abandoned His presence in the second Temple by the occupation of the "wicked priest". The destruction of the first Temple of Solomon was caused by the sin of the Jews worshipping the pagan gods of Baal. The vision of Ezekiel described the Glory of the Lord (the Shekhinah) leaving Jerusalem. The prophecy of Ezekiel was the Divine restoration of a "new Temple" re-establishing the spiritual bond between Jehovah and his chosen people. The fulfillment of this prophecy rested in the Community of Qumran and the success of their Teacher in revealing these Divine truths as later preserved in the Gospel of St. Matthew. The historical purpose of the Essene community was to have at least a small group of people fully understand the immense significance of the coming of the Christ, both in an historical sense thru the teaching of the 3 X 14 generations of the St. Matthew Gospel and in a spiritual sense of the building of the new Temple.

As observed by professor Henry Corbin, the T of R was both a "final prophet" in the sense of a twelfth Iman revealing the esoteric meanings of all previous Divine revelations and a "new Ezekiel."

"Like Ezekiel, he combined three offices in his person: he was a priest of the line of Zadok, an inspired prophet, and a visionary of divine things...To the extent to which these three functions were also ascribed symbolically to the members of the (Qumran) Community, it can fairly be considered an Ezekelian community...of the new temple."

The Rabbinic Jesus Stories

Nineteenth century esoteric sources for the identity of the T of R include *LaScience des Esprits* by Eliphas Levi; *Royal Masonic Cylopaedia* by Mackenzie and *Isis Unveiled Vol. II* by Madame H.P. Blavatsky, all of which reference the Talmud and Toldoth Jesus stories which, first thought of as a blind but later became the source of the "fundamental error of the theosophists". The Madame H.P.B. relates in her Lucifer article, *The Esoteric Character of the Gospels*,

"Reference is made here to the Rabbinical tradition in the Babylonian Gemara, called *Sepher Toldos Jeshu*, about Jesus being the son of one named Pandira, and having lived a century earlier than the era called Christian, namely, during the reign of the Jewish king Alexander Jannaeus and his wife Salome, who reigned from the year 106 to 79 B.C. Accused by the Jews of having learned the magic art in Egypt, and of having stolen from the Holy of Holies the Incommunicable Name, Jehoshua (Jesus) was put to death by the Sanhedrin at Lud. He was stoned and then crucified on a tree, on the eve of Passover."

G.R.S. Mead (1883-1933) was the General Secretary of the Theosophical Society, private secretary to Madame H.P. Blavatsky, editor of several magazines and author of many books. He was a respected scholar of Gnosticism. In 1903 he published the study, *Did Jesus Live 100 B.C.?* He discusses the history and reprints some of the entire texts of the Talmud Balaam Jesus stories and the later mediaeval Toldoth Jesus stories.

The Talmud Jesus stories were the stock-in-trade Rabbinic Jewish objections to the Christian dogmatic tradition. In them, Jesus is referred to as Jeschu ben Pandera (or Pandira) or simply Ben Pandera and in the Lud stories as Ben Stada. He was born "a bastard son of a woman in her separation" of Miriam, the woman's hairdresser. He was said to have "practiced sorcery and seduced Israel and estranged them from God". During the Passover festival, he was stoned to death by the Sanhedrin and later hung on the Sabbath day.

By tradition, Jeschu had five disciples namely, Mathai, Nakkai, Netzer, Bunni and Jodah. That they were Therapeutae Healers in the Essene tradition is clear from the following story.

The son of Rabbi Jehoshua Ben Levi had the something stuck in his throat. He went to fetch one of the men of the Ben Pandera, to bring out what he had swallowed. A man came and whispered to him (a spell) in the name of Ben Pandera and he got well. What did you say over him? He answered: A certain verse after a certain man. He (Levi) said: It had been better for him had he buried him and not said over him that verse.

Obviously, this story shows the vehemence against the healing disciples when the Rabbi would prefer to have his son dead and buried rather than healed under the spell of Ben Pandera.

In the end, all five disciples were put to death. Their names have always been a source of speculation among commentators. Netzer certainly refers to the Nazars sect discussed by Madame H.P.B. in *Isis Unveiled* located in the village of Nazareth. Bunni may refer to Bannus, the Essene teacher of Josephus.

Mathai refers to the author of the Gospel of St. Matthew of the New Testament which occult history shows to have been written in Aramaic Hebrew before the birth of Christ. The other names are untraceable and as Mead suggests are meant for names for leaders of schools or sects existing at the beginning of the Christian era.

The medieval Toldoth texts have been classified into five general types, the only remaining printed texts are of Wagensiel (1681) and Huldreich (1705). "Toldoth Jeschu" literally means the Generations of Jeschu, a sort of Jewish life of Jesus or Jeschu. All these various types of recensions bear the scars of a bitter medieval polemical literature debate against the excesses of the Christians in persecuting the Jews. For these reasons, there is a great variety of titles, characters, storylines and dates extending from the sixteenth to nineteenth centuries. These narratives are more lengthy in dealing with the magician charges against Jeschu but shorter when dealing with the actual physical death. The following is a typical summary description.

First and foremost, Jeschu was a magician. In the sanctuary in Jerusalem "lay a foundation stone, God founded it and on it were written the letters of the Shem and whoever learned it, could do whatsoever he would". To protect this sanctuary, brazen dogs were bound at two iron pillars at the entrance and whomever entered and learned the identity of the letters, upon exiting, when the dogs bayed at him, the memory of the letters would vanish.

Jeschu entered the Holy of Holies, wrote down the letters on parchment, cut into his skin and laid the name in the wound under the cut flap of skin. Upon leaving the sanctuary, the brazen dogs bayed at him and his memory lapsed according to the tradition. However, when he went home, he opened the flap of skin and retrieved the Holy Name.

The Shem is the seventy-two syllabled name of God made up of 216 letters extrapolated from Exodus. From it is derived the 72 angels of Jacob's Ladder. Commonly known as Shem-Ha-Meforash, the correct pronunciation of this ineffable name of God was lost and not recovered until about 300 A.D. by the Kabbalists who gave it the title tetragrammaton. (JHVH).

The power of Shem is miraculous as Moses is said to have used it to part the waters of the Red Sea. Jeschu used its power to heal the sick, lame and lepers. The people of Galilee made clay birds, after speaking the letters of the Shem, they flew away as real birds. He once rolled a millstone to the edge of the sea and spoke the letters. He then placed the stone in the water and sat upon it as if floating in a boat.

Of course, these miracles of Jeschu didn't please the elders and priests any more than did the miracles of Christ please the Sadducees or Pharisees. What distinguishes the Talmud stories from the Toldoth stories is the unique parallel with the death of Christ. Andre Dupont-Sommer (1952) was absolutely right in his assertion that the life of the TR prefigured that of Jesus. Obviously, I do not know what the Dead Sea Scrolls say about the death of the TR, but the Toldoth stories narrate the final days as follows.

The elders befriended a man named Juda Ischariota and took him to the temple to learn and steal the letters of the Shem as Jeschu had once done. Juda then challenged Jeschu to a duel to the death in which they flew into the air like eagles and fought a bitter battle. However, since the power of the Shem was equal, neither could prevail. When they fell to the ground exhausted, Jeschu was captured.

The elders took Jeschu to the Queen (Helen) and asked that he be put to death. After interrogation, she released him back to the elders. They took Jeschu to the synagogue of Tiberias, where he was bound, tortured, given vinegar to drink as water and a crown of thorns set upon his head. To his rescue came his 310 apostates and brought him to the City of Antioch to rest.

On the Friday of Passover, Jeschu came into Jerusalem riding an ass with his apostates in glory. Another betrayer named Gaisa (the gardener) approached the elders and offered to identify and disclose the sanctuary where Jeschu was in repair. The elders went to the sanctuary (a school house) with Gaisa where Jeschu was discovered with four of his disciples, Mathai, Naki, Boni and Netzer. All were quickly put to death, the exact method of death being unclear.

Later, the wise elders of the Jerusalem temple tried to hang the body of Jeschu on a tree for public display. In every attempt the tree broke and it is unclear whether Jeschu was still alive uttering the Shem or if no tree would bear him for some mystical purpose. Finally, the body was laid over a large cabbage stalk (?) until the time of afternoon prayer, when the body was buried in traditional manner.

The apostates wept over the grave site for several days until it was discovered that the body was not inside the burial mound. Alarmed, the elders rushed to the Queen about the revelation. The Queen, worried that Jeschu fulfilled his own prophecy about ascending to heaven, ordered a great search for the missing body and promised her wrath if it could not be found. All Jerusalem was in mortal fear. Apparently, another gardener found the slain body and buried it in his yard, not telling anyone about the less than proper burial. Upon finding the body of Jeschu, the elders dragged the corpse around the streets of Jerusalem in public display and mock of the apostates.

It is an occult law that cycles repeat a subsequent time at a higher level, progress is a spiral not a straight line. This is the reason for the life of Jeschu Ben Pandera as a pre-figuration for the life of Christ.

To place an historical date on the Jeschu Ben Pandera legend is as Mead suggests, a jungle. The oral tradition of the Talmud is estimated by scholars to have been written down between 400-600 A.D. The motive to deceive, blind or otherwise conceal the date of the life of Jeschu is best described by Justin Martyr as "The Jews make war against the Christians as against a foreign nation."

In the Babylonian Gemara, a story is told twice that, "When King Jannai directed the destruction of the Rabbis, R. Joshua Ben Perachiach and Jeschu (Ben Pandera) went to Alexandria". Tannai or Jannaeus (John) was of the Maccabaeon line of Kings and reigned over the Jews at 104-78 B.C. His wife Salome later reigned at 78-69 B.C. and their rule was generally considered a golden age for the Pharisees.

If there is any historical basis for the passage, Joshua Ben Perachiach probably fled to Alexandria in 87 B.C. and was recalled in 78 B.C. He exists as an historical character and considered the greatest and most learned Rabbi of his time. This would place the age of his student Jeschu in the First Century B.C.

Tracing the historical date of the life of Jeschu in the Toldoth stories is more difficult. The contradiction appears in two popular versions placing Jeschu in the days of Joshua ben Perachiach (as in the Talmud) and another placing him (as in our narrative) in the days of Tiberius and Pilate. The reason for this probably arises from the confusion of equating Jesus with Jeschu. They are two different persons living in two different centuries! In the great medieval debates, inquisitions and persecutions by the Dominicans, the Jews probably confused the issue by asserting that their Talmud Jeschu was actually the Christian Jesus, thereby downplaying the Messianic character of Jesus, including the virgin birth, the crucifixion and resurrection. Remember, the persecuted were fighting to save their lives from the worst torture and burning at the stake. Also, if the Talmud Jeschu was originally an oral esoteric tradition among the Essenes, it was only a matter of time before the revealed exoteric version was profaned. This may in fact be the case with the genealogy of Jesus given by Epiphanius.

The so-called "Riddle of Epiphanius" is this. On the one hand he gives a very clear and unambiguous birthday for Jesus as "The Saviour was born in the forty-second year of Augustus, King of Rome... and on the 6th day of January after thirteen days of winter solstice and the increase of light and day...For it needs must have been that this should be a figure of our Lord, Jesus Christ Himself, and of his twelve disciples, who made up the number of the thirteen days of the increase of the light."

Epiphanius would count the first year of Augustus (Octavian) from the date of the death of Julius Caesar at 44 B.C. and thereby placing the birthdate of Christ in the year of 2 B.C. This birthdate is in close accord with the Canonical date of Christ, which custom began with Dionysius Exiguus.

On the other hand, Epiphanius gives a contrary birth date in a polemical he wrote defending the genealogy of Jesus coming from the House of David, in fulfillment of biblical prophecy. In arguing for the unbroken succession from David, he says, "Now the throne and kingly seat of David is the priestly office in the Holy Church...The throne of David continued by succession up until that time - namely, till Christ Himself - without any failure from the princes of Judah, until it came unto Him...For with the advent of the Christ the succession of the Princes of Judah, who reigned until the Christ Himself, ceased...The order of succession failed and stopped at that time when he was born in Bethlehem of Judea, in the days of Alexander, who was of high-priestly and royal race; and after himself and Salina...a foreign king, Herod, and those who were no longer of the family of David, assumed the Crown."

Now, this Alexander and Salina are the Greek names for King Jannai and his wife Salome, who succeeded him as discussed in the Babylonian Gemara-Talmud. Together, they reigned from 104 B.C. to 69 B.C., the era of Jeschu Ben Pandera not the era of Christ!

Thus, we have the identical problem previously mentioned in relation to the Toldoth stories wherein Jeschu or Jesus was placed in one version in the days of King Jannai and in another version placed in the days of King Herod. This contradiction is more problematical since Epiphanius, although a Jew by birth (about 315 A.D.), was a youthful convert to Christianity and canonized a saint by the Roman Catholic Church for his pious writings on Nicene orthodoxy.

No other historical writer has placed such an exact date for the birth of Christ (January 6th, etc.) and also demanding the birth date as prophecy fulfilled in the transfer of kingship offices from Jannai to Jesus.

In explanation, I suppose it is possible that there was a deliberate mis-translation in the names of Jeschu (Ben Pandera) and Jesus. Thus, the transfer of office went from Jannai to Jeschu to Joseph to Jesus. This reason is born out by Mead when he states that the name of Panther (Pandera) was inserted in the genealogy of Jesus when Epiphanius otherwise discussed the family history of Joseph.

Joseph, says Epiphanius, was the son of Panther (Pandera) and Panther was born about 100 B.C. Now Panther is a name given for the soldier in several Talmud Jesus stories described as the paramour of the mother of Jesus when she was in separation. We also see the name of Panthera written by Origen in his polemics against Celsus. Mead says that Panther and Pandera are the one and the same person and his research shows that the name Panthera was erased from the oldest Vatican manuscripts of Origen.

Epiphanius further states that Joseph had four sons and two daughters from his first wife before his second marriage to the Virgin Mary. These step-brothers and step-sisters of Jesus were named Jacob, Jose, Simeon, Judas, Maria and Salome. Jacob became the first Christian bishop and was martyred about 63 A.D.

In summary, we see a rather incredulous tale from the Talmud and Toldoth Jesus stories, and from Epiphanius the genealogy of Joseph and Jesus with step-brothers and step-sisters of Jesus. Now, deliberately weaving through the confusion and contradictions, let us pick a thread as follows.

About 100 B.C. a person named Jeschu Ben Pandera lived under the kingships of Jannai and Solome. He was a close student and pupil of the very learned and respected Rabbi R. Joshua Pen Perachiach with whom he travelled to that great mecca of magic and occult learning Egypt. After stealing the Shem, he travelled throughout Judea performing miracles and gathering a group of apostates numbering 310 persons. During Passover week, he rode into Jerusalem on the back of an ass, was betrayed and later killed with several of his close disciples. His body was hung on a tree and later, when re-discovered, dragged through the streets in public humiliation. He was descendant from the priestly line of kings and his son named Joseph became the step-father of Jesus and the wife of the Virgin Mary. Joseph had six children prior to his adoption of Jesus and these children became the step-family of Jesus.

The traditional gospels, of course, do not relate such an incredible tradition, however there are many gospels and other writings not included in our modern New Testament. Mead suggests as a partial answer to the riddle of Epiphanius that, "He knew of an ancient tradition which declared that the Christian derived from the Essenes, that Jesus himself was an Essene, and that the church further (Epiphanius) wished to safeguard the doctrinal tradition now stereotyped by the Ecumenical decisions at Nicaea, by working into his treatise an argument against the 'heretical' tradition, should it ever have the hardihood to raise its head again". As we shall see, Mead was absolutely correct in his remarkable insight into the mind and intent of Epiphanius.

The Boddhisattva Question

On the one hand we have to politely say that the Toldoth and Talmud Jesus stories are intentionally misleading and scandalous by Christian standards. While on the other hand, there is an occult secret hovering around the identity of the man named Pandira. Why would the leading occultists of the 19th. century, especially Blavatsky and Levi, consider this man named Pandira to be the actual Jesus Christ ?

In the 20th. century a solution was offered by Emil Bock who said, "The fundamental Christological error of the Theosophists was the confusion of Jesus Christ with Jeschu ben Pandira." Even Annie Besant in her book about esoteric christianity said that Jesus was born "about 105 B.C." It was not until the lecture series entitled ESOTERIC CHRISTIANITY given by Dr. Steiner in the years 1911-12 that he disclosed the true mission if the Bodhisattva and the errors of the 19th. century occultists. Yes, Steiner's ESOTERIC CHRISTIANITY was a direct response to Besant's ESOTERIC CHRISTIANITY in the same sense that his THEOSOPHY was in direct response to her THE ANCIENT WISDOM.

Now that the error had been defined and corrected, why was the source of the error to be found in the Jewish Toldoth and Talmud stories ? Instead of the giving the obvious explanation that comes from common sense and not occult rocket science, look at the description of the destruction of the Temple of Jerusalem after the Crucifixion given by Sister Anne Catherine Emmerich:

" Terror fell upon all at the sound if Jesus' death cry, when the earth quaked and the rock neath the cross was split asunder. A feeling of dread pervaded the whole universe. The veil of the Temple was on the instant twain, the dead arose from their graves, the walls in the Temple fell, while mountains and buildings were overturned in many parts of the world...The two great columns at the entrance of the Holy of Holies in the Temple fell in opposite directions...The beam which they supported gave way and the great curtain was, with a hissing noise, rent from top to bottom so that, opening on either side, it fell...The people could now see into the holy of Holies...An apparition of the murdered high priest Zacharias was seen...Jeremias appeared at the alter and uttered words of denunciation...There were about one hundred deceased belonging to all periods of time who arose in body from their shattered tombs in Jerusalem."

Annas and the High Priest Caiaphas were the true conspirators seeking the death of Jesus. They had been secretly plotting against him since the ministry began at the request of the Pharisees, the Sadducees and the Herodians. Now that their plot for the murder of Jesus prevailed, the words of the crowd, "Crucify Him" rang in their ears as the Temple was being rent asunder and the karma of the death of the Son of God descended upon the Jewish race. Why the Rabbinic Jesus stories ?

"Annas was so terrified that he became like one bereft of reason. He fled from corner to corner through the most retired apartments of the temple. I saw him moaning and crying, his muscles contracted as if in convulsions...Annus was like one possessed. He was obliged to be confined and he never again appeared in public. Caiaphas became like a madman devoured by secret rage...These speeches and apparitions in places in which Caiaphas or the priests alone had access, were HUSHED UP OR DENIED. IT WAS FORBIDDEN TO SPEAK OF THEM UNDER PENALTY OF EXCOMMUNICATION."

Jeschu ben Pandira

About forty years before the discovery of the Dead Sea Scrolls, Rudolf Steiner clearly identified the T of R as well as the spiritual task of the Essene community.

In THE GOSPEL OF ST. MATTHEW(1910), he says,

"During the reign of King Alexander Jannaeus (about 103 to 76 B.C.), a certain Individuality was sent into the communities of the Essenes to be their guide and leader. This Individuality was the leader of the Essenes about a hundred years before the appearance of Christ Jesus on the Earth.

He is also known in Talmudist literature under the name of Jesus, the son of Pandira, Jeschu ben Pandira. He was a great and noble personality, about whom inferior Jewish literature has woven all kinds of fables that have been recently revived, and he must not be confused, as some Talmudist have confused him, with the 'Jesus of Nazareth'.

We also know that he was accused of blasphemy and heresy by those to whom the teaching of the Essenses were anathema, and after being stoned was hanged on a tree, in order to add to the punishment, the stigma of infamy."

The purpose of Steiner's disclosure of this 2,000 year old occult mystery was to weave the Buddhist stream into esoteric Christianity. The last physical incarnation of the Gautama Buddha occurred about 600 B.C. when that individual achieved the rank of Buddhahood and entered Nirvana. As such, he passed his office as a teacher of humanity onto his successor who has the rank of Bodhisattva. There are twelve such Bodhisattva's who form the White Lodge around the thirteenth, the Christ. Each Bodhisattva is a teacher of humanity until he reaches the rank of a Buddha, after which he never again incarnates in a physical body. Since 600 B.C., this Bodhisattva, who succeeded the Gautama Buddha has been incarnating on earth as a representative of the Buddhist esoteric stream and will do so for the next 2,400 years until he rises to the rank of the next Buddha known as the Maitreya Buddha.

Steiner says that this Bodhisattva sent Jeschu ben Pandira into the Essene communities to prepare for the two Christ Children birth event. Both the Chaldean mystery school at Babylon and the Essene community at Palestine knew of the secret teaching of the preparation of the physical, etheric and astral bodies through the forty-two generations descendant from Abraham. Jeschu Ben Pandira taught this secret to the Essene communities and actually had pupils experience clairvoyantly the descent of the Christ being through the forty-two stages. He taught that the time was very near when the blood line would be ready for the incarnation of Zarathustra in the Solomon Jesus Child. Steiner also confirms the names of the five disciples of Ben Pandira as preserved correctly in the Talmud. In addition, he reveals the mission of the disciple Netzer as cultivating a secluded Essene sect which later in the Bible came to be called Nazareth.

Steiner also reveals the mission of the disciple Mathai and the secret of the gospel of St. Matthew. Mathai was that pupil in whom the secret of the preparation of the blood through forty-two generations for the incarnation of Zarathustra was preserved. This secret is exoterically disclosed in the first chapter of the St. Matthew Gospel wherein the blood line of the Jesus child is traced through the 3 x 14 generations from Abraham to David, David to the Babylonian captivity and then to the birth in Bethlehem.

Mathai is also the author of the St. Matthew Gospel. Biblical scholars are quick to forget the historical fact that the New Testament Gospels of Mark, Luke and John were written in Greek but the St. Matthew Gospel was written in Aramaic, the language of Christ. Remember, in the fourth century, St. Jerome was asked by the Church Bishops Chromatius and Heliodorus, to compare and translate the Septuagint Greek version with the original Hebrew version preserved by the Nazarenes in their library at Caesara. Jerome relates that the text was unintelligible to him being, composed of secret symbolic script which he could not translate (since he was not initiated into the mysteries). He admits that this genuine apostolic writing was written in Chaldaic language with Aramaic letters "by the hand of Matthew himself" and was intended to be kept secret and not openly written (translated).

Thus, this Gospel pre-dates the birth of Christ and the events described in it serve as a pre-configuration "according to scripture" of the birth, life and death of Christ. In another sense, the life of Jeschu Ben Pandira is a pre-configuration of the life of Christ, which correspondence was discussed in a publication by the French scholar Andre Depont-Sommer in 1952 as follows:

"The Galilean Master, as He is presented to us in the writings of the New Testament, appears in many respects as an astonishing reincarnation of the Teacher of Righteousness. Like the latter He preached penitence, poverty, humility, love of one's neighbour, chastity. Like him, He prescribed the observance of the Law of Moses, the whole Law, but the Law finished and perfected, thanks to His own revelations. Like him He was the Elect and Messiah of God, the Messiah redeemer of the world. Like him He was the object of the hostility of the priests, the party of the Sadducees. Like him He was condemned and put to death. Like him He pronounced judgement on Jerusalem, which was taken and destroyed by the Romans for having put Him to death. Like him, at the end of time, He will be the supreme judge. Like him He founded a Church whose adherents fervently awaited His glorious return".

4Q448

In a recent issue of the BIBLICAL ARCHAEOLOGY REVIEW there is an article which confirms the 100 B.C. date of Steiner and the lifetime of the Toldoth Jesus under King Jannaeus.

Qumran Scroll No. 4Q448 is a leather fragment about three inches wide and six inches long. It is a psalm and was originally published in 1977 in untranslated form. It was not translated because it was printed in semicursive script which is very difficult to translate. For the past fifteen years, several scholars, including John Strugnell, have been trying to decipher it. Recently, an acceptable version was published and identified a reference to King Jonathan. Now King Jonathan is the same as King Jannaeus identified in the Babylonian Gemara of the Talmud Jesus Stories. Since the above publication of G.R.S. Mead, coins have been found in which one side says in Greek, "Alexander the King" and on the other side in Hebrew the inscription reads, "King Jonathan". These coins positively identify Alexander Jannaeus as the King Jonathan of the Hasmonean dynasty who reigned between 103 and 76 B.C. Scholars consider this translation significant because for the first time a Qumran scroll makes reference to an historical figure whose life can be exactly dated to the first quarter of the first Century B.C. It is important to us because it dates Jeschu Ben Pandira of the Talmud stories to the reign of King Jannaeus which is in accord with the 100 B.C. date given by R. Steiner.

The Maitreya Bodhisattva

A last clue on the trail of the Bodhisattva comes from the unlikely source of the visions of Sister Anne Catherine Emmerich, when (above) describing the destruction of the Temple says:

"I had also a glimpse of other deceased persons who arose here and there in different parts of the Holy Land, appeared to their relatives and bore witness to Christ's mission. I saw, for instance, Zadoch, a very pious man, who divided all his wealth between the poor and the Temple and FOUNDED AN ESSENIAN SECT NEAR HEBRON. He was one of the last prophets before Christ. He had waited very earnestly for the appearance of the Messiah, he

had many revelations upon the same, and communication with the ancestors of the Holy Family. This ZADOCH, who lived about ONE HUNDRED YEARS before Jesus, I saw arise and appear to several persons in the region of Hebron. I saw once that his soul was among the first to return to his body, and then I saw all those souls walking around with Jesus, as if they had again laid their body down."

Now it can be said that the name Zadoch bears little relationship to the name Jeschu ben Pandira. However, prior to the discovery of the Dead Sea scrolls, Pandira was not only the exoteric but also the only esoteric name handed down in writing for the name of this Bodhisattva. Even Dr. Steiner used this name. However, since the discovery of the scrolls, we now know that the T of R was called, MOREH TZEDEK. The term Zadoch as used by Sister Emmerich refers of course to the generic names given over the generations to High Priests of the Temple descended from King David's original High Priest, Zadok. The term Tzedek, as in Melchizedek, refers to the Hebrew name of the planetary spirit of Jupiter.

That Moreh Tzedek was a High Priest incarnated in the Zakokite line of Temple priests, seem reasonable. That Sister Emmerich connects "Zadoch" to the founding of an Essene sect and that he lived about 100 years before Christ, is too coincidental to dismiss as a misnomer.

There are more than one Bodhisattva's that incarnate into the stream of the spiritual guidance of mankind. However, Moreh Tzedek is a very special one in the generational line of the future Maitreya Buddha, which Dr. Steiner said will incarnate again about the beginning of the 20th. Century.

SYMBOLS OF TWELVE-THE ZODIAC

The Tropical Zodiac The tropical zodiac is a secondary cycle to that of the sidereal zodiac. Taking the celestial sphere as one great circle and the earth's sphere as another great circle, the equator of the earth coincides and is concentric with the celestial equator .

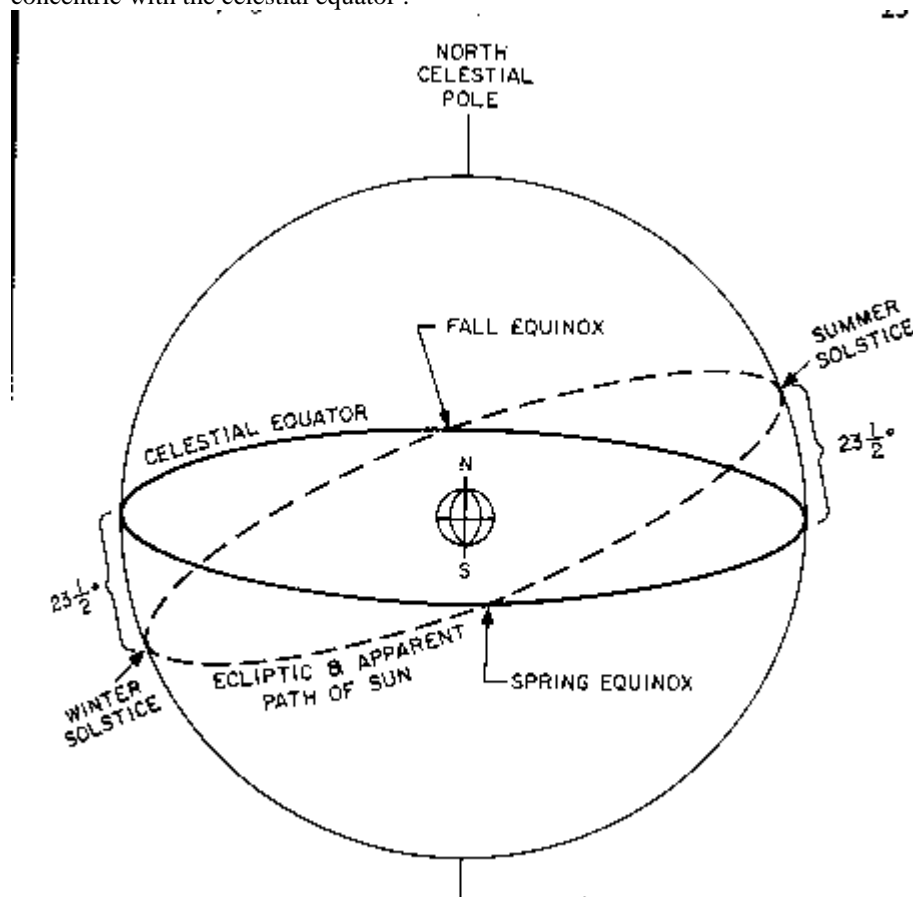

2.4 The celestial equator.

the sun in it's apparent eastward motion describes a circle on the celestial sphere we call the ecliptic. All points of the celestial equator have 0 degrees declination; points above the equator have positive declination, ranging from 0 degrees to +90 at the north celestial pole; points below the equator have negative declination, ranging from 0

degrees to -90 at the south celestial pole. The declination of the sun during its annual motion along the ecliptic is positive when above the equator and negative when below the equator. In the summertime when the sun is high overhead, the declination is positive and in the wintertime, when the overhead arc of the sun is much lower, the declination is negative. This implies that twice during the year, its declination is 0 degrees, since it must pass thru 0 degrees in going from positive to negative and vice versa. Thus, the sun is directly on the equator at these two intersections of the circle.

If we call these two points the equinoxes, the VERNAL EQUINOX occurs when the sun passes from negative to positive declination (from south to north of the celestial equator). This occurs about March 21st each year and is called the "First of Aries." Likewise, the AUTUMNAL EQUINOX occurs when the sun passes from positive to negative declination (from north to south of the celestial equator) and this occurs about September 23rd each year. The term SOLSTICE (meaning sun-stop) refers to the position of the sun at maximum and minimum declination. When the sun's declination is at a maximum (+23 1/2 degrees) and is directly overhead, this is called the Summer solstice and occurs about July 22nd each year. When the sun's declination is at a minimum (-23 1/2 degrees), this is called the winter solstice and occurs about December 22nd each year.

The motion of the sun along the path of the ecliptic during the 365 day cycle of the year passes thru a band on constellations called the ZODIAC. As we discussed in THE SEPTENARY IN THE AGES AND EPOCHS OF MANKIND, each of the 12 constellations within 30 degrees of the celestial equator is divided into equal parts of a circle of 30 degrees for each house of the zodiac. This is done more for convenience since some houses are shorter or longer than exactly 30 degrees.

Taking as a model the sun's motion in declination, thru the 12 houses of the zodiac, the Ancient Wisdom taught of the Twelve Steps of the Sun. Beginning at the vernal equinox, the first three steps in positive declination were the houses of Aries, Taurus and Gemini, leading to the summer solstice. The next three steps in positive declination were Cancer, Leo and Virgo, leading to the autumn equinox. Here the sun's declination passes from positive to negative. The next three steps in negative declination were Libra, Scorpio and Sagittarius, leading to the winter solstice. The final three steps in negative declination were Capricorn, Aquarius and Pisces, leading back to the vernal equinox.

Although the houses are in fact denoted from the geometry of the sidereal zodiac, as opposed to the tropical zodiac, it is an easy step to describe the correspondence between the 12 steps in declination and the 12 houses of the sidereal zodiac. However, it is very important to realize that the tropical zodiac is an horizontal path in latitude describing the sun's motion along the plane of the ecliptic, and as such, describes an ANNUAL motion corresponding to the yearly cycle of the seasons of nature. The declination measures only the sun's height or altitude, which in turn effects, by degrees of light and heat, the qualities of the four seasons. The yearly cycle of the tropical zodiac is one of growth-in-spring; expansion-in-summer; decay-in-fall and contraction-in-winter.

The Sidereal Zodiac

Since the tropical zodiac corresponds only to the annual motion of the sun in declination, it is a secondary cycle to the larger cycle of the sidereal zodiac. If we use the plane of the ecliptic great circle, instead of the celestial equator circle as the fundamental great circle, we create an ecliptic coordinate system, in which the coordinates are celestial latitude and celestial longitude. In this way an object in the sky is measured in relation to its distance (along the ecliptic) from the vernal point, to the point where the great circle passing thru pole of the ecliptic and thru the object, meets the ecliptic.

As a source of measures, the axis between the two first magnitude stars of Aldebaran, located in the middle of Taurus, and Antares, located in the middle of Scorpio, divide the zodiac in equal halves. Then, using this very visible fixed star axis, 12 fixed star constellations are defined at 30 degrees each in length around the ecliptic belt. Thus, against a background of stars, the sidereal zodiac gives a coordinate system for the movements of the sun, moon and planets with a celestial frame of reference of celestial longitude, instead of the merely horizontal motion of the sun thru the tropical zodiac.

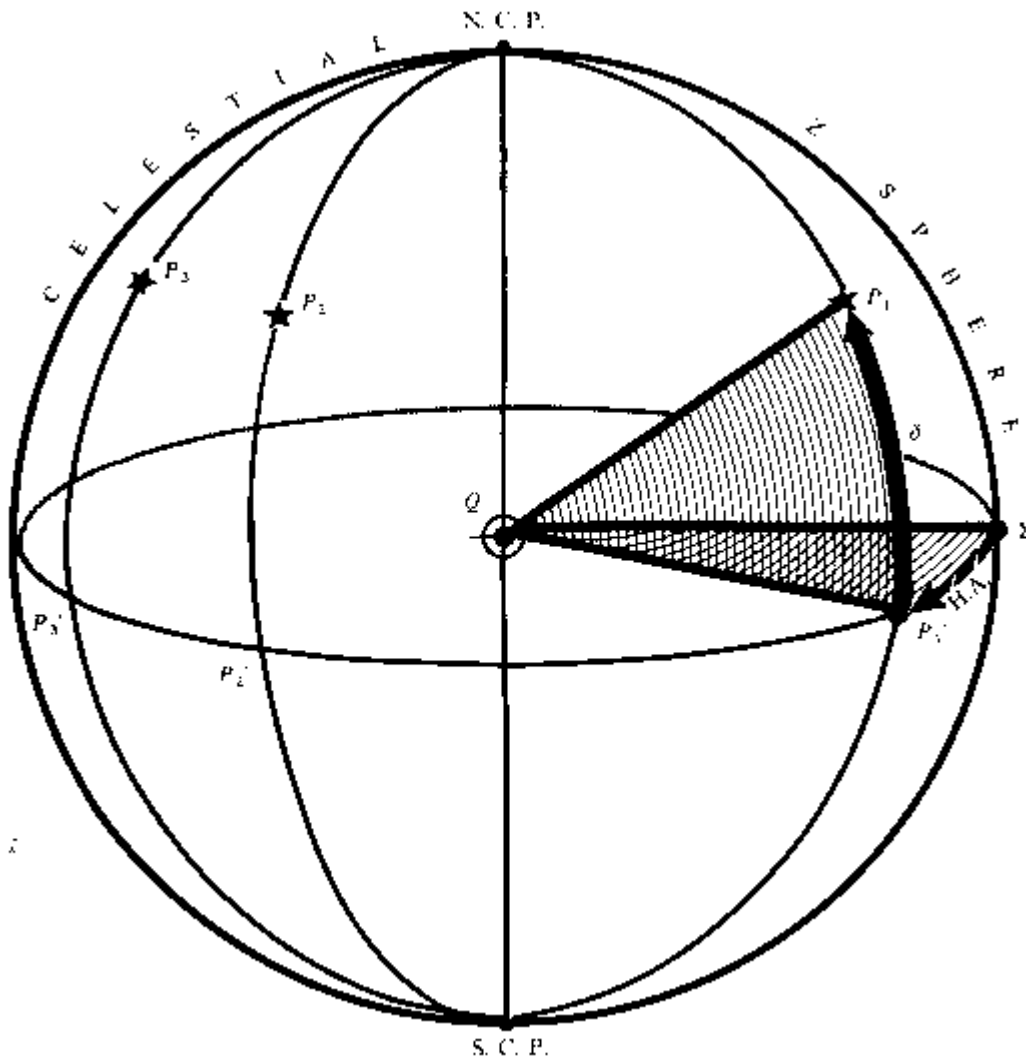

Unfortunately, the sun can not be measured against the celestial background, so there is always extrapolation from other planetary positions, such as the full moon, from which the sun is always in opposition. The sidereal zodiac is first and foremost a celestial clock measuring celestial time. As we have discussed many times elsewhere, because of the precessional motion of the sun

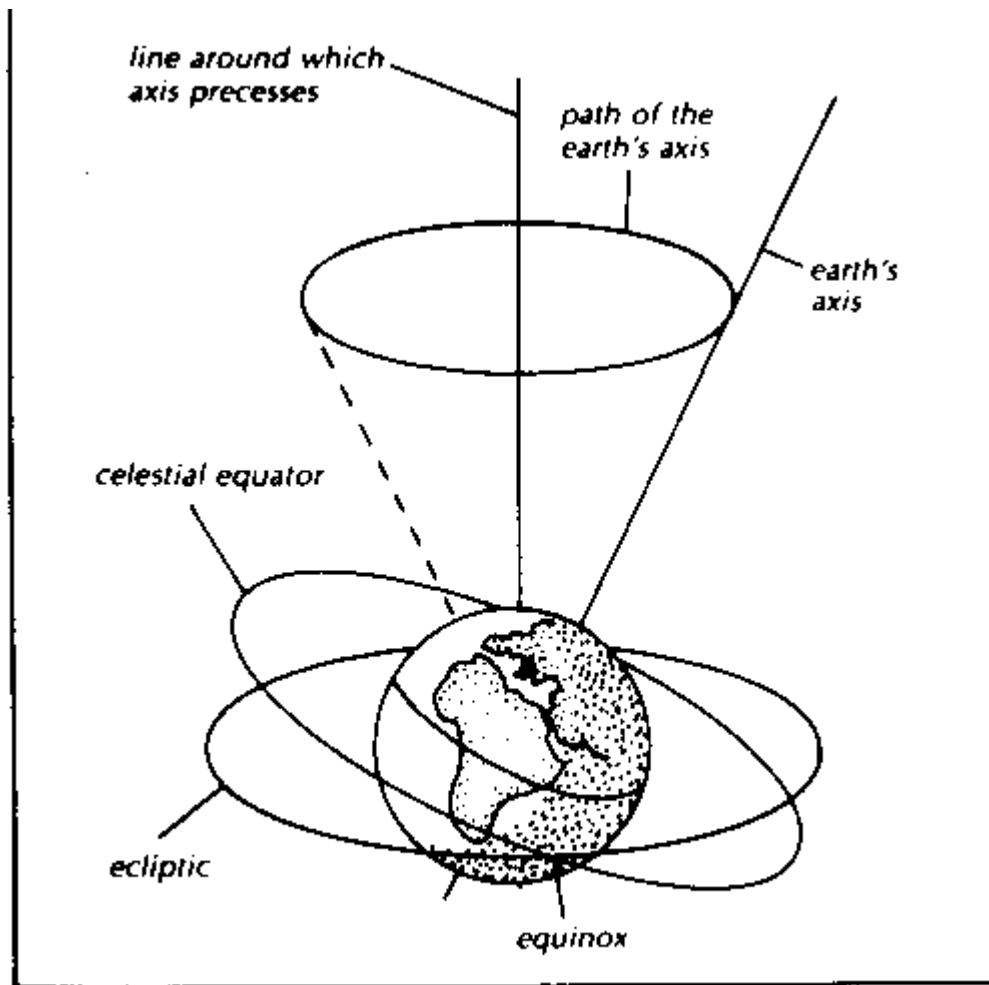

5.3 The precession of the equinoxes.

thru the sidereal zodiac ,

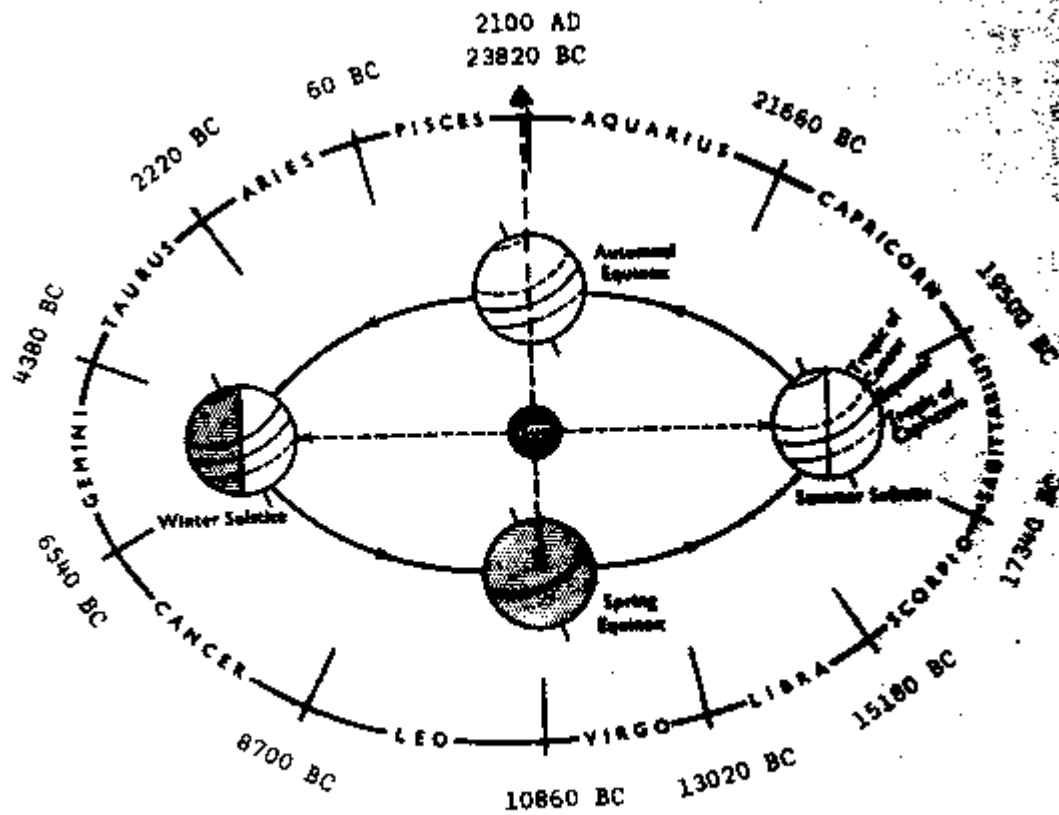
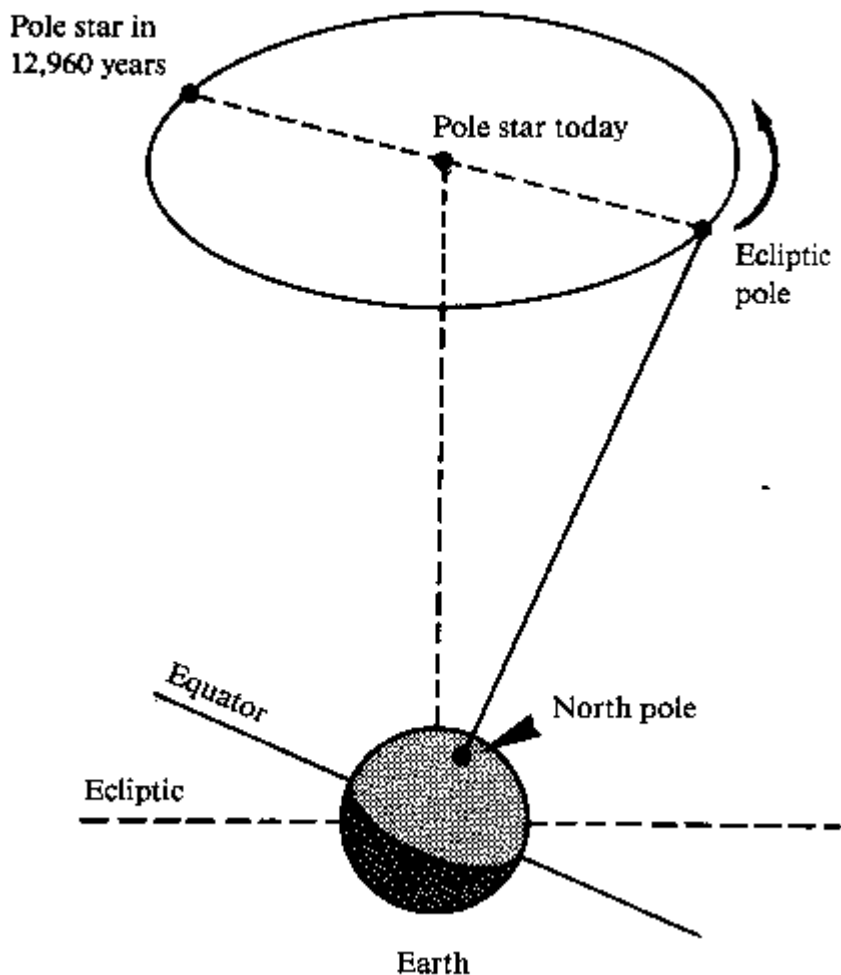

Fig. 98

the sun measures 2,160 years thru each house of the zodiac, for a total complete cycle of 25,920 years, known as the solar sidereal great year .



As of February 10, 1983, the sun enters the vernal equinox at 5 1/2 degrees Pisces. In the tropical zodiac, this point is fixed at 1 degree Aries on about March 21st. In the sidereal zodiac, 1 degree Aries occurs on April 15th, Taurus on May 15, Gemini on June 16, Cancer on July 17, Libra on August 18, Virgo on September 17, Libra on October 18, Scorpio on November 17, Sagittarius on December 17, Capricorn on January 15, Aquarius on February 14, and Pisces on March 15.

Because of the differences of these dates, when a tropical astrologer casts your horoscope, chances are 5 to 1 that s/he places your birth date in the wrong house. To determine the correct house in the sidereal zodiac of your birth date, begin at the start of the current astrological age of Pisces in the year 215 AD. Using my birth date of 7-21-50, subtract 215 years from 1950 = 1735 years. Divide by the precessional rate of 1 degree every 72 years, which equals 24 degrees. The tropical date of July 21st equals about 28 degrees Cancer. Deduct 24 degrees from the 28 degrees and my actual birth date is about 4 degrees Cancer in June, which means that for myself, I am still born in Cancer, but this will not be true for anyone born, since 1950, less than 24 degrees into any particular house.

The Planetary Rulers

Against this background of the solar sidereal great year, the Ancient Wisdom teaches of the Planetary Rulers of the signs of the zodiac, again a product of the Sumerian/Chaldean star wisdom. The method is sort of an incorporation of the law of Seven into the law of Twelve such that each of the five planets rules two houses and the sun and moon rule one house each, as follows:

12 cycles of 2,160 years each

Cancer	Moon	Leo	Sun
Gemini	Mercury	Virgo	Mercury
Taurus	Venus	Libra	Venus
Aries	Mars	Scorpio	Mars
Pisces	Jupiter	Sagittarius	Jupiter
Aquarius	Saturn	Capricorn	Saturn

Thus, each astrological age of the sidereal zodiac, lasting 2,160 years, is governed by the spirit of the what the Ancient Wisdom called a Planetary Ruler, whose task is to influence the spiritual guidance of humanity. In a very real sense, they take orders from the above hierarchy of the Spirits of Form and direct orders to their lower hierarchy of Archangels, as leaders of nations. In Christian Esoterism, these planetary rulers are now called the angelic hierarchy of the Archai, also known as Spirits of Personality/Principality/Spirits of the Age. Hegel referred to them as a Time Spirit or Zeitgeist.

Christianity, being born in the astrological age of Pisces, is ruled in the superior by Jupiter and in the opposition by Virgo and its ruling planet, mercury. Thus, Christian symbols of the Fish (Pisces) and the Virgin (Virgo) pre-date those of the cross. In addition, there is the miracle of the loaves (Virgo was represented by carrying a sheaf of wheat) and fishes and the symbolic Greek name for Christ as Ichthus, the Fish.

The 36 stars of the Sumerian Sun

Whereas the tropical zodiac has 12 steps of the sun, the sidereal zodiac has 36 steps of the sun, known as the decans. Most historians give the origin of the 36 decans to the ancient Egyptians, who modified the original Chaldean zodiac, when it was introduced into Alexandria at the beginning of the Hellenistic age. As evidence of this, one need only look at the circular zodiac found on the ceiling of the Egyptian temple of Dendera, now in the Louvre museum. A later rectangular zodiac was found in the temple of Khnum near Esra, which was subsequently destroyed. It is to me more likely the Chaldean zodiac already contained the decans before it was transmitted to Alexandria. The ancient Sumerian zodiac called UL-HE meant "shiny herd" as opposed to the more familiar later Greek ZODIAKOS KYKLOS meaning "animal circle." Indeed, the Babylonian zodiac is much older than the 5th century BC date given by Robert Powell and other researchers.

One very obvious reason for the antiquity of the Babylonian zodiac was discussed, infra, in David Ulansey's book, THE ORIGINS OF THE MITHRAIC MYSTERIES. Here he conclusively proves that the symbol of Mithras slaying of the bull, as depicted in the hundreds of tauroctony figures, was a cosmological symbol for the precessional transition from the age of Taurus to the age of Aries. This signifies a change in the ruling planetary Archai. We know from the previous discussion in the AGES OF MANKIND, that the precessional age of Taurus began about 4106 BC and ended in 1946 BC with the commencement of the age of Aries. Although the Mithraic mysteries did not become exoteric until the first century AD, scholars, like Franz Cumont, attribute the source of the cult to the ancient Iranian god Mithra, whose esoteric teachings were later transplanted into the Roman culture. We know that on the ceilings of the caves where Zarathustra taught his Magi priests were inscribed a celestial vault with the stars and planets discovered by the Babylonian star gazers. If Babylonian star wisdom only dates to the 5th century BC and the Egyptian Dendera zodiac dates to only 200 BC, why would the Mithras cult worship a symbol whose astrological origin dates to the age of Taurus in 4106 BC? Not very likely, in fact, any cultural nation which recognizes the "religious ages of mankind" must know prima facie of the phenomenon of the precession of the equinoxes. As I have said many times elsewhere, if the Greek astronomer Hipparchus really was the first to discover the precession cycle in the year 128 BC, then why did he call it the "great Platonic Year", when Plato was already 300 years dead?

In fact, the Babylonians inherited their star wisdom from the ancient Sumerian culture, who were the true star worshippers. Around the turn of this century, several professors (Pinches, Langdon and Jeremias) reconstructed from Sumerian tablets a complete Mesopotamian astrolabe. It was a disk of the great celestial circle within which were three concentric circles divided in sections of twelve units. Some 50 years later, Van der Waerden wrote a paper called BABYLONIAN ASTRONOMY: THE 36 STARS. The three concentric circles represent the three divisions of the modern celestial sphere, the northern, central and southern. The central band of 30 degrees above and below the equator which the Sumerians called the "way of Anu", represented the band of the constellations of our familiar zodiac. Along this band, the tablets list 26 major stars visible along the tropic of Cancer giving distances in three different measurements. One of these measurements is a distance in degrees of an arc from a division of the circle into 12 double hours of 30 degrees each, similar to our modern celestial sphere which measures the sidereal zodiac. Sumerian motifs of the bull and lion suggest symbols for the vernal equinox in Taurus and the summer solstice in Leo. Most artifacts show the beginning of their chronological vernal point to lie in Taurus, which we know to begin 4106 BC. One tablet in the Berlin museum begins their list of zodiac houses in Leo, which puts their chronological

record in the last astrological age of the Atlantean root race. One poem from their New Years rituals says " the constellation Lion that measured the waters of the deep." We know that the deluge of the Biblical flood occurred at the end of the astrological Lion age of Leo in the seventh and last cultural epoch of Atlantean civilization. The three concentric circles of 12 units each name 36 celestial bodies and give a series of numbers that add up to 360 degrees. Here was born the 36 decans. While the Egyptians may have invented astrology in Hellenistic Alexandria, there is no doubt that astronomy was invented in Sumerian temples many thousands of years prior to the Egyptian zodiac. The decans are 36 steps of the sun of 10 degrees each for a total of 360 degrees in the celestial great circle. Within each house, they are marked 1,2 and 3 so that the first decan in Aries is Aries-1, the second is Aries-2, etc. Thus, for each house, there is a front, middle and end. The Hermetic purpose of the subdivision of each zodiacal house into decans was to assign to each house three Planetary Rulers, the same planetary spirits of the second Angelic Hierarchy we saw above in the septenary assignment of Planetary Rulers to the 12 astrological ages of mankind. In the Chaldean order, they are again, Saturn, Jupiter, Mars, Sun, Venus, Mercury and Moon. Where ever the sequence of the decans begins, repeating the sequence five times results in $(7 \times 5 = 35)$ one decan being left over. Traditionally, the extra decan is assigned to the first decan of Aries, with Mars as the Ruler. See the attached plat for the sequence.

Thus, against the background of the solar sidereal great year of 25,920 years, there is FIRST, the influence of the 7 Planetary Rulers (Spirits of the Age) who rule the astrological ages of 2,160 years each and which predominate over the Decans. SECOND, there is the cooperative influence of the Planetary Rulers of the 36 decans, who rule within the astrological ages for 720 years each, in cooperation with the Archangelic Rulers (below). In Christian Esoterism, these subordinate rulers are called Archangels, leaders of nations, and they take orders from the Spirits of the Age from above and pass orders below to the hierarchy of Angels, who lead individual men. Both cycles are an example of the cooperative influences of spirits within the first Angelic Hierarchy who guide the spiritual evolution of humanity.

Arch-Angels of the Mystical Chronology

Now, there is a third subordinate cycle within the decans of the Archangels, which is difficult to reconcile as a septenary within the twelvefold zodiac. In 1508 there was written a "little book on mystical chronology mystical chronology" by a certain Johannes Trithemius (1462-1516), Abbott of Sponheim.

JOHANNES TRITHEMIUS

1462-1516

Abbot of Sponheim

A TREATISE ON THE SEVEN SECONDARY CAUSES, I.E.,
INTELLIGENCES, OR SPIRITS, WHO MOVE THE SPHERES
ACCORDING TO GOD

A Little Book or MYSTICAL CHRONOLOGY

Containing within a Short Compass Marvellous Secrets

Worthy of Interest

To the august and pious Maximilian I, Emperor & Caesar by the Grace of God:

Most wise Emperor, this lower world, created and organized by the First Intelligence, who is God, is ruled by Secondary Intelligences. Hermes, who gave us the science of the Magi, confirms this view when he says that seven Spirits were assigned to the seven Planets from the beginning of the heavens and of the earth.

Each of these Spirits rules the universe in turn for a period of 354 years and 4 months. Many learned scholars, up to the present day, have approved this assertion, which I do not guarantee, but only lay before your Most Blessed Majesty.

The first Angel or Spirit, that of Saturn, is called Orphiel God confided the government of the world to him starting with the beginning of creation. Orphiel's reign began on March 15 and lasts 354 years and 4 months. The name Orphiel was given to him on account of his spiritual office, not his nature. Under his rule, humans were crude and savage. Their customs recalled those of wild beasts of the wilderness. This requires no demonstration, for it is clearly evident from the Book of Genesis.

The second guiding Spirit of the world was Anael, the Spirit of Venus, who, following Orphiel, began to emit stellar influence in the year of the world 354, on June 24. Anael ruled the world for 354 years and 4 months until the year of creation 708, as calculation shows. Under Anael's rule, human beings began to be less crude. They built houses and cities, invented manual arts, and began the twin arts of the weaving and spinning of yarn. They also gave themselves up to the pleasures of the flesh and took wives. Forgetting God, they grew distant in many things from natural simplicity, invented games and songs, set themselves to playing the kithara and imagined all that had to do

with Venus and her cult. This life of debauchery ended only with the deluge that was the punishment for their depravity.

The third ruler, Zachariel, the Angel of Jupiter, began to rule the world in the year 708 after the creation of the heavens and the earth, in the eighth month that is, on October 26. Zachariel ruled the universe for 354 years and 4 months until the year 1060. Under Zachariel's direction humans began to take turns usurping power. They began to hunt, to put up tents, to decorate their bodies with different kinds of clothes. The good were separated from the evil the good invoked God, like Enoch who entered into Him, while the evil plunged into pleasures of the flesh. Under Zachariel, people began to live in society, to submit to laws imposed upon them by the strongest among them and, distancing themselves from their earlier barbarism, to civilize themselves. It was under Zachariel's rule that Adam, the first human being, died, leaving to posterity the inevitability of death. Lastly, in these days, several human inventions occurred, curious arts, as historians tell us.

The fourth ruler of the world was Raphael, the Spirit of Mercury, whose rule began on February 24 of the year 1063 following the creation of the earth and the heavens, and lasted 354 years and 4 months. The invention of writing goes back to this period. To begin with, letters were imagined in the forms of trees and plants, later taking on more careful forms to be modified at will. Under Raphael, the use of musical instruments spread; commerce and trading were practiced, as well as long-distance navigation, and many other marvelous things.

The fifth ruler of the world was Samael, the Angel of Mars, who began to reign on June 26, 1417.

Samael ruled for 354 years and 4 months and impressed his influence strongly upon humanity. Under Samael's reign, in the year of the world 1656, the universal flood occurred, as the Book of Genesis clearly shows. It is a remarkable fact, as the ancient philosophers tell us, that each time Samael, the Genius of Mars, governs the world, a complete change occurs in some great monarchy: religions and castes are overturned; great persons and princes are exiled; laws are changed as one can easily see in the historians. Such changes do not occur right at the beginning of Samael's reign, but only as it enters its second half. The same is true for all the other planetary Spirits, as history shows. That is, the influence of the secondary powers reaches its height when the stars reach the zenith of their revolution.

The sixth ruler of the world was Gabriel, Angel of the Moon. Gabriel began his reign after that of Samael, the Spirit of Mars, on October 28, 1771 years after the creation of the world. Gabriel's rule lasted 354 years and 4 months until the year 2126. During this period human beings multiplied further and founded many new cities. It must be noted, too, that, according to the Hebrews, the Flood occurred under the rule of Mars in the year of the world 1656. Isidore and Bede, two interpreters of the Septuagint, on the other hand, claim that this cataclysm occurred in the year 2242 that is, under the rule of Gabriel, Spirit of the Moon, which by calculation seems to me closer to the truth, though this is not the place to prove it.

The seventh ruler of the world was Michael, the Angel of the Sun, whose rule began, according to ordinary calculation, on February 24 in the year 2126 after the creation, and finished 354 years and 4 months later in the year 2480. Under the rule of this Angel of the Sun, according to those historians most worthy of belief, Kings first began to appear among mortals, and among these was Nimrod, the first to use sovereign power to tyrannize his fellows who were devoured by passions. Thus human folly instituted the cult of the Gods. Humans began to worship the lower principles as Gods. At this time, too, humanity invented various arts: Mathematics, Astronomy, Magic. The cult of a single God was practiced by different creatures but, due to human superstition, knowledge of the true God was gradually forgotten. At this time, likewise, agriculture began to be practiced and human beings began to have more civilized customs and institutions.

In eighth place, Oraphiel, the Angel of Saturn, returned and ruled the universe again for 354 years and 4 months- from June 26, 2480 until September, 2834. Under this Angel's rule, nations multiplied, the earth was divided into regions, and many kingdoms were founded. The Tower of Babel was built and "the confusion of tongues" occurred. Thus humanity dispersed over the earth and human beings began energetically to work the soil and cultivate fields, to sow wheat and plant vines, to prune fruit trees and busy themselves with all that concerned food and clothing. From this moment on, the distinction of nobility began to manifest and those who excelled by their virtue and genius received the insignia they deserved from their princes. At this time, too, humanity began to gain a sense of the universe as a whole, as, after the multiplication of races and the founding of many kingdoms, different languages came into being.

Then, in ninth place, the Spirit of Venus, Anael, began to rule the world once more. This was on October 29 in the year 2834 after the creation of the heavens and the earth. Anael ruled for 354 years and 4 months until the year of the world 3189. During this period, human beings, forgetting God, began to create a cult of the Dead. They began to worship the Dead and their statues in place of God.

This was an error that lasted more than two thousand years. Fashion introduced the use of precious ornaments for the body and, with the help of different sorts of musical instruments, humanity abandoned itself once again to the

passions and pleasures of the flesh, raising these up and even dedicating statues and temples to them. During this time Zoroaster, the first King of the Bactrians and other peoples, defeated in battle by Ninus, King of the Assyrians, discovered the mystery of incantations and curses.

In tenth place, Zachariel, the Angel of Jupiter, took up the direction of the world. This was on the last day of February in the year 3189 after the foundation of the heavens and the earth. Zachariel ruled for 354 years and 4 months, until the year 3543. This was a happy period, known with reason as the "Golden Age." The abundance of all the earth's goods led to the increase of the human species and the universe reached the height of its splendor. During this period, God gave Abraham the law of circumcision, promising for the first time the redemption of humanity by the incarnation of his only Son. Under Zachariel's rule, the Patriarchs, those founders of the spirit of justice, appeared. By their will and their works, the just were separated from the unjust. During this time, too, Jupiter, under the name of Lisanius, King and Son of Heaven and of God, was the first to give laws to the Arcadians, succeeding in civilizing them, building temples, instituting a priestly craft, and gaining many useful things for his people. This was why they gave him the name of Jupiter and, after his death, looked on him as a God. Yet he originated in the priestly caste of Heber, as history declares. It is also said that during this Angel's rule Prometheus, son of Atlantus, created humanity because, finding them coarse, he made them learned, human, good, and accomplished in manners and customs. He also invented the art of animating images. And it was he who first used the ring, the scepter, and the diadem, and invented royal insignia. At the same time, other sages of the race of Jupiter united men and women with the bonds of marriage, and brought humanity many other useful things. On account of their wisdom, after their death, these sages were raised into the ranks of the Gods. Of this kind were: Phoroneus, who was the first to give the Greeks laws and justice, Apollo, Minerva, Ceres, Serapis (among the Egyptians), and countless others.

In eleventh place, Raphael, the Spirit of Mercury, resumed the guidance of the world again on July 1, in the year of the world 3543, ruling 354 years and 4 months until the year 3897 from the creation of the world. [During this period, as ancient historians clearly show, humanity yielded with ardor to the study of wisdom. Among the most illustrious of these devotees of wisdom were: Mercurius, Bacchus, Omogyrus, Isis, Inachus, Argus, Apollo, Cecrops, and many others who, by their discoveries, were useful to the world and to posterity. During this time, too, various superstitions arose in humankind, such as the cult of idols, incantations, and the art of producing diabolical prodigies. Everything generally attributable to the subtlety and genius of Mercury took on vast proportions. Moses, the most wise leader of the Hebrews, the expert in many sciences and in all the arts, priest of the sole and true God, delivered his people from the slavery in which the Egyptians had kept them. At this same time, Janus the First ruled over Italy; Saturn, who taught the manuring of fields and was taken for a God, succeeded him. About this time, too, Cadmus invented the Greek letters and Carmetis, daughter of Evander, Latin letters. It was also in the reign of Raphael, Angel of Mercury, that the All-Powerful gave his people by the intermediary of Moses, the Law to which the Incarnation of CHRIST gave a dazzling testimony. A prodigious variety of cults manifested in the world. There were then numerous Sibyls, Prophets, Augurs, Haruspices, Magi, Diviners, not to mention the Sibyls of Erythraea, Delphi, and Phrygia.

In the twelfth epoch, Samael, Angel of Mars, became the world's ruler for a second time. This was on October 2 of the year of the world 3897. Samael ruled 354 years and 4 months until the year 4252. Under his reign, the great and celebrated destruction of Troy in Asia Minor occurred. Monarchies and many kingdoms fell and new ones were founded, such as Paris, Mainz, Carthage, Naples, and others. New kingdoms, too, arose, such as that of Lacedaemon, Corinth, Jerusalem, .

During this period, long wars and great struggles of Kings and nations unfolded, as well as dynastic changes. The Venetians, for example, trace the origin of their people and the founding of their city to this period of the taking of Troy. More remarkably still, several nations of Europe and Asia lay claim to Trojan descent-but in the desire to glorify themselves, as if there had not existed famous people and nations in Europe before the ruin of Troy, the proofs they offer in support of the nobility of their origin are vain and deceptive.

Under the dominion of this same planet, Mars, Saul, the First, was chosen King of the Jews. After him came David, then his son Solomon, who built to the true God a Temple in Jerusalem that was famous throughout the world. Then the Divine Spirit, illuminating its prophets with the incomparable clarity of grace, gave them not only the gift of predicting the future incarnation of the Savior, but also many other things, as the Holy Scriptures attest. Among these prophets, we may cite Nathan, son of King David, Gad, Azaph, Achaias, Semeias, Azarias, Anan, and many others. The Greek poet Homer, singer of the Fall of Troy, the Phrygian Dares and the Cretan Dictis who witnessed and told of it, are also said to have lived at this time.

For the thirteenth period, Gabriel, the genius of the Moon, resumed the rulership of the world on January 30 of the year 4252 from the world's beginning. Gabriel ruled 354 years and 4 months, until the year 4606. During this period several great prophets shone among the Hebrews: Elisha, Micah, Abdiah, and others. Among the Hebrews, likewise, Kings succeeded each other with rapidity. Lycurgus gave the Spartans a code and laws. Capitus, Liberius, Romulus,

and Procas Sylius, and Numitor-Italian Kings-flourished under this Spirit's reign. Under this same Lunar influence a number of other kingdoms arose, such as those of the Lydians, the Medes, the Macedonians, the Spartans, etc., while the Assyrian monarchy was ended by Sardanapalus. The Kingdom of Media also disappeared. At this time, many different kinds of laws were imposed upon humanity. Human beings neglected the worship of God. The cult of idols became widespread. In 4491, the 239th year of Gabrzel's reign, the foundations of Rome were laid. The dominion of the Sylians ended in Italy, their place being taken by the Romans. Around this time, too, the Seven Sages appeared in Greece: Thales, Solon, Cheilon, Periander, Cleobulus, Bias of Priene, and Pittacus. From this moment on, philosophers and poets began to be held in high esteem. Romulus, founder of Rome, fratricide, and abettor of sedition, ruled the city for 37 years. His successor, Numa Pompilius, ruled for 42 years, developing the cult of the Gods and dying in the time of Ezechias, King of the Jews. Toward the end of Gabriel's rule, Nebuchadnezzar, King of Babylon, captured and destroyed Jerusalem and led King Sedecias and his people into captivity. The prophet Jeremiah foretold both this destruction and the end of this captivity.

Following Gabriel, on May 1 of the year of the world 4606, Michael, the Spirit of the Sun, took up the world's scepter for the second time. Michael ruled the universe for 354 years and 4 months, until the year 4960 of the world's foundation. During his period, Merodach, King of Babylon, gave the Hebrew people their liberty and their King. This was under the influence of Michael, who, as the book of Daniel tells, protected the Jews whom God had given him. At this time, too, the Persian monarchy arose whose first Kings, Darius and Cyrus, overturned the great Babylonian monarchy. This was in the reign of Balthasar, as Daniel and the prophets predicted. The Cumaean Sibyl was also famous then, because of the offer she made to King Tarquin the Elder to sell him at once, and at the same price, the nine books containing the series of predictions having to do with the Roman Republic. When the King refused to pay the price that was asked, the Sybil burnt the first three books before his eyes, and then demanded the same sum for the remaining six. Refused again, she threw three more books into the fire, and would have done the same for the last three, had not the King, persuaded by his Counsellors, saved these books from destruction by agreeing to pay the price asked in the beginning for the set of nine. These same Romans, after the expulsion of their Kings, designated two Consuls annually. This was the period when Phalaris, the tyrant, ruled in Sicily. Magic was held in great esteem at this time among the Kings of Persia. Pythagoras and other philosophers flourished in Greece. The city of Jerusalem and its Temple were reconstructed. The prophet Esdras restored from memory the Books of Moses, which had been burnt by the Chaldeans. This new text was called the Babylonian version. Xerxes, King of Persia, led an army against the Greeks, but without great effect. The Gauls captured, burned, and destroyed Rome, except for the Capitol which was saved by a goose who awoke the sleeping soldiers with his honking. The Athenians were then engaged in their famous wars and the philosophers Socrates and Plato gained their renown. Following the repeal of the Consuls, the Romans instituted the offices of the Tribunes and the Aediles. Meanwhile, a host of calamities assailed them.

Immediately following the end of Michael's dominion, Alexander the Great ruled in Macedonia; he overcame the Persian monarchy under Darius, and brought all Asia under his scepter, as well as a part of Europe. He died at the age of 33, after a reign of 12 years and 5 months. Many wars and ills followed his death and his empire was dismembered into four parts. Among the Hebrews, competitions were held for the High Priesthood for the first time. And the Kingdom of Syria was born.

After Michael, Orphiel, the Spirit of Saturn, took up the government of the world for the third time (and the fifteenth period) on the last day of September in the year 4960 from the beginning of the world. He ruled for 354 years and 4 months, until the year 5315. Under his rule, the Punic Wars began between the Romans and the Carthaginians. The city of Rome was almost completely destroyed by fire and water. The Colossus, a bronze sculpture, 126 feet high, was toppled by an earthquake. After the Punic War, Rome, which had warred unceasingly for 440 years, enjoyed a year of peace. Jerusalem and its Temple were burnt and destroyed by Antiochus and Epiphanes. The Maccabees became famous for glorious battles. During this period, too, 606 years after the founding of Rome, Carthage was destroyed and burned for seventeen days. In Sicily, the revolt of the 70,000 slaves against their masters occurred. Great wonders took place at this time in Europe. Domestic animals fled into the woods, blood flowed, and an exploding ball of fire fell from the sky with a great din. Mithridates, King of Pontus and Armenia, waged a war against Rome for 40 years. The Kingdom of the Hebrews was restored, after a hiatus lasting 575 years from Zedechias to Aristobulus. The Germans and the Teutons invaded Italy and were defeated after many battles, losing 160,000 men, not counting the considerable number of those who perished with their families under Caius and Manlius, after having treacherously killed many Romans. Finally, 40 years of civil war desolated Italy. Three suns appeared in Rome, melting, after a short time, into one. A few years later, Julius Caesar usurped the supreme power, and following him Augustus extended his power into Asia and Africa, uniting these under a single rule. Augustus ruled for 36 years, during which God gave the world peace.

In the year of the world 5199, the 751st year of Rome's foundation, the 42nd year of Octavius Caesar Augustus, 245 years into the reign of Oriphiel, the Spirit of Saturn, the eighth month, on December 25, Jesus Christ, the Son of God, was born of the Virgin Mary, in Bethlehem, in Judea. Note that by the admirable ordering of divine Providence, the universe was created in the first rulership of Oriphiel or Saturn and was saved, restored, and renewed by his mercy during his third administration a harmonious agreement which sufficiently proves the influence of the seven planets on the government of the universe. Indeed, during Oriphiel's first rulership, the whole world formed but a single, vast monarchy, which, during his second rulership, subdivided into a multitude of little kingdoms as we have shown above which themselves were brought into unity once again under his third rulership. This notwithstanding, it is clear to those with clairvoyant eyes that the second period of Oriphiel also saw a single monarchy with the building of the Tower of Babel. During this third reign of Oriphiel the Kingdom of the deus was scattered and the perpetual sacrifice of victims was suspended. And freedom will not be given to the Jews again until the third period of Michael in August 1880 of the Christian Era, which is the year of the world 7170. In the year 299 of the Angel Oriphiel's rulership, Peter transferred the great Office of the Pontiff of the Universal Christian Church from Judea to Rome. Many Jews and Gentiles embraced the Christian religion on account of the preaching of sermons of great simplicity and un-sophistication, illuminated not by human knowledge but by the Spirit of God. The world at this moment returned to the innocence and simplicity of the first age. In both, Oriphiel, Spirit of Saturn, presided. The heavens were united with the earth. Two scepters were given to humanity to rule the world: a higher one, for spiritual things, was given to the Pope; another, for temporal things, was given to the Emperor. Many Christians, persecuted by the princes of this world, perished for their faith. Toward the end of Oriphiel's reign, the Romans destroyed Jerusalem, and the Jews were scattered over all the earth: 110,000 were killed; 80,000 were sold; and the rest fled. In this way, Rome completely destroyed Judea.

In sixteenth place, after Oriphiel, Anael, Spirit of Venus, took up the direction of the universe for the third time on the last day of January, 5315 years from the foundation of the heavens and the earth, 109 years after Christ's Nativity to rule for 354 years and 4 months to the year of the world 5669 and 4 months, which is the year 463 of the Lord's incarnation. We may note that, during almost this entire reign of the Angel of Venus, the Christian Church increased amidst persecutions, and finally prevailed after thousands were murdered for their faith in Christ. Numerous heresies then arose in the bosom of the Church heresies that were extinguished from the blood of the virtuous only with great trouble and after much time. At that time, too, numerous people arose who were celebrated in all branches of knowledge: theologians, astronomers, doctors, orators, historians not only among the gentiles but also among Christians. The faithless finally stopped persecuting the Church after Constantine the Great was baptized in the year of the world 5539 when the Angel of Venus, Anael had passed the culminating point of its cycle of dominion. After this there were still some troubles caused by impious people, but the Church generally lived in peace. During this period, the human race which, since the time of King Ninus had been miserably lost in the cult of idols for 2,300 years, was mercifully brought back to knowledge of the one God. Many subtle arts grew up and, in agreement with the nature of Venus, developed and embellished themselves. For human manners change with the times and things below correspond with things above, and receive their influence. The soul, besides, is free, and not under the influence of the stars, unless it becomes stained, being too attached to the body, and allows itself to be guided by the latter. For the Angels, engines of the orbs, can neither destroy nor alter anything established by nature. A huge comet announced the death of Constantine. The Arian heresy troubled the Holy Church in many places. Toward the end of Anael's rule, in the time of the Emperor Julian, crosses appeared on the linen robes of certain persons. In Asia and Palestine, wars, plagues, and famines followed the apparitions in which these crosses were seen. In these days, too, around the year 360 of the Christian Era, the Franks came out of Germany and invaded, occupied, and conquered Gaul, to which they gave their name. France was great and large, and its capital was Mainz (Herbipolis). Bavarians, Swabians, Saxons, Thuringians, the inhabitants of the Rhine, and the tribes surrounding the Papal Kingdom occupied the greater part of what was then France and which today includes Germany. 280 years into this reign of Anael, the Roman Empire began its decline. Its capital, Rome, was captured and burned by the Goths. This was after Constantine had moved the seat of the Empire to Byzantium, a fatal deed that caused the decadence of the entire monarchy. Indeed, toward the end of Anael's rule, there appeared, as historians tell, Radagif, Alaric, and Athaulfe, Kings of the Goths, who were soon followed by Genseric, King of the Vandals, and Attila, King of the Huns all of whom invaded the whole of Europe and cut the Empire into pieces.

Following Anael, and in seventeenth place, Zachariel, Spirit of Jupiter, took up the direction of the world for the third time on June 1 of the year of the world 5669, which is the year 463 after the Birth of the Savior. He ruled for 354 years and 4 months, to the year of the world 6023, which is the year of the Savior 817. During these days, many people gave themselves passionately to the study of Christian philosophy. Many wonders occurred: comets, earthquakes, rainfalls of blood.

Merlin, who was born in Caledonia at the beginning of Zachariel's rule, made astonishing predictions. Arcturus, commonly called Arthur, most famous King of Britain, overcame the barbarians, brought peace to the Church, triumphed in many battles, spread abroad the Christian faith, and brought all of Gaul, Norway, Dacia, as well as several provinces, under his rule. Arthur was the most glorious prince of his time; after accomplishing many high deeds, he suddenly disappeared, and for many years the Britons awaited his return. Many poets sang of his prodigious exploits; under his rule, England flourished and commanded three times ten kingdoms.

In these days, the monastic Orders began to multiply in God's Church. Theodoric, King of the Arian Goths, conquered Italy. The Empire and the Church were in trouble. Zeno and Anastasius, the Emperor of the East, Theodoric and his successors in Italy, Honorius, King of the Vandals in Africa—all these exercised an unequalled tyranny. Clovis, King of the Franks of Gaul, was baptized, overcame the Goths, and imposed peace, though not in the whole world. This was in the time of St. Benedict, around the year 500 of the Christian Era, toward the opening of the reign of Zachariel, the Angel of Jupiter; whose influence led to changes of dynasties and kingdoms, as the historians repeatedly affirm. What this Angel cannot do himself, he leaves to his successor Raphael, Angel of Mercury, who put Charlemagne on the throne of France. Indeed, during Zachariel's 350 years many empires crumbled, including those of the Goths, the Vandals, the Burgundians, the Lombards, the Thuringians, the Germans, the Bavarians, and many others. The Emperor Justinian was the first to give the Republic a coherent set of laws. Several eminent people gained renown under Zachariel. Justinian built the basilica of Sancta Sophia in Constantinople. The Empire, divided, was in trouble and confusion. Many omens appeared, as history tells. Kusro, King of the Persians, took Jerusalem. Later, he was assassinated by Heracles. At this time, around the year 600 of the Christian Era, the Arab Mohammed founded the sect of the Saracens. This would soon completely supplant the Roman Empire in Asia. Dagobert, King of France, conquered and destroyed the English, then called the "Saxons." It must be noted that soon afterward the Christian faith began to weaken in Asia and Africa, while the sect of the Saracens gradually penetrated everywhere, soon covering the whole world, with the exception of Europe, where the Order of St. Benedict spread the Christian religion. Toward the year of our Lord 774, crosses appeared on some people's clothing and, a little later, the Roman Empire was divided, one part passing into Frankish hands under Charlemagne. This prince restored the Church and fought many wars. After his victories, the name "Western Gaul" was given to the Saxon territory.

In eighteenth place, following Zachariel (the Angel of Jupiter) Raphael (the Spirit of Mercury) assumed the government of the world for the third time on November 2, 6023 years after the world's foundation, which is the year 817 of the Savior's birth. Raphael ruled the universe for 354 years and 4 months, until the year of the world 6378, which is the year of our Lord 1171. At the beginning of this period of Mercury, as we have said, the Roman Empire passed into the hands of Charlemagne. After him, his son Louis reigned for 25 years; after his death his sons fought against each other, thus weakening the Empire yet again. The Normans devastated Gaul. Twice, Rome was sacked by the Saracens. It rained blood for three days under Louis II. In Saxony, a whole town, with all its buildings and inhabitants, was swallowed up in a terrible abyss opened up by an earthquake. Toward the year of our Lord 910 great troubles arose in Italy, which left the Frankish Empire and chose its own Kings. The first was Berenger, Prince of Friuli, who was followed by seven Kings in a space of about fifty years when the Empire passed to the Germans. The first Emperor was Otto I, who undertook to reconstruct the monarchy.

Otto II, his son, and Otto III, his nephew, the successors on the imperial throne, converted the Hungarian people to the Christian faith. In the year 1000 of the Christian Era, Otto III, who died with out progeny, established the Electors of the Empire, as has been conserved even to our own days. The Saracens took Jerusalem again.

Many omens were seen in the sky, the air, on the earth, the sea, and in the waters. Following the death of Otto III, Henry I was elected by the princes to succeed him. Henry I reigned 20 years and founded the Church of Bamberg. At the same time, Kunegund, his wife, died a virgin, famous for her miracles. After Henry, Konrad I was elected Emperor. He reigned 20 years. At this time also Godefroy, Count of Bouillon, dispersed the infidels from Jerusalem and the Holy Land. Before the end of Raphael's rule, many omens and numerous signs were seen; and, a little later, the Tartar race left its frontiers and inflicted great evils on the Roman Empire. Famines, plagues, earthquakes, and other calamities befell the Empire. In the year of our Lord 1153, Frederick I, called Barbarossa, assumed the scepter. He reigned for 33 years beginning in the 336th year of Raphael's rulership and accomplished many admirable things. He increased the power of his Empire and successfully undertook many wars. Under his reign, the Egians and the Lithunians embraced Christianity.

In nineteenth place, Samael, the Angel of Mars, took up for the third time the governance of the world on March 3 of the year of the world 6378. He ruled 354 years and 4 months, until the year of the world 6732, or the year of the Lord 1525. Under his rulership there were many wars in the world; thousands of people perished, and several kingdoms lost their borders. The Emperor Frederick I had many differences with the Princes of Italy; he waged great

wars against them in which they perished in the thousands. He ravaged Milan from top to bottom. Liege was destroyed. Jerusalem was taken again by the Saracens.

The Empire of the Tartars grew greatly on the face of the earth. This was a true calamity for the world-and continues still today. After Frederick, his son Henry was elected Emperor. And on Henry's death a schism between Philip and Otto divided the Empire, causing great troubles. Many battles were fought on the German borders at Argentine, Cologne, Leiden, Spire in Wurtemberg and throughout the kingdom. The Order of Mendicants was founded during this epoch, in the fortieth year or so of Samael, which shows that all things are providential. In Asia and Africa, the Saracens fought the Christians in numerous places. Constantinople was taken by the Germans, and Baudoin, Count of Flanders, was raised to imperial dignity. More than 20,000 German children, seduced by lying speeches into trying to reconquer the Holy Land, were carried off by pirates on the open sea. A group of shepherds from Spain approached Paris, seizing the property of the clergy, much to the delight of the people but when they sought to seize the possessions of lay people, they were massacred. In 1212 (of the Christian Era), Frederick II was elected Emperor; he reigned 33 years and did many things against the Church. In 1238, there was an eclipse and continuous earthquakes destroyed thousands of people. Frisia was almost completely submerged and more than 100,000 people drowned. The Tartars devastated Hungary and Poland, and conquered Armenia and several other countries. In the year 1244 of the Christian Era, a Jew, digging in the ground near Toledo, found a book in which it was written that Christ would be born of the Virgin Mary in the third world and would suffer for the salvation of humanity; he converted immediately and was baptized. The third world, i.e., the third period of the Spirit of Saturn, was, as we have shown, when Christ was born of a Virgin. During this period of Samael, the Roman pontiffs, deposing the Emperor Frederick, left the imperial throne empty for 28 years until the election of Rudolf, Count of Hamburg, who was chosen in favor of the other princely candidates: Henry, Count of Schwarzenburg in Thuringia; William, Count of Holland; Konrad, Frederick's son; Alphonzo, King of Castile; and Richard, Count of Cornwall, brother of the King of England. Ills multiplied upon the earth. Then, around the year of our Savior 1260, the Swiss Confederation was born, a small country that was to grow with time. Because its people were warlike, it attacked other nations and thus extended its borders. This made all Germany know of the existence of this new republic. Then, in the year 1273 of the Christian Era, the Assembly of Imperial Princes elected Rudolf of Hapsburg. He ruled for 18 years, prudent and wise in many things. All the Dukes of Austria descend from him. The Tartars invaded the Christian lands, seizing Constantinople and Greece, and causing much damage. The Saracens took several cities in Asia, killing more than 400 Christians. Upon the death of Rudolf, Adolf of Nassau was elected Emperor and ruled for 6 years. Albert, Rudolf's son, defeated him at Worms and, after killing him, was elected in his place in 1298. After ruling 10 years, he was himself killed by his brother's son. The Order of the Templars was destroyed on the orders of Pope Clement V. The island of Rhodes was taken by the Saracens following an uninterrupted siege lasting 4 years. After the assassination of Albert by his nephew, Henry VIII, Count of Luxemburg, was named Emperor and ruled 5 years. After him, Louis IV of Bavaria was Emperor for 32 years, beginning in 1315. The Roman Cardinals gave him the crown. Frederick, Duke of Austria, opposed them, but he was defeated. Then Charles IV, King of Bohemia, was Emperor for 31 years. He raised the Bishopric of Prague to an Archbishopric. There were great earthquakes. In 1453, Constantinople was taken by the Turks on account of the treachery of a certain Janvans. Soon the whole of Greece abandoned Christianity. For, in a short time, several Christian principalities and kingdoms were taken and ravaged by the Turks. In these days, many serious wars broke out among the Christians in Gaul, in England, in Saxony, in Westphalia, in Prussia, in Flanders, in Sweden, as well as in other countries. At this time, too, the art of printing, which was an admirable discovery, a divine gift, occurred at Mainz, the capital of Germany. In the year 1456 of the Christian Era, the Turks, massacred in Hungary by the faithful, perished in great numbers. An admirable pilgrimage of children came to Saint Michel. There were earthquakes in the Kingdom of Naples which caused more than 40,000 people to perish....

In the year 1486 of the Christian Era, Maximilian, son of Frederick, was consecrated King of the Romans in Frankfurt and hailed as Holy Roman Emperor by Pope Julius II in 1508. He founded the military order of St. George against the heretics and the Turks. He vanquished the Swiss, reduced the Sicambrians, and triumphed over all rebels. The King of France, pursuing the imperial Crown according to his custom, hatched plots against the Empire; but the All-Powerful maintained what had been organized by Samael. In 1508, the Venetians, revolting against the authority of the Emperor, were punished by banishment and death. Stubbornness will be punished, wise submission rewarded. Toward the end of this third period of Samael, an important change, returning things to their original, first state, will lead to the destruction of many worlds. In fact, if by the will of God, the "gamma point" is brought to face the North, a great change will occur in some monarchy or great kingdom. A great religious sect will rise up to replace the ancient cults.

It is to be feared that the fourth beast of the Apocalypse could lose a head. During the first period of Samael, Mars announced the flood; during the second, the fall of Troy; toward the end of the third, there will be a break in unity.

Indeed, based upon the precedents, one might infer the following: This third period of Mars will not conclude without this prophecy being fulfilled and a new religion being instituted. Now, only 17 years remain between the present year of the Christian Era (1508) and the end of Samael's reign in 1525. Omens of ill fortune will be seen. For, before the year 1525 of the Christian Era, the crosses seen these last 10 years on people's clothes will have their consequences....

For the twentieth period, Gabriel, Angel of the Moon, will take up the direction of the world again on June 4 of the year of creation 6732, which is the year 15252 of the Christian Era. Gabriel will govern the world for 354 years and 4 months until the year of the world 7086, the eighth month, or the year of the Lord 1879. It would require a prophecy for the series of future events. I do not guarantee the things I have written, most wise Caesar, but one can reasonably believe in them without damage to one's faith. There are some who believe that these periods correspond to lunar months; if such is your opinion, I could agree, but then it would be necessary to change what I have written. For the rest, I bear witness with my hand and confess with my mouth that in all things I believe and admit only what the Catholic Church has approved by the authority of its Doctors; all else I thrust aside as vain and superstitious fiction.

(The following correspondences can be drawn from the foregoing given the translation into our calendar)

1. 1879 to 1510 Gabriel- Moon (369 yrs)
2. 1510 to 1190 Samuel- Mars (320 yrs)
3. 1190 to 850 Raphael- Mercury (340 yrs)
4. 850 to 500 Zachariel- Jupiter (350 yrs)
5. 500 to 150 Anael- Venus (350 yrs)
6. 150 to 200 BC Oriphiel- Saturn (350 yrs)

Total= 2079 yrs for the cycle

His sources had been a similar manuscript written by Peter of Abano (1215-1313) who was a learned scholar and translator of the Kabbalistic and astrological books of Rabbi ibn Ezra. According to the researches of Christopher Bamford, the first English translation of the little book was by the English magician, William Lilly. Later it surfaces in the occult writings of the Frenchman, Eliphas Levi (1855) and passed on by him to Anna B. Kingsford and Edward Maitland, two more English, but Christian occultists. From Maitland, the book passed on the W. Wynn Wescott, all of whom were members of the T.S. and close friends of the good Madame H.P.B. Indeed, there is a small footnote to Trithemius in volume I of the SECRET DOCTRINE, although not another word of it is mentioned. Wescott published it in 1896, presumably as a magic ritual for the members of the Golden Dawn.

The Mystical Chronology is a wonderful little book full of esoteric Christian gems of wisdom. It begins, "Most wise Emperor, this lower world, created and organized by the First Intelligence, who is god, is ruled by Secondary Intelligences. Hermes, who gave us the science of the Magi (our ancient Chaldean/Sumerian star gazers), confirms this when he says that seven spirits were assigned to the seven planets from the beginning of the heavens and of the earth.

"Each of these Spirits rules the universe in turn for a period of 354 years and 4 months...The first angel or spirit, that of Saturn, is called Oriphiel. God confided the government of the world to him starting with the beginning of creation."

The chronological order is difficult to cipher, since he begins in the first year of the world (book of Genesis), and counts forward in time, so that the first cycle seven rounds is completed on June 26, 2480 and the second cycle of seven rounds is completed on September 1, 4960. Transposing these cycles to our Julian calendar, we have the third cycle of:

Oriphiel, from -----245BC to 109BC;
Anael, from -----109BC to 463 AD;
Zachariel, from -----463 to 817;
Raphael, from -----817 to 1171;
Samael, from -----1171 to 1525;
Gabriel, from -----1525 to 1879; and
Michael, the sun spirit beginning 1879.

This is obviously a septenary of Archangelic rule of 354.3 years each, but the cycles do not divide by seven evenly into an astrological age of 2160 years (308.57 years). The cipher makes more sense if a Decan cycle of one-sixth per age of 360 (instead of 720 years) years each is used and then take three Decan cycles of 600 years each (instead of

720 years) and add to it an archangelic cycle of 360 years. Then, this cipher results in our astrological age cycle of 2160 years.

Although troublesome to cipher exactly, the times of the cycle are both accurate and relied upon. Accurate because Dr. Steiner had spoken hundreds of times about the "Battle in Heaven" in the years between 1841 and 1879, wherein the Spirits of Darkness belonging to Ahriman fought the good spirits of Archangel Michael (pronounced, Mic-ha-el), prior to his regency beginning year 1879. Relied upon, because Dr. Steiner devoted and dedicated his whole life's work to the regency of Michael.

DIFFERENCES between the Two Zodiacs

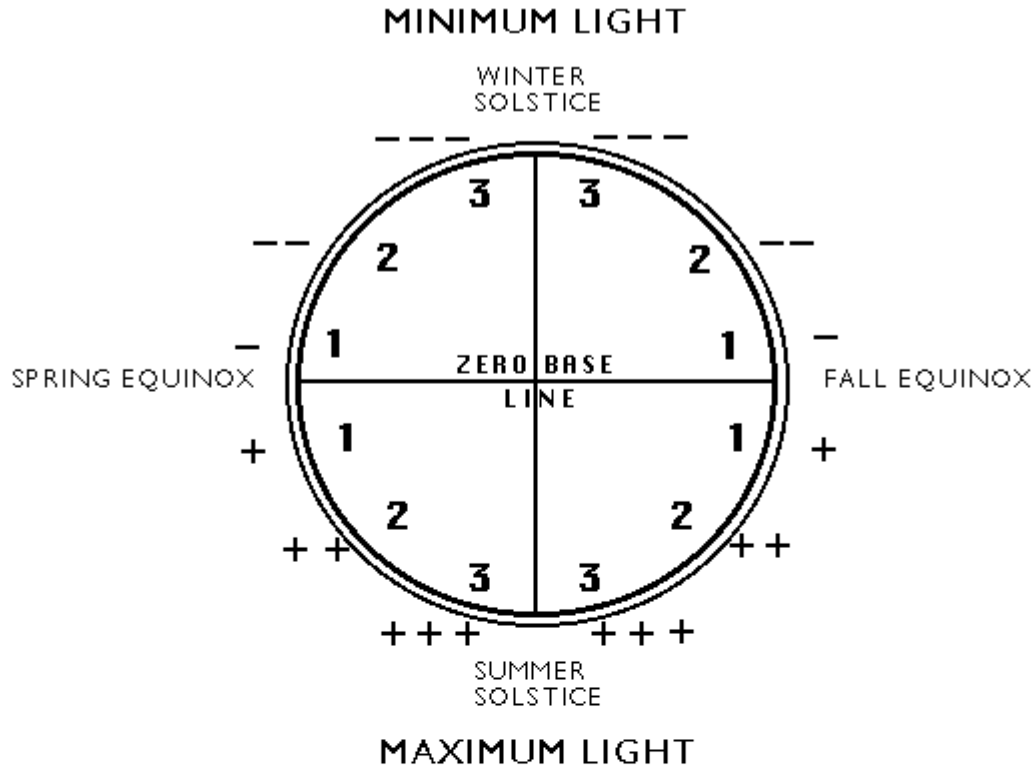

SIDEREAL ZODIAC	US	TROPICAL ZODIAC
1. 36 steps of the Decans		1. 12 steps in declination
2. Solar calendar		2. Lunar calendar
3. Cosmic time (1°=72 years)		3. Human time (360°=1 yr.)
4. Clockwise motion in celestial longitude		4. Counter-clockwise motion in latitude
5. 1 great solar year		5. 25,920 human years
6. 72 earth breaths		6. 1 earth breath
7. cycle of 12 human incarnations (from celestial sidereal archtypes)		7. Cycle of light/nature

Although each zodiac is important for its intended purpose, there are very important differences between them. Traditional symbolism relating to the zodiacal archtypes is often confusing and misleading because, historically, no

distinction is made between them for mere lack of specificity not to mention the deliberate Blinds that used to fascinate the good Madame H.P.B. and other occultists. We will endeavor to specifically assign to each zodiac its corresponding symbolism as appropriate.

First, the tropical zodiac is a zodiac of increasing and decreasing light which works upon the plant kingdom as light as warmth. The starting point for this yearly cycle begins on March 21st at the spring equinox at which time the hours of daylight begin to last longer than the hours of darkness. This zero base line is shown in the attached plat. The first 3 steps of the sun in declination beginning the vernal equinox is a cycle of increasing light until the maximum is reached at summer solstice. The next 3 steps of the sun, from the summer solstice to the fall equinox, is a cycle of decreasing light, but the light still predominates over the darkness. Beginning the fall equinox, the scales are tipped in favor of the cycle of darkness. The next 3 steps of the sun, from the fall equinox to the winter solstice, is a cycle of increasing darkness. At the winter solstice, there is a minimum of sunlight and a maximum of darkness. The next 3 steps of the sun, from the winter solstice to the vernal equinox, is a cycle of decreasing darkness, but darkness predominates over sunlight.

Thus, the annual cycle of light/darkness corresponds exactly to the motion of the sun thru the tropical zodiac in declination. For this reason, we have the annual cycles of growth-in spring; expansion-in summer; decay-in-fall and contraction-in winter. In fact, this yearly cycle is like one large breath in the life of the earth, one of inhalation and exhalation.

All ancient cultures began their New Year in exact correspondence with this date of the beginning of spring. For our Sumerian/Chaldean/Babylonian star gazers, the first lunar month began on the new moon falling after the vernal equinox. This great festival celebration, which has been carried over on a different date to our Christian Easter, was called the NEOMENIA, commencing the 1st day of Aries. With the fixing of the first day of spring on March 21st-the 1st of Aries by the acceptance of the Julian calendar, we have forgotten that the actual Neomenia varies over a cycle of nineteen years. However, with the celebration of Easter as a movable feast, we are reminded somewhat that the first day of spring is a cosmic event, not determined by man, but by the cycle of the earth's annual breath. Because of the importance of the Neomenia in determining the first day of spring, all ancients used a lunar calendar recognizing the correspondence between the moon phases and plant growth. A typical lunar calendar consisted of 354 (1/3) days composed of 12 lunar (synodic) months each 29 1/2 days long. Long before the Julian calendar was adopted in 45 BC, the priests of each culture did know the length of the solar astronomical year at 365 days, a difference of about eleven days from the lunar year. Because the lunar year elapsed eleven days before the solar year, an intercalation was inserted to balance out the year. Usually this was accomplished by the insertion of a thirteenth month every three years. The exact method known to our Chaldean/Babylonian Magi was based upon the 19 year cycle historically attributed to Meton in 433 BC.

Lunar phases recur on the same day of the month over a cycle of nearly 19 years, now called the Metonic cycle. There are 235 synodic (29.5 days) months in every 19 Julian calendar years. Beginning about the 6th century BC, the Chaldeans inserted this extra lunar month in an intercalary year as a second month of Virgo before the fall equinox or as a second month of Pisces prior to the vernal equinox.

Prior to the adoption of the Julian calendar, it is believed that the Essenes at Qumran were the only ancient cult to actually use a solar astronomical calendar year consisting of 12 months of 52 weeks of 7 days each. These 364 days were divided into four quarters of 91 days each, like the 4 X 91 steps on the Mayan Chichen Itza pyramid. Although each lunar season consisted of three months of thirty days each, the extra 31st day was added four times per year at the end of the month of each quarter. Obviously, in the Jewish tradition when the Essenes were using a solar calendar different from the Pharisees, problems over the dates of certain festivals could occur.

In fact, when Jesus was brought before Caiaphas to answer to sedition charges, one serious charge was that Jesus ate the Pascal lamb on the day before Passover. Sister Emmerich relates that as a response to the charge, "Nicodemus and Joseph of Arimathea proved from written documents that the Galileans, according to our ancient custom, were permitted to eat Pasch one day earlier than the other Jews." She also stated that "The Galileans did not always make use of their privilege." That Nicodemus used written documents implies to me that these documents may have been the solar calendar tables of the Essenes, which might vary the celebration dates of traditional festivals in certain years when the Pharisees used intercalation days to balance their lunar year.

In conclusion, the differences (chart) between the tropical and sidereal zodiacs are significant. Whereas the tropical zodiac has 12 steps of the sun, the sidereal zodiac has 36 steps over the course of 25,920 years. The motion of the sun thru the tropical zodiac is counter-clockwise in celestial latitude. The motion of the sun thru the sidereal zodiac is clock-wise in celestial longitude.

In addition, there is the difference of eleven days between the solar and lunar calendar years. In the human time of the tropical zodiac, one year equals 365 1/4 days, whereas, in the cosmic time of the sidereal zodiac, one day of

earth time is 1 degree of precession over 72 human years. One human day equals 25, 920 individual human breaths, whereas, one breath of the earth, as the cycle of light/darkness equals one human year. These are the differences we will try to explore in the traditional symbolism of the zodiac, by specifically assigning to the appropriate zodiac its intended ciphers.

SYMBOLS OF THE TROPICAL ZODIAC

The Amahraspands

The holy book of the Zoroastrians is the AVESTA, which like the Hindu VEDAS, codifies the much earlier oral teachings that existed for thousands of years before the book. The Persian cultural epoch lasted from 5076 BC to 2907 BC and Zarathustra was the prophet appointed by the solar deity. The general schema of Mazdean cosmology reflects the tropical zodiac structure of the phases of the declination of light. The Persian wisdom was very simplistic and separated the universe into two halves, one of light, represented in the tropical zodiac as the passage from the vernal equinox thru the summer solstice to the autumnal equinox, and one of darkness, represented in the tropical zodiac as the passage from the autumnal equinox thru the winter solstice to the vernal equinox.

The Avestan Ahura Mazda, later in the 9th century texts, Ohrmazd, was the appointed "Lord of Wisdom" and he ruled the height of the heavens of light. His appointed antagonist was the Avestan, Angra Mainyu, later called Ahriman. Ahriman ruled the depth of the abyss of darkness and was the counter-power of the power of light. He was responsible for evil, disease, disintegration and death. It is for this reason that Dr. Steiner calls Ahura Mazda the second revelation of the Christ, the first revelation of the 7 Rishis being the Hindu Vishnu and the third revelation of the Egyptians being called Osiris. Karman Ahriman, he calls the spirit of the earth whose elementary spirits are the forces of the laws of nature.

Between these two eternal powers of light and darkness, good and evil, was the earth as battleground, together with all creation. Evil was a substance created by god, but placed into the creation to separate matter, so that it may run its course of the seven-fold cycles of infinite diversity of manifestation. At the end of the cycle of manifestation, the aeon will come to restore the mix and cast Ahriman and his demons back into the abyss. This is the source of the theological dualism long attributed to Mazdaism and later to Manicheism by our professors of dogma, who reduce this revelation to childish and rudimentary cosmology.

Surrounding the Lord of Wisdom and Light were six emanations called AMAHRASPANDS, the Avestan Amerta Spenta, belonging to the hierarchy of archangels. Together with Ohrmazd, these six archangels form a Divine Heptad, of which three were masculine on his right side and three were feminine, on his left side. To the masculine side were assigned the tasks: VOHO MANAH, the protection of the entire animal creation; ARTA VAHISHTA, the element of fire in all its manifestations; and to XSHATHRA VAIRYA, the delegation of the metals.

To the feminine side were assigned the tasks: SPENTA ARMAITI, the divine wisdom (our Sophia); HAARVATAT, the element of water and its kingdom of creations; and to AMERTAT, the entire plant and vegetable kingdoms. These were so many emanations from the good principle as blessings bestowed upon mankind in which to cooperate for the element or kingdom assigned.

Ahriman, in his turn, also emanated six DEVS, as eternal opponents of the six good emanations. Again, this shows the Mazdean concept of evil as a roadblock across the path of normal evolution, a celestial plan of opposition, so as to manifest the infinite possibilities of existence on our physical plane. Helping assist the Divine Plan of the Powers of Light, are so many YAZATAS, or Izads in Persian, which belong to the hierarchy of angels, whose legion is infinite. Finally, there is the legion of FRAVARTIS, called "those who have chosen", who were feminine angels who also assist the Divine Plan but are also heavenly archetypes of all the ranks of angels, including Ohrmazd himself.

The ancient wisdom of the tropical zodiac symbolized the six Amahraspands under the banners of light and the six Devs under the banners of darkness. This, of course, corresponds to the six months of positive declination and six months of negative declination. In Mazdean chronology, cyclical time was measured by the passage of the sun thru the tropical zodiac in a great year of 12,000 human years and of 12 parts, one for each zodiacal house. During the great cycle, the tropical zodiac was divided between the two powers, for 3 thousand years, good triumphed, then for 3 thousand years, evil held sway. Then for the remaining 6 thousand years, they mutually destroy each other's labors. At the end of the 12 millennia, a virgin enters the waters of lake Kansaoya, where she is miraculously impregnated and gives virgin birth to the Aeon sent to redeem mankind. Sound familiar ?

The Essene Belial

The saga of the Lords of Light doing battle against the Lords of Darkness does not end with the fall of the Persian cultural epoch. This eschatological text is resurrected in the Dead Sea scrolls written by the Essenes of Qumran. This brotherhood renamed the Persian Ahriman as Belial, the leader of the spirits of darkness. We discussed (infra)

that St. Paul learned his esoteric angelology from the Essenes and brought this secret wisdom to Athens where he initiated Dionysius the Aeropagite. In II Corinthians 6:15 Paul asks, "What concord hath Christ with Belial?", clearly equating Belial with Satan, the leader of all demons.

The Essenes called themselves the "Sons of Light" who opposed the "Sons of Darkness." In the WAR SCROLL they describe another cosmic battle between good and evil. In it they also resurrect the 4 cycles of 3 thousand years war described in the Avesta.

" The Sons of Light and the lot of Darkness (the army of Belial) shall battle together for God's might. In the war, the Sons of Light shall be the strongest during three lots, in order to strike down wickedness, and in three lots, the army of Belial will gird themselves in order to force the lot (of the sons of Levi, Judah and Benjamin) to retreat."

The Sons of Light do eternal battle against the forces of Belial, which include both traditional Hebrew enemies called the Kittim, probably the Roman empire, and their own brethren, who belong to the "congregation of Belial." Sister Emmerich clearly identified this congregation as the Pharisees, the Sadducees and the Herodians, all of whom were enemies of the new covenant of the coming Christ. They were led by the "wicked priest" who was probably that series of Hasmonean priests from Judas Maccabaeus to Alexander Jannaeus, during which time the Teacher of Righteousness was crucified.

The Essenes placed themselves in the very center of this cosmic battle between good and evil. They wrote of Belial, " Accursed be all the spirits of his lot,

in his wicked plan,

for they are the lot of Darkness,

and the lot of God is for everlasting Light.

You created Belial for the pit,

angel of enmity,

his domain is in darkness,

his counsel is for evil and wickedness.

All the spirits of his lot,

angels of destruction,

walk in the laws of darkness."

The Essenes call on Michael, the archangel of Israel, as Prince of Light to "exalt the authority of Michael over all other gods." He does battle against the Prince of Darkness,

" To assist truth,

and destroy wickedness,

to demolish darkness,

to exterminate all the sons of darkness,

and increase light."

The Sons of Light are, of course, the normal angels, angels of light led by the archangel Michael. His battle with the sons of Darkness we now know from Dr. Steiner as the legions of earthly elementary spirits led by Ahriman. The archetypal symbol of this struggle is Michael v. the Dragon or in more modern times with St. George as Michael. This battle is not unique to the Essenes, for as said in the Avesta, the battle lasts for eternity, to the end of cyclical time.

Dr. Steiner has made us familiar with the most recent scene of the battle between Michael and Ahriman, that which occurred between the years 1841 and 1879. Like all such battles, it occurred first in the spiritual worlds. There, the vanquished are banished from heaven and cast to Earth. " Losing the battle means they are no longer in the heavens, instead they are to be found in the human realms."

In this last battle, the normal archangels were preparing the angels to replace them as agents working in the human blood, so they could move on and become active in the human nervous system. However, certain retarded angels made the attempt to replace the evolving archangels in the nervous system, instead of their designated place in the blood. As the victor in this spiritual battle, Michael cast the "angels of darkness" out of the nervous system and back into the blood, where they belong. What they do in our blood is another story.

The point here is that " every battle between Michael and the dragon is similar to the one in 1840, but it is about different things. A crowd of Ahrimanic spirits seeks over and over again to bring something into world evolution, but they are always overcome." The first battle between Michael and the dragon was the so-called "War in Heaven." Here, in the planetary evolution between Jupiter and Mars, certain Spirits of Motion, belonging to the middle level of the Second Hierarchy, separated off and became "Gods of Hindrance" whose task was to oppose the Divine Plan of cosmic evolution. These spirits were in fact adversely commanded" by the higher hierarchies to cause opposition. Herein were laid the seeds of evil, for in evolution, everything repeats itself (at a higher level) and during later planetary recapitulations, what was once adverse orders, became in the future, acts of spiritual free-will. Thus,

during the Old Moon manvantara, when the earth and moon spheres separated, certain spiritual beings advanced and others remained behind, causing evil deeds again. During the Lemurian Age of our present Earth manvantara, when the moon again separated out from the earth, certain beings advanced and others remained behind, causing Luciferic angels to be cast down to earth and invade the human astral bodies.

Thus, during the normal course of planetary evolution, the first War in Heaven was repeated two more times during the subsequent stages of recapitulation. Although the beings who remained behind are characterized on the planetary scale as Luciferic spirits, when the same process is repeated during earth evolution, the same parallel separation occurs on the human scale in the microcosm with respect to the earth spirits of Ahriman/Belial.

As a result of the War in Heaven and its two subsequent planetary recapitulations, three hierarchies of evil are created, one on the level of angels, one at the level of archangels and one at the Archai level. During the middle of the Lemurian Age, Lucifer and his legion intervened in human evolution to invade the astral body and during the middle of the Atlantean Age, Ahriman and his legion intervened to invade the etheric body.

In our present Fifth Aryan Age, mankind will be visited by a new, much more powerful source of evil coming from the hierarchy of Archai/Spirits of the Age. These retarded Archai separated off the normal path of evolution of the good Archai during the Old Saturn manvanta, before the separation of the sun. Ahriman separated off during the second stage of recapitulation, when the earth-moon planet separated from the sun. Lucifer descended during the third recapitulation when the moon separated off from the earth. The hierarchy of the Archai was originally designated by the Hindu tradition at the rank of "Suras", which represented the ENTIRE hierarchy of Archai. Later, during the second cultural epoch, the Magi recognized the division within the hierarchy between good and evil, between normal and retarded Archai and renamed the hierarchy "A-Suras." The negative connotation of which would only apply to the evil suras. Because our Western tradition of angelology derives from the Magi/Chaldean/Hebrew/Essene sources, the Hindu name has come to represent the entire hierarchy.

ADZURA is the name given to the leader of the Asuras within the hierarchy of Archai. He and his legion of angels will attack the human physical body in opposition to the 7th principle of Atma. In our chart of planetary forces relating to the seven principles (infra), Saturn controls Atma and its opposition is in the moon. In the sense that Manas is a conscious transformation by the ego of the astral body, Buddhi is a conscious transformation by the ego of the etheric body, Atma is also a conscious transformation by the ego of the physical body. For most people, this transformation occurs unconsciously, during sleep and after death, by the efforts of the normal Archai. However, beginning in our cultural epoch and extending into the future epochs, Adzura will attack the conscious transformation by the ego of the physical body causing decay and disintegration. As with Ahriman, his corruptness lies in leading mankind on the path of materialism, to blind man to the source of life within the spiritual worlds.

Dr. Steiner says that,

" In the course of the earth period, man will cast away all the evil brought to him by the Luciferic spirits together with the blessing of freedom. The evil wrought by the Ahrimanic spirits can be shed in the course of karma. But the evil wrought by the Asuric powers cannot be expunged in this way. These Asuric powers will seize hold of the consciousness soul together with the 'I', to unite with earthly materiality. Fragment after fragment will be torn out of the 'I' and in the same measure that in which the Asuras establish themselves in the consciousness soul, man must leave parts of his existence behind on the earth. What thus becomes the prey of the Asuric powers will be irretrievably lost."

This leads us to the reason for the Avestan and Essene abyss.

The Eight Sphere

We have seen that the intentional cosmic deed of the War in Heaven led to the three hierarchies of evil. The Asuric, led by Adzura, resulted from the recapitulation of the Old Saturn manvantara; the Ahrimanic, led by Ahriman, resulted from the recapitulation of the Old Sun manvantara and the Luciferic, led by Lucifer, resulted from the recapitulation of the Old Moon manvantara. As a result, the evolution of the spiritual gifts (the three higher principles) given to mankind by the hierarchies are constantly under attack by these legions of evil, which we have now come to call the Spirits of Darkness. Lucifer works thru the hierarchy of angels within the astral body; Ahriman works thru the hierarchy of archangels within the etheric body and Adzura works thru the hierarchy of Archai within the physical body. The elemental spirits of Lucifer work thru the elements of air and water. The elemental spirits of Ahriman and Adzura work thru the elements of earth and fire and working with fire is much more powerful than the other elements, as the ancient Atlanteans hopefully learned.

The three hierarchies of archai-archangels-angels are reflected in the spheres of Father-Son-Holy Spirit in the regions of physical-etheric-astral bodies in man. Lucifer in his battle in the sphere of the Holy Spirit was redeemed by the act of the Christ in His descent into hell after the crucifixion. Ahriman in his battle in the sphere of the Son, will be redeemed in the future by the act of the Christ becoming the Lord of Karma. However, what is lost in the sphere of the Father, is forever lost to human evolution and the symbol of this is the abyss of the Eight sphere.

The occult concept of the Eight sphere was first made exoteric by A.P. Sinnett in his landmark book ESOTERIC BUDDHISM. Here he absolutely identified the Eight sphere with the materiality of the moon. Some of the errors he made were later corrected by the Good Madame Blavatsky in her SECRET DOCTRINE, where she hoped that future editions of Sinnett's book would finally correct the mistakes. However, this was never done and the errors still persisted leading to the conclusion that the Eight sphere was the moon, the former sphere of Lucifer during the Old Moon manvantara.

Later, when Dr. Steiner identified the nine interior levels of the earth with source levels of evil, the Eighth sphere became identified with the earth, the sphere of Ahriman. In addition, Steiner said that man could not penetrate with his consciousness the earth's interior thereby setting up an absolute barrier for knowledge of the Eighth sphere. Dr. Steiner in his book THE OCCULT MOVEMENT IN THE 19TH CENTURY (1915) tried to reconcile the two views.

As we know, seven of the 12 conditions of consciousness are available to mankind thru the evolution of the seven manvantaras from Old Saturn to Vulcan. We are presently in the fourth, the Earth manvantara. These seven spheres represent successive stages of evolution and they occur within each other, as transformations of the planet earth. Since the beginning of this Fourth round, Lucifer and Ahriman have had a plan to create or mineralize their own sphere, which at the end of planetary evolution, would detach itself from the earth and go its own way into the cosmos. This sphere has come to be called in occultism, the Eighth sphere.

In order to accomplish this task, it is necessary for a process of mineralization to occur. What are "imaginings" or thought forms in an earlier sphere, become materialized in the next sphere. Thus, the imaginings of humanity that occur during this Round, will descend from the astral world during the next Jupiter sphere and become physical. This is especially true for the great works of art and music we produce now.

During the transition from the Old Moon manvantara to the Earth manvantara, what was formerly only imaginatively perceptible, becomes materially perceptible. This occurs by adding matter to the spirit by the process of mineralization. All the imaginings present in the Old Moon manvantara, should have passed over into Earth evolution to become mineralized. However, Lucifer and Ahriman stole certain imaginings belonging to the Old Moon evolution and when these are added to the sphere of Earth evolution, an Eighth sphere is created that works in opposition to the Divine Plan of the Elohim. The Earth sphere arrives out of the Old Moon sphere by virtue of the activities of the Spirits of Motion being added to the activities of the Spirits of Form. During the Fourth globe of this Fourth round, the mineral kingdom is added to the plant and animal kingdoms that previously evolved on the Old Moon. When the activities of Lucifer and Ahriman are also added to the normal activities of the Spirits of Motion and of Form, the Eighth sphere becomes mineralized, presently with astral substance, which in the future, will become physical substance.

Now, when these stolen imaginings become mineralized during our Earth evolution, they take with them certain physical atoms that rightfully belong to our Earth evolution. What is taken away is directed by Lucifer and Ahriman into the Eighth sphere in the hope of creating their own planet. This was the planet promised to Lucifer after the War in Heaven but, as you can see from the asteroid belt between Mars and Jupiter, this planet was destroyed and only remnants remain, still in orbit. Thus, do the Spirits of Form, "Battle for every morsel of substantiality capable of mineralization lest it should be wrested away from them by Lucifer and Ahriman and borne into the Eighth sphere." As a counter-weight to the astral materiality of the Eighth sphere, the Spirits of Form mineralized the moon, with a much greater density than that of the earth. Thereafter, when the moon separated from the earth, JHVH-Elohim went with the moon to command the forces of the Elohim from there. Thus, the imaginings created during the Old Moon manvantara that were stolen by Lucifer and Ahriman which by now had mineralized into physical atoms, went out of the earth to remain in the physical moon. The mineral content of the present moon also contains the spiritual content of the Old Moon forces. As such, the major source of mineral atoms from which Old Moon imaginings could be mineralized, was removed from the earth and put back under the domain of the Spirits of Form as a physical counter-weight. However, what materiality that still remains within the earth sphere is subject to the war between the Lords of Light and the Spirits of Darkness, only the largest source has been removed.

We seen then the error of Sinnett was to mistake the astral corporality of the real Eighth sphere with the physical materiality of the moon. The moon in effect acts as a counter-weight, with its center of gravity located in the center of the moon, which is under the influence of JHVH. Like the polar field of forces of a magnet, the moon, as one pole, draws against the center of gravity within the center of the earth, as the other pole, which is under the influence of Ahriman. In the middle is the astral sphere of the Eighth sphere with Lucifer in his domain as leader of the Old Moon forces.

The astral substance of the Old Moon forces (imaginings) is the actual Eighth sphere. As the astral becomes etheric and as the etheric hardens into physical matter, so too the combined activities of the Spirits of Motion, the Spirits of Form and Lucifer/Ahriman would have passed over to the Jupiter manvantara only a shell of the earth,

while at the same time creating a physical planet to further the evolution of the Spirits of Darkness. Whether or not this will actually happen is a matter of future evolution. Since our earth is the planet destined to become a future sun in a far distant manvantara, with Christ as our leader, we do not want any competition from the Spirits of Darkness. What they really need is to capture a human soul to take with them. This has been symbolised in the past literature by the "pact with the Devil" such as seen in the 16th century HISTORIA VON D. JOHANN FAUSTEN, Christopher Marlowe's play and Goethe's FAUST. To date, no human soul has yet been lost to the Eighth sphere, including those of Nero, Ghengis Khan, Shaka Zulu and Hitler. However, can this happen in the future sixth and seventh cultural epochs ?

The Abyss

When St John received his revelation within the thunder and lightning at the Isle of Patmas, he had the historical eschatology of the Avestan, with the battle of the Amahraspands and the Devs and the Dead Sea Scrolls, with the Sons of Light and Sons of Darkness, to draw upon. Both sources had seen fit to describe the battle as one between the light and dark phases symbolized in the tropical zodiac. But what of the symbolism of the Abyss? We can see now that it is that indescribable place of the Eighth sphere.

From the darkness of pralaya ending the Old Moon manvantara, emerged the first Earth Globe, then in a dissolved condition of Arupa. During the Earth manvantara, the earth evolves thru 7 Conditions of Form, called Globes in Theosophy. They are as follows:

- | | | |
|-----------------------|-------------|---|
| 1. Higher
Devachan | | 7. Archetypal

(higher
Devachan) |
| 2. Lower
Devachan | | 6. (Lower-
Devachan)
Intellectual. |
| | 3. Astral | 5. (Plastic)
Astral |
| | 4. Physical | |

The first Arupa Globe contains in dissolved form all the evolutionary forms reduced to seeds and imaginations passed over to earth evolution from the Old Moon manvantara, except for those stolen by Lucifer/Ahriman. These imaginations were present in a formless state as pure thoughts of the Spirits of Form, whose task it was to develop this earth and instill into mankind their Fourth Principle-the human (group) ego. When the Arupa sphere condensed, the Rupa sphere emerged with more densified thought-forms, which contained the thought forms of the human, animal and plant kingdoms. When the Rupa sphere densified, the Spirits of form poured out its astral matter filling these thought forms with shape, light and color. Then, during our fourth globe, the mineral kingdom descended bringing about our 7 evolutionary Ages, from the Polarian thru the Seventh root Race which passes thru $7 \times 7 = 49$ sub-races/cultural epochs.

During the Polarian Age, the sun-earth-moon were still united in one cosmic globe in the shape of a sort of figure 8 double donut. Man and the other kingdoms had not yet descended into physical form. During the Hyperborean Age, the earth-moon planet separated off the sun and the Apollo men, sons of the Solar Pitris, descended into beautiful human forms. During the Lemurian Age, the moon separated off the earth and the Lunar Pitris descended into ugly, primitive human bodies. This Age was the beginning of sexual evolution and during the middle, the Luciferic angels penetrated man's astral body. Those that "refused to incarnate" went into pralaya on the various planets waiting for more favorable conditions. During the Atlantean Age, these human souls returned to earth and incarnated into mankind achieving racial evolution thru 7×7 sub-races. During our Fifth Aryan Age, the racial characteristics of mankind recede into the background and heredity evolves thru 7 cultural epochs. During the future Sixth Age of the 7 Seals, humanity evolves so that its karma is carried on the human countenance. It will no longer matter into what racial group one is born, the mark of evil will be carried on the forehead, like the mark of Cain. In a pre-figuration of 6-6-6, mankind will be separated into two classes of good and evil. During the last seventh Age of the trumpets, the course elements of the earth will manifest as brutal conditions of nature as described in REV:8. After the trumpet blast of the seventh angel, earth evolution as we know it (for this manvantara) will cease.

Thereafter, begins the ascent of the Fifth, Sixth and Seventh Globes into spiritualization in contra-distinction to the previous descent of the three Globes into matter. This is recognized in the APOCALYPSE by the descent of Heavenly Jerusalem, the more-perfect astral world of human imaginations. On the downward curve, the thoughts, thought forms and astral substance was sacrificed and given to mankind by JHVH and his legions. During the upward curve, the earth and all of its creations will dissolve into a seed condition into this heavenly astral globe.

There will be a repetition of the conditions that prevailed during the Hyperborean and Polarean Ages. All matter will dissolve and during the Seventh Globe, the earth will re-unite with the sun.

In this ascending astral globe, a separation must occur before the earth passes over into the Jupiter manvantara. Humans will have spiritualized themselves and with the Christ impulse inside, will raise up the finer particles of earthly matter and unite with the sun, with Christ as the leader. Those persons under the influence of the Spirits of Darkness will have not progressed far enough in evolution so as to be a material and corporal expression of the good. They will not have the power to dissolve matter and can not ascend into this astral Globe. That portion of the earth that has remained coarse and those humans who have remained behind in their etheric form of the Beast, will be united with the Eighth sphere. As Dr. Steiner says, " There will come the time when the insoluble part will be ejected as a separate globe, a new kind of moon." In the transition from the recapitulation of the Hyper-borean Age to the Polarean Age, when the earth is re-united with the sun, all the Old Moon forces must be ejected for a final time for they can not co-exist within the brilliance of the Sun-Devachan sphere. For this reason, the Eighth sphere exists, like a comet, to take away all the cosmic astrality of the Spirits of Darkness.

Thus, the new earth with its carried over seed from that emerges from the pralaya into the Jupiter manvantara, will be accompanied by a satellite (a moon) consisting of the physical matter of the Eighth sphere. This final Arupa/Archetypal Globe is symbolized in the APOCALYPSE as a "woman clothed in the sun, the moon under her feet and upon her head, a crown of 12 stars," REV:12:1. The moon under her feet is, of course, the cosmic astrality of the Old Moon forces mineralized into a satellite moon and represents the victory of the purified human astral body, having expunged the Luciferic forces.

The Final Solution of the eternal battle between good and evil is that mankind is separated into two classes during the future Sixth root race. The second dragon REV:13:1 arises from the sea of human souls that have remained behind having failed to purify their astral bodies of animal passions and instincts. The Beast with seven heads and ten horns represents the Atlantean etheric form that has still remained behind during the fifth and sixth root races. These people will be separated out from those of the "white robes" who bear the Christ impulse. These damned human souls will be cast into the "bottomless pit" from which will arise the first dragon REV:12:3. This dragon is a symbol for those Luciferic/Ahrimanic elemental beings that can not be united with the sun in its final astral stage. When the earth unites with the sun, a dragon appears in Heaven, because he comes from higher worlds than the sea, whose beings remain in their original condition and are cast back into the lower astral world.

Thus, the Final Solution deals with first, human souls who have remained behind in their evolution, represented in the APOCALYPSE by the second/dragon Beast with 7 heads and 10 horns; and second, the elemental beings of Lucifer/Ahriman represented by the ancient symbolism of the snake/first dragon.

Although the symbolism described by St. John is graphic and unimpeachable, it does give the impression that after the descent of the Heavenly Jerusalem, the final solution ends all. All those souls that can be saved, are saved and damn the remainder, cast into the abyss. This is true in so far as respects the Fourth Earth manvantara. However, the earth becomes physical three more times during each of the Jupiter, Venus and Vulcan manvantaras. Those Luciferis/Ahrimanic elementals symbolized by the second dragon will reappear during the Jupiter manvantara as corrupt nature spirits. In the sense that the Old Moon was a cosmos of Wisdom and the Earth Globe is a cosmos of Love, those beings that remained behind on Old Moon evolution become destructive forces during the Earth Globe. Likewise, these beings that remain behind during the Earth globe will become destructive forces of Love working against the Divine Plan during the evolution of the Jupiter Globe.

As for the human souls who have ascended so far as to entirely perfect their astral bodies into a crystalized form, like that of Buddha, their angels will be released to work with the Spirits of Light on special missions directed by the Hierarchies. These human souls themselves will rise to the rank of angels sacrificing their physical bodies for future mankind evolving on the Jupiter Globe.

As for those humans who have not entirely perfected their astral bodies, but have more good than evil, they will incarnate again into more earth lives during the Jupiter and Venus Globes to progress along the path of salvation. So, most people get many more chances. However, there are human souls that have used up their complete cycle of incarnations and for them, there are no more human forms in which to incarnate again. They will also become nature spirits during the Jupiter Globe.

Thus, the real Final Solution only occurs at the number of 6-6-6 during the Sixth root race of the Venus Globe. This is the last moment for salvation. Those who are not saved will be cast into the FINAL abyss and form the egregore from which a physical body will incarnate bearing the Anti-Christ, whose number is Sorath, the sun-demon. This image is preserved in the APOCALYPSE as the Fall of Babylon REV:17,18. For when the final Vulcan Globe arises, the Earth-Sun will be completely purified of all the cosmic astrality of all forces remaining over from the previous Six manvantaras. Lucifer and Ahriman will have been redeemed. Adzura and Sorath will have been defeated and cast into the Eighth sphere, and like a comet, pass out of our solar system forever.

THE SOLSTITIAL GATES OF THE WORLD CROSS

Our goal is to explain some of the contradictions inherent in the traditional symbolism of the zodiac, there is no better place to start than with the confusion of tongues generated by that most contradictory of all traditional symbologists, Rene Guenon, (hereinafter R.G.).

One favorite epistemological approach R.G. utilizes can be called the "First Confuse, then Explain with less than an answer" doctrine. This leaves the reader with a poor understanding and a feeling of stupidity, both of which were probably intended by him.

For example, in dealing with the traditional symbolism of the annual solar cycle of the tropical zodiac, R.G. discusses the contradictions between the placement of the gates of entry to the north/south polar axis as they relate to the SOLSTITIAL GATES. In an article by that name, he criticizes the traditional occult designations known to Western occultism since the time of Macrobius and Porphyry, as the Gate of the Sun (God) and the Gate of Man. Traditionally, the Gate of Man was that zodiacal house where the soul, before birth and intended for incarnation on earth, would descend into the moon sphere waiting for re-birth. The Gate of the Sun was that zodiacal house wherein the human soul, after death, would ascend into the planetary spheres beyond the moon sphere, for its sojourn thru the spiritual worlds, to meet God. Other than the 19th century occult attempt within Spiritualism to identify the loka of deceased human souls as solely residing within the moon sphere, the Ancient Wisdom taught that the soul after death, traveled first, to the successive spheres of moon-mercury-venus-sun on its outward journey. During this ascending stage, the soul reflected on and paid penance for the sins of the past life. This ascending stage ended with what was called "cosmic midnight."

Thereafter, the second half of the souls journey began wherein the soul descended thru the same spheres again on its downward path into incarnation on earth and passing thru the Gate of Man to enter the moon sphere to await rebirth with millions of other souls. While during the first half of the journey, the soul reflected upon and suffered for the sins of its past life, during the second half the soul takes in those forces necessary to build up his future astral, etheric and physical bodies. These forces include both preparing its future karma and learning the wisdom taught by the spirits residing in the different planetary spheres. For example, if one's future karma demanded a person to become a physician, he must learn medicine and spend time within the sphere of Mercury with the archangel Raphael.

In between the ascending and descending transits, in order to build up its future bodies, the soul must also travel into the sphere of the zodiac wherein the creative forces of the human melothesia reside. Thus, after the soul's stay in heaven/devachan, it travels thru the spheres of Mars, Jupiter and Saturn to build up the triad of its higher spiritual bodies, Manas, Buddhi and Atma (at the present time, these visits are brief or existent for most persons, since these bodies are very undeveloped). Then, the soul must procure a guide and make the jump from Saturn into the sphere of the zodiac.

R.G. in his analysis of the Western tradition says that Proclus, Porphyry, Macrobius and Numenius all confuse and contradict the traditional Greek doctrine of Pythagoras. Of modern occultists he says, "the incomprehension of modern academics create divergences and contradictions, which are really not there at all."

The problems that are "really not there at all", of course, disappear when one considers the Hindu doctrine of Diva/Pitri Yana. In explaining his own traditional forms, R.G. First confuses, then gives a less than satisfactory answer. Consider first the analogy:

"The gate of Men and the Gate of the gods, inevitably must correspond to the two solstices. We must now state more explicitly that the first corresponds to the summer solstice, or to the sign of Cancer and the second to the winter solstice, or the sign of Capricorn. In order to understand the reason for this, it is necessary to refer to the division of the annual cycle into two halves, the one ascending and the other descending. The first is the period of the movement of the sun towards the north, going from winter to summer solstice,; the second is that of the movement of the sun towards the south, going from the summer to the winter solstice. In the Hindu tradition, the ascendant phase relates to the deva-yana and the descendant phase to the pitri-yana which coincides exactly with the designations of the two gateways we have just mentioned."

Then, the consider the confusion when R.G. says exactly the opposite:

"The solstitial gate of winter, or the sign of Capricorn, corresponds to the North in the annual cycle, but to the south as regards the path of the sun in the heavens; similarly, the summer solstitial gate, or the sign of Cancer, corresponds to the South in the annual cycle and to the North as regards the path of the sun. This is why, while the ascendant movement of the sun goes from south to North, and its descendant movement from North to South, the ascendant period of the year must be regarded, on the contrary as being accomplished in moving from North to south and its descendant period in moving from South to North."

In addition, her further confuses the matter by saying:

"After being manifested here in a certain state, this (human) being will go out from it by one of the two gates according to the spiritual degree which it has reached. In one case, that of pitri-yana, it will have to return to another state of manifestation which naturally will be represented by a re-entry into the cosmic cave. In the other case, on the contrary, that of the deva-yana, there is no further return to the manifested world. One of these two gates is thus both an entry and an exit, while the other is a final exit."

Thus, the gate of pitri-yana is a gate for a series of individual incarnations and the gate of deva-yana serves as the gate at the end of the cycle of incarnations, a final exit.

After a criticism of the traditional Western occult forms, he explains the superiority of the Hindu system, but with a less than satisfactory answer:

"The solution of this difficulty lies in the distinction that can be made between the 'celestial' order to which the progress of the sun belongs, and the terrestrial' order to which belongs the succession of the seasons."

But in this answer does lie the wisdom of the solution. For in the "celestial" order (the path of the sun in the heavens) we have the sun's movement in the sidereal zodiac and in the terrestrial" order (the path of the sun in the annual cycle), we have the sun's motion in the tropical zodiac. Using the distinctions established in our (above) discussion of the differences between the two zodiacs, we should be able to make sense out of this intentional confusion.

First, in relation to the tropical zodiac, we can establish a North/South polar axis as the winter/summer solstitial axis and an East/West horizontal axis as the vernal/autumnal equinoctial axis. Together they form a relatively vertical axis in the shape of the cross. At the winter solstice is the house of Capricorn and at the summer solstice is the house of Cancer. Thus, the ascendant cycle, going from south to north, corresponds to our " Breath of the Earth " as inhalation.

BREATH OF THE EARTH CYCLE

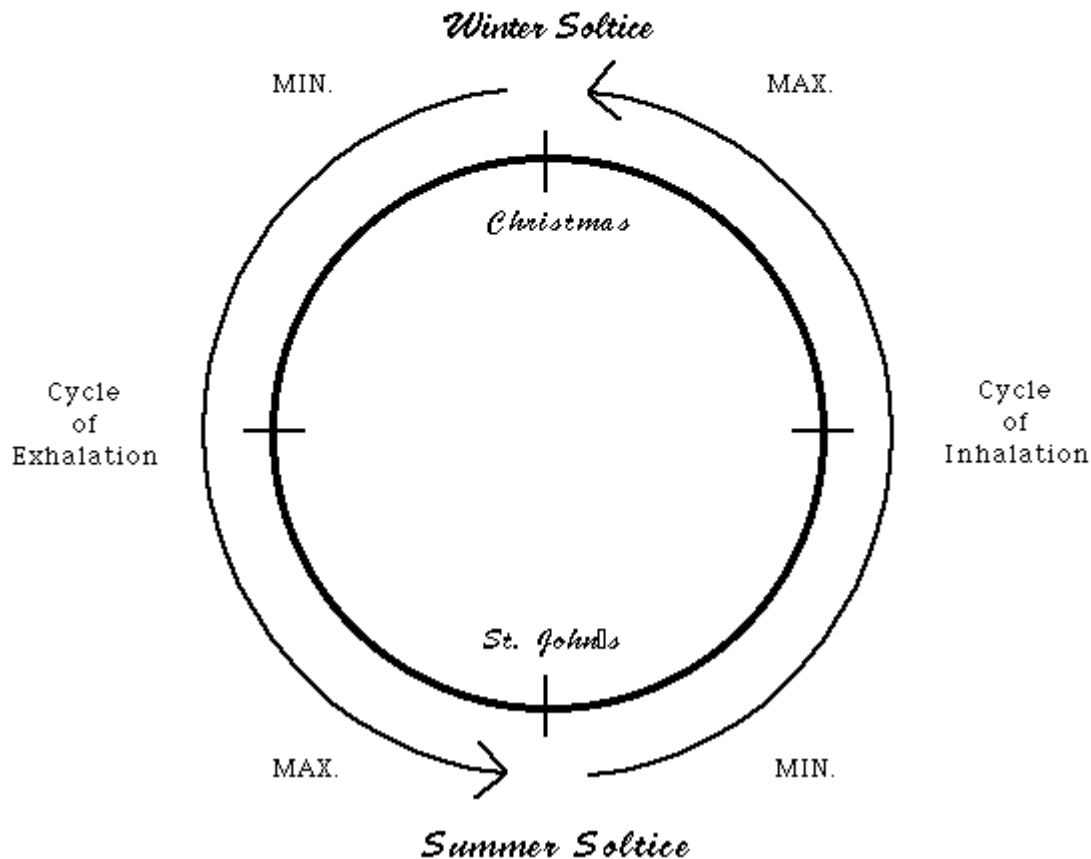

The descendant cycle, going from north to south, corresponds to our breath of the earth, as exhalation. The maximum peak of inhalation being the winter solstice and the maximum peak of exhalation, being the summer solstice.

Thus, for R.G. and the Vedantic symbolism, the gateway of deva-yana is situated towards the north and the gateway of deva-yana is situated towards the south. In fact, the cross that symbolizes the annual cycle of the tropical zodiac, is not exactly perpendicular as we described above. Its actual shape is what Madame H.P.B. calls the "decussated cross in space" which Plato described as "the second god who impressed himself on the universe in the shape of a cross." This Platonic symbol of the Second Logos crucified as the world soul upon the world cross in space is the origin of all symbolism of the cross and the crucifixion.

R.G. recognizes this fact of the world cross not being exactly perpendicular but more in the shape of an elliptical cross, like this, "X", when he says:

"It can be said with still greater precision, that the gateway of the gods is at the north and turned towards the east which is always considered as the side of light and life and that the gateway of men is at the south and turned towards the west, which is considered as the side of darkness and death."

Thus, in our Western tradition, the Greeks described the "descent into generation" into re-birth, by the tropical gate of Cancer and the "ascent to god" of the soul after death, by the tropical gate of Capricorn, in which the soul ascends into the spiritual ether of the planetary spheres.

Therefore, the traditional symbolism of the gate of god to the north in Capricorn and the gate of men to the south in Cancer, is nothing more than our annual ascending and descending phases of the tropical zodiac. Furthermore, it is within this zodiac that occurs the souls cycles of regular incarnations, prior to the "final exit." Hopefully, we now have a simple explanation based upon our (above) distinctions between the two zodiacs.

But what is the significance of the reversed polarity described by Porpyry when, first, the gate of Cancer is in the north and the gate of Capricorn is in the South? And second, what is the significance of the final exit thru the gate of deva-yana when there is no further return to the manifest world?

To answer these two questions do we really need R.G.'s explanation that, "According to the general law of analogy, these two orders must be, in their very correlation, the inverse of one another, in such a way that what is highest in the one becomes in the lowest in the other, according to the Hermetic dictum of the EMERALD TABLE." I hope not!!!

The answer to the first question is also very simple, for what is the reverse of the tropical zodiac? The sidereal zodiac, of course. Transposing our elliptical cross of the tropical zodiac over to the axial plane of the sidereal zodiac, gives us the symbolism of Porpyry with the reversed polarity of ascending and descending forces. Now we can say that the ascending forces of the sidereal sun "in the heavens" goes from north to south and the descending forces of the sidereal sun goes from south to north. Then our two gates are reversed in direction to accommodate the clock-wise direction of the sidereal sun in celestial longitude as opposite to the counter-clockwise direction of the tropical sun in its annual course in celestial latitude. It should be kept in mind that when we speak of the reversed polarity of the gates in the sidereal zodiac, we no longer are talking about the gate of pitri-yana and the regular cycle of incarnations, but of the other gate, that of the final exit.

What is the meaning of the "final exit" at the gate of deva-yana, when there is no further return to the manifest world? We saw that the tropical zodiac was a symbol for the cycle of individual incarnations of the soul which necessarily must enter and exit many times over the course of the reincarnating ego. However, there comes an end to this cycle, which for Buddha, was his entrance into Nirvana, after which there is no further return into manifestation. The cycle of earth lives is over. For other human souls who achieve less than perfection, one can either use up its allotment and wait for the next manvantara or fall out of evolution completely.

The sidereal zodiac controls the souls celestial paths of incarnation. IDEALLY, the souls paths of incarnation follows the houses of the zodiac in the reversed order of the sidereal zodiac over the course of cosmic time in the 25,920 year cycle of the great solar sidereal year. The Divine Plan laid down by the Spirits of Form intended each cycle of incarnation to last approximately the 2,160 years of the cycle of the Spirits of the Age. Thus, the soul in passing thru its regular cycle of incarnations within the tropical zodiac sphere, returns 12 times in cycles based upon the sun's progression thru the vernal equinox from one house to the next.

Again, ideally, Dr. Steiner explained that if the soul spends about one-third of his lifetime in Kama-loka or purgatory, this would amount to about thirty years for the average person. The Divine Plan provided for the soul to spend about twelve times as much time in each of the remaining spheres or about 360 years each. As the soul passes in both directions thru the three spheres of the first, second and third Angelic Hierarchies, this would constitute six cycles in all. Three spheres in the ascending phase (reflecting and repenting for the past sins of karma) and three spheres in the descending phase (building up the cosmic bodies for the next incarnation). Between the outward journey and the backward journey, the soul would spend about 2,160 years, plus or minus the 30 years spent in Kama-loka. However, for modern man, the length of each incarnation has been considerably shortened for the following reasons.

Of course, it is the history of evil that road blocks are laid against the path of the Divine Plan of the Elohim. The first cause of the shortened return was made by the Elohim itself as a response to the invading of the astral body by the Luciferic spirits during the middle of the Lemurian Age. YHVH, as Elohim, actually caused the "fall into generation" by establishing the physical process of heredity to give incarnating souls many chances thru repeated earth lives in order to purify the invaded astral body. Repeated earth lives in itself was the actual solution created by the Elohim to fulfill the redemption of Lucifer, which redemption began at the crucifixion of Christ. Thus, when the Lemurian androgyne split into two soul mates, each male and female, the period in incarnation was halved into a period of 1080 years for each male/female incarnation.

The second act has evolved over time by the influences of Ahriman pulling the soul back towards earth for grounding in earthly materiality. This occurs most frequently in the period after the Cosmic Midnight when the length of stay in the third Hierarchy is deliberately shortened by the forces of Ahriman. For example, a criminal who

has not controlled his animal impulses and lives within the instincts and passions of the (Apocalypse) Beast, will incarnate much sooner than normal. His travel into the Third Hierarchy within the spheres of Mars, Jupiter and Saturn will be outright rejected.

This is also true for a person with strong materialist tenancies. The higher triad of spiritual bodies are so undeveloped, that there are no developed corresponding spiritual organs to take in the impulses available there. In fact, the asteroid belt between Mars and Jupiter serves as a barrier to prevent souls from going to these higher spheres of the third Hierarchy until the souls have evolved sufficiently. Thus, Dr. Steiner says that the normal length of time between incarnations for modern man has been reduced to about 700 or 800 years, even shorter for those persons above described. There are of course, good people who have a shortened cycle, these being persons on a special spiritual mission that was not completed.

It can now be said that when a person has completed his allotted cycle of incarnations in the sidereal zodiac, the soul passes thru the deva-yana gate and will not return earth life. This is what R.G. called the final exit. It is reflected in the sidereal zodiac when Porpyry describes the gate of Cancer that is in the north and the opposite gate of Capricorn that is in the south. The confusion caused by the reversed polarity occurs because the authors fail to distinguish between the two zodiacs.

Further, the course of incarnations within the sidereal zodiac are governed by what Dr. Steiner calls the "Spirits of the Rotation of Times" (presumably, the Spirits of Motion ranked in the middle of the second angelic Hierarchy). The original Divine Plan provided for the spirits of Wisdom to control the incarnation of the "human individuality". However, since these spirits are primarily interested in Wisdom, as such, they would have pressed together all possible human perfections gained from repeated earth lives into ONE single incarnation. This, of course, would have made man infinitely wise, but only at the expense of Love. What a man in his "personalty" develops thru the element of love over time and repeated earth lives, is enduring for his individuality. Therefore, the Divine Plan was changed to allow repeated earth lives of the personalty (ego) to develop the impulse of love, which is the leading characteristic of this Earth manvantara. Steiner says that "the spirits of Wisdom became Spirits of the Rotation of Times" so that "the successive incarnations of man were regulated in the successive revolutions of time which were again regulated through the course of the stars."

These stars are, of course, the stars of our sidereal zodiac. The human "personalty" of successive earth lives is the incarnating ego within the cycles of pitri-yana. It is the human "individ-uality" that is the eternal higher ego radiating forth as the Buddhi principle which exits at the end of the great cycle thru the gate of deva-yana.

In conclusion, we have tried to show that if one preserves the distinction between the tropical and sidereal zodiacs, the confused symbolism of the solstitial gates becomes clear. It is the tropical zodiac that serves as the background within the larger solar sidereal cycle for the entry and exit into the limited cycle of repeated earth lives. Herein, Capricorn serves as the winter gate and Cancer as the summer gate, both being pitri-yana. It is the sidereal zodiac that serves as the background for the regulation of individual incarnations, according to the cosmic cycle of the great solar sidereal year, at the end of which, the soul makes its final exit thru the gate of deva-yana, into higher manifestation. This cycle of incarnations precessing through out the sidereal zodiac is what is known as the "12 Initiations into the Zodiac."

THE BREATH OF THE EARTH CYCLE

We made reference in the last section about the ascendant cycle, going from summer solstice to winter solstice, corresponding to our "breath of the earth", as inhalation. And the descendant cycle, going from winter solstice to summer solstice, corresponding to our "breath of the earth", as exhalation.(see BREATH OF THE EARTH plat) Also, when speaking of the differences between the two zodiacs, we said that the annual cycle of the tropical zodiac was one "earth breath", while one degree of the cycle of the sidereal zodiac was 72 earth breaths. Likewise, 360 degrees of the sidereal zodiac is equal to 25,920 earth breaths.

Now, the cycle of light within the tropical zodiac goes from equinox to equinox, while the cycle of the earth's breath goes from solstice to solstice. As symbols of the winter and summer solstice, we have Christmas and St. John's day. We have discussed what happens in nature during the equinox cycle, but what happens during the solstitial cycle ? As a human, we breathe air in and out over a rythm of approximately 25,920 times per day. This way our microcosmic daily cycle comes related to our macrocosmic solar sidereal year cycle. But, the earth also breaths in and out, not with air, but with the forces of elementary nature spirits.

At Christmas time, the elementary soul forces of the earth are totally inhaled or fully in-breathed, just as in a man whose breath is fully inhaled. For good reason, the birth of Christ is celebrated at this time of the year, even though it is more likely, He was actually born at midnite around December 6/7. The Ancient Wisdom recognized that at the winter solstice, the entire soul element of the earth was entirely contained within itself.

Just the opposite occurs at the summer solstice, celebrated as the pagan Midsummer and the Christian St. John's day. At this time, the earth has totally exhaled or fully out-breathed. All the elementary soul forces that were once contained within the earth at winter solstice, are poured forth into cosmic space.

Ahriman is that leading spirit of the earth whose being and body consists of the combined forces of all the elementary spirits of nature. He is that true being of nature thru which the angelic hierarchies make use of his spirit to produce the phenomenon of nature. These elementary nature spirits are breathed out during the spring to cause the "growth" cycle of nature within the tropical zodiac. During the fall, these same elementary spirits cause the "decay" cycle in nature. Thus, at the summer solstice, the earth is fully Ahrimanized and at the winter solstice, the earth is fully, for lack of a better word, Christianized.

Between the twin peaks of the solstices, the Ancient Wisdom recognized that it was the archangel Michael who fought the forces of Ahriman, symbolized as the dragon. For this reason, the festival of St. Michael was placed near the fall equinox on September 29th. Then, Michael could purify the earthly Ahrimanic forces of decay and death before the normal inhalation cycle is completed. As Christmas approaches, the forces of the dragon lie beneath His feet and Michael unites with the inhaling breath of the earth, so that the winter festival is as pure as the snow that covers the earth in celebration.

These festivals of Christmas, St. John's day and St. Michael's day are all fixed, but in the spring, the Easter festival is moveable, to accommodate the cosmic date of the Neomenia. Spring, is the release of elementary nature spirits from the breath of the earth and does actually begin on the Neomenia, the first new moon after the vernal equinox.

However, it came to be celebrated as the Christian festival of Easter on the first Sunday after the first full moon after the vernal equinox.

Easter is not meant to celebrate the first day of spring, but the first SUN-Day to celebrate the resurrection of the Sun-Spirit, Christ, in his victory over death. The ascending cycle from winter to summer solstice, is a cycle of exhalation for the earth. The Ancient Wisdom recognized that: (1) the out-flowing forces of the sun coming towards the earth and (2) the out-flowing forces of the earth, unite at Easter time. Since Easter is a celebration of the united sun and earth forces, the Ancient Wisdom did not want any interference coming from the forces of the moon. For this reason, Easter was set after the first full moon, so that the out-pouring forces of the earth at Easter would not be reflected back towards the earth by the mirror-like face of the full moon and interfering with the cosmic union of the earth and sun forces.

This secret of the Ancient Wisdom was a battleground between Roman and Celtic Catholicism over the fixing of the date for Easter, particularly in the event that the first Sunday and the first full moon fell on the same day. The Celtic practice was to celebrate Easter on the Sunday of a full moon, while the Roman practice was to postpone Easter until one week later, after the full moon. Although the Roman church fathers made many mistakes in applying the Ancient Wisdom to ecclesiastical events, they were correct on this issue and prevailed at the great council of 664 AD held by King Oswy.

The Easter celebration also marked a transition for the Ancient Mystery tradition from lunar consciousness to solar consciousness. Prior to the mystery of Golgotha, Easter, as a celebration of "Death and Resurrection", was a mystery directed at the moon influences controlling nature. The revelations of the Sun-Spirit were seldom experienced by direct observation of the sun, (eg., the Celtic dolmens) but always experienced indirectly as reflections from the moon. It is in this sense that Dr. Steiner always referred to the moon Elohim, YHVH, as the reflected Christ.

In the pre-Christian era, the mystery of Death and Resurrection was celebrated during the fall equinox as the Adonis Festivals of Asia Minor. Exoterically, a sculptured image of Adonis was lowered into a lake (as a symbol for the cosmic ether) and left there for three days while the citizens prayed and acted remorseful. Afterwards, the icon was drawn out of the lake and the citizens celebrated with parties and festivities. Esoterically, the initiate was laid in a coffin for three days, during which time his Hierophant took him on tour of the spiritual worlds. First, the etheric body was directed to experience the elementary etheric sphere between the earth and the moon. This experience corresponds to death itself, when after the death of the physical body, the etheric body reviews the memory tableau of the past life and then disperses into the etheric sphere. Afterwards, the astral body and ego were directed to experience the astral spheres between the moon and sun. The final initiation was the single experience of Christ in the sun sphere and the successful candidate was henceforth referred to as a "Christophoros."

For the initiate, the return to the physical body after the three coffin days in the spiritual world, corresponds to a "resurrection" in which he was "born again." In present day, the etheric body can no longer be separated from the physical body without causing death, so this form of initiation can no longer take place. However, the astral body and ego still separate every nite during sleep.

The Adonis mysteries were "solar" in direction and experience while, the Ephesus mysteries of Diana and Artemis were "lunar" in orientation. During the greater solar Egyptian mysteries of Osiris, the initiates learned that Christ could no longer be found in the sun sphere, since He had begun His veiled descent thru the planetary spheres to

earth for incarnation. After the mystery of Golgotha, the solar initiates realized that Christ was both that former Sun-Spirit as well as the Nathan Jesus. Henceforth, these initiates decided to transfer the mysteries of Death and Resurrection from the fall equinox to the vernal equinox of the Easter festival and celebrate the Death and Resurrection of Christ. In doing this, the orientation of initiatic wisdom changed from the moon sphere to the sun sphere.

Unfortunately, this mystery wisdom of Christ as the Sun-Spirit known to the early (solar) church fathers became suppressed and destroyed during the 4th century Romanization of the Catholic church. However, the souls of these cosmic Christians went on to participate in the school of St. Michael in heaven during the 15th-16th-17th centuries and they still incarnate on earth within the Platonic stream. Fortunately, over the centuries, Easter remains still a remembrance of the Death and Resurrection, although it has lost its cosmic significance.

In conclusion, when we look at the cycle of light of the tropical zodiac, we see ascending and descending forces centered around the equinoxes. In the annual cycle of the Breath of the Earth, we see the same ascending and descending cycles, but they are centered around the solstices. Instead of a cycle of light which derives from the sun forces, we see a cycle of elementary nature spirits that derives from the earth forces of Ahriman. What scientists now call "nitrogen fixing bacteria", the peasant wisdom called gnomes, which do their work in winter time when these elementary beings are trapped inside the inhaled breath of the earth. This is why the peasants fertilized in the fall and not in the spring, as in the modern method

THE SON OF GOD and THE SON OF MAN **The Macro and Micro Cosmic Principles of the Cosmic Christ** THE DOCETIC VISION

It can be said that the principal of Doceticism had its origin in the so-called Apocryphal Gospels/Acts of the Alexandrian gnostics. The Islamic scholar extra-ordinaire, Henry Corbin, begins his treatise on Doceticism and Ismailian Gnosis with a story from the Apocryphal Acts of Peter (sec. XX-XXI). The apostle Peter was describing his experience on the holy mount at the scene of the Transfiguration to a group of people, including several widows, one of whom was blind. Peter says the following.

"Our Lord, willing that I should behold his majesty in the holy mount, I, when I with the sons of Zebedee saw the brightness of his light, fell as one dead and shut mine eyes, and heard such a voice from him as I am not able to describe, and thought myself to be blinded by his brightness. And when I recovered (breathed again) a little I said within myself: Peradventure my Lord hath brought me hither that he might blind me. And I said: If this also be thy will, Lord, I resist not. And he gave me his hand and raised me up; and when I arose I saw him again in such a form as I was able to take in."

Now, the operative words in this experience are "when I arose I saw him again in such a form as I was able to take in."

In another Apocryphal gospel, the Acts of John (sec. 88-89), the brothers James and John were describing the calling of the apostles by Jesus, as follows.

"For when he had chosen Peter and Andrew, which were brethren, he cometh unto me and James my brother, saying: I have need of you, come unto me. And my brother hearing that, said: John, what would this child have that is upon the sea-shore and called us? And I said: What child? And he said to me again: That which beckoneth to us. And I answered: Because of our long watch we have kept at sea, thou seest not aright, my brother James; but seest thou not the man that standeth there, comely and fair and of a cheerful countenance? But he said to me: Him I see not, brother; but let us go forth and we shall see what he would have."

Here, these two apostles in beholding Jesus, describe first seeing a child calling them from the shore, then later again, this same person appears to them as a cheerful man of noble appearance. A few articles later in the Acts of John, John describes his vision of the figure of Jesus during the Transfiguration in varying degrees of transcendence as follows.

"And at another time he taketh with him me and James and Peter unto the mountain where he was wont to pray, and we saw in him a light such as it is not possible for a man that useth corruptible (mortal) speech to describe what it was like. Again in like manner he bringeth us three up into the mountain, saying: Come ye with me. And we went again: and we saw him at a distance praying. I, therefore, because he loved me, drew nigh unto him softly, as though he could not see me, and stood looking upon his hinder parts: and I saw that he was not in any wise clad with garments, but was seen of us naked, and not in any wise as a man, and that his feet were whiter than any snow, so that the earth there was lighted up by his feet, and that his head touched the heaven"

Finally, we can hear this same John of the Apocryphal Acts describe himself in varying degrees of transcendence as follows.

"Thou hearest that I suffered, yet did I not suffer; that I suffered not, yet did I suffer; that I was pierced, yet I was not smitten; hanged, and I was not hanged; that blood flowed from me, and it flowed not; and, in a word, what they say of me, that befell me not, but what they say not, that did I suffer."

For Henry Corbin, Doceticism is not a set doctrine but a tendency for THEOPHANIC VISIONS by the person actively engaged in a spiritual experience of perception of angelic beings. For him,

" There is actual perception of an object, of a concrete person: the figure and the features are sharply defined, and yet it is not given to the perception of the sense organs. This perception is essentially an *event of the soul*, taking place *in* the soul and *for* the soul. As such its reality is essentially *individuated* for and with each soul; what the soul really sees, it is in each case alone in seeing. The field of its vision, its horizon, is in every case defined by the capacity, the dimension of its own being."

John in the Acts defines this principal with his simple formula "I saw him again in such a form as I was able to take in." This comment essentially defines Doceticism as a theophanic vision which in every case is proportional to the theophanic dimension or capacity of the soul of the beholder.

Thus, for the gnostic christian, Jesus did not suffer and die to the cross, only the simulacrum of his body, which suffered only in appearance. Although the gnostics possessed the tradition of the ancient wisdom, they could never understand the profundity of the incarnation of Christ in the Son of Man. This is in part the fault of the Ancient Wisdom itself, which always held that a god could not die to the earth, could not die on the physical plane. This tradition was expressly Hindu and Buddhist, wherein the incarnating spirit of both the Avatara and the Buddha, exited the physical body just prior to death. In fact, the adept actually practiced during his lifetime the technique, called mahasamadhi, of allowing the spirit to travel up the spine and depart the head thru the pineal gland. Even in the 20th. century we see in the death of Paramahansa Yogananda, the vital signs of his physical body surviving some 20-30 days after death. The same phenomenon is also well respected in the many preserved bodies of saints of the catholic church.

Traces of this gnostic Doceticism survived briefly in the works of Origen and Manichaeism, but found a foothold in the doctrines of the judeao-christian tradition of Ebionite Christianity. Ebionism had two major doctrines that ran counter to Pauline Christianity. First was the primacy of brother James as Bishop of Jerusalem over peter as Bishop of Rome. There was an ancient tradition that it was Saul who pushed James to his injury from the pinnacle of the temple and while surviving the fall, had him beaten to death with a fuller's club. This may be a karmic source to the hostility to Pauline Christianity.

The second doctrine was that of the True Prophet as incarnated in Adam. For the Ebionites, the first man was the first form or vehicle of the True Prophet, sort of an Adam-Christos, which for Anthroposophists, would be akin to Adam and his sister-soul, the Nathan Jesus soul. The True Prophet was foretold by Moses in a succession of epiphanic forms, in the incarnations of Enoch, Noah, Abraham, Isaac, Jacob, Moses and Jesus. Judaism was a prophetic mystery stream and when this Ebionite tradition was carried over only a few centuries later to Islam, there appeared in Ismaili gnosis the doctrine of the Imam and its spokesperson, the prophet. (The Gnostic thread that also carried over to Manichaeism had a similar succession of True Prophets in Adam, Seth, Noah, Jesus, Buddha, Zoroaster and Mani).

By the time the Koran was written down we see a docetic verse that says "They slew Him not nor crucified, but it appeared so unto them, and lo! Those who disagree concerning it are in doubt thereof; they have no knowledge thereof save pursuit of a conjecture. They slew Him not for certain." Thus, the docetic vision, carried forward thru Gnosticism, Ebionism and finally into Islam, does not deny the hypostatic union of the Christ spirit in Jesus of Nazareth, but denies that the Christ spirit died to the cross. For them the penultimate words of Jesus on the cross "MY God, MY God, why has thou LEFT ME" are literally true. The Nathan-Christ spirit must have fled the body of the Solomon Jesus before the physical death on Golgotha.

THE FLEEING NAKED YOUTH

This docetic problem still exists to this day. It is Nicene Creed dogma for the catholic church that the two natures of Christ were united in one person, which godly person suffered and died on the cross. Like wise, for anthroposophy, it is dogma that the Christ was the first god to suffer death on the physical plane.

In a lecture 2 April 1922 Steiner says,

"Thus the Mystery of Golgotha meant this for the gods: a greater wealth of knowledge through the wisdom of death. If a god had not passed through death, the whole Earth would have become entirely intellectual, without ever reaching the evolution which the gods had planned for it from the very beginning.

"But the esoteric element which Christ gave to his initiated disciples consisted therein, that He told them: What took place on Golgotha, is the reflection of superterrestrial events and of the relationship between the worlds of the gods connected with Saturn, Sun, Moon and the present Earth, and Ahriman. The cross of Golgotha cannot be looked upon as something earthly, but as something having a meaning for the entire universe - this was the content of esoteric Christianity.

"We must learn to fathom what the Christ himself taught to his initiated disciples after his resurrection, and we must take for granted that he could impart such teachings only after having passed through an experience, here on earth, which he could not have had in the divine world - for until the Mystery of Golgotha death did not exist in the divine worlds. No being of the divine worlds had passed through death - Christ is the first-born who passed through death from the world of the hierarchies, connected with the evolution of the Earth that went through Saturn, Sun and Moon.

"The secret of Golgotha is the inclusion of death into life. Before Golgotha, the knowledge of life did not include death."

Thus, it is a basic tenant of anthroposophic esoteric christianity that both the Cosmic Christ and Jesus of Nazareth suffered death on the cross. Otherwise the Islamic principle of Doceticism is valid and Jesus was just another Avatara or True Prophet.

Now the problem arises when one tries to reconcile this basic tenant with other lectures of Dr. Steiner, notably, those of the GOSPEL OF ST. MARK (1912) and BACKGROUND TO THE GOSPEL OF ST. MARK (1910). In Mark 14:51 we read "and a youth was among His followers who wore a linen cloth about his body; and they seized him, but he left the linen cloth and fled naked."

Now Dr. Steiner in his GSM 23 sept. 1912 says,

"Who was this youth? Who was it who escaped here? Who is it that appears next to Christ Jesus nearly unclothed, and then slips away unclothed? This is the youthful cosmic impulse, it is the Christ who slips away, who now only has a loose connection with the Son of Man...It is the entirely naked, new cosmic impulse of earth evolution."

And later Steiner relates that the youth found in the tomb (Mark 16:1-6) after the resurrection of Jesus was,

"Also this same youth, ...the youth who slips away from the people at the moment when they condemn the Son of Man, who is there again when the three days are over, and from now onward is active as the cosmic principle of the earth."

Therefore, we have two Jesus beings, one is called Jesus of Nazareth, the Son of Man and the other is called the Cosmic Christ, the being who is the "new cosmic impulse of earth evolution." However, how are we to see the historical event of the death of a god on the cross, the basic tenant of esoteric christianity, if in fact, the Cosmic Christ abandoned the Son of Man on the cross in the spirit form of the fleeing naked youth, prior to the crucifixion? As Oskar Kurten said in his article THE SON OF MAN AND THE COSMIC CHRIST,

"how then are we to understand the Cosmic Christ?...Christ could not possibly have separated from Jesus in Gethsemane but remained united with him even beyond death...it would be a complete contradiction to everything Steiner says concerning the Mystery of Golgotha, if we were to conclude that it had been only the human being, Jesus of Nazareth, who as the Son of Man, suffered death on the cross."

Kurten proposes a strictly Steiner like solution to the dilemma by separating out from the Son of Man those higher spiritual forces of the Cosmic Christ, which withdrew from Christ Jesus on the cross, in the image of the fleeing youth. However, he wrongly concludes that these higher forces of the Cosmic Christ, after death, reunite with the risen Christ to "live in their triune oneness as the spirit of the earth in human souls ON EARTH." There is no cosmic merger of the three separate microcosmic and macrocosmic principles (manas, buddhi and atma) of the Christ being living in or on the earth. Only the macrocosmic ego of the Cosmic Christ lives in the earth, or on the earth. The other higher spiritual forces to which Dr. Steiner referred actually live outside the earth and on the sun, which is a matter to be taken up later.

The bible scholar, Edward Smith, also proposes a solution in his book THE DISCIPLE WHOM JESUS LOVED. Here he says that the fleeing naked youth is in fact the risen Lazarus-John person, in whom those higher spiritual forces of the Cosmic Christ, have united. And it was also the risen Lazarus-John who appeared in the tomb after the resurrection. This certainly is a plausible explanation considering that Lazarus not only experienced a personal initiation by Jesus, but was actually raised from the dead, creating possibilities for higher than normal angels to incarnate in him. However, Lazarus can only be considered a temporary carrier of these higher principles until the time of the resurrection, at which time these were disbursed into the etheric and astral spheres surrounding the earth.. For me the solution comes from an evaluation of the correspondences of the macrocosmic principles of the Cosmic Christ and the microcosmic principles of Jesus Christ, the Son of Man.

THE SON OF GOD and the SON OF MAN

Ever wonder why our personal memory only extends back to a certain age in early childhood?

Maybe 3 or 4 years old. My parents told me that I rode a 20 inch bicycle and age 2 and 3. Later, when I was 4 or 5 I got a new bike and I couldn't ride it, I had to learn to ride it all over again with training wheels. Why shouldn't riding a bike be like swimming, that once learned, never forgotten? Was it because I was two different persons, and had no link between the two?

In a very real sense, we are two different persons living two very different stages of life. The first person and age is from birth to the emergence of our personal ego at which time our personal memory begins. I look back at these first 2 or 3 years as my age of 'cosmic memory.' During life I have a feeling about certain things that I know occurred during these years but, I have no memory recollection of the events. For example, when in my local church, I frequently think of seeing angels during mass, something that I know happened in my early years, but have no memory of it. Likewise, my cosmic memory tells me that as a child, when sitting alone in the bathtub, I had lots of little friends there, with me. That's why I carried on the practice later in childhood of having little plastic men to play with in the tub.

Then there is a 'crossing over' that occurs between the cosmic memory and the emergence of the personal ego at age 3 or 4. From that time onwards, the cosmic memory is forever lost and our ego self-consciousness begins. This second person and second age of life lasts until death. Our personal life memories extend back only to the beginning of this second life.

In that most remarkable of little books, THE SPIRITUAL GUIDANCE OF HUMANITY, Dr. Steiner describes how the infant for up to three years is lead by the forces of higher angels. In a microcosmic recapitulation and reflection of the three sacrifices of the pre-incarnated Christ, these spiritual angels teach the infant, first to stand up and walk, to orient itself in space. Second, to learn how to speak, in the Noam Chomsky sense, to learn language. And third, to think with human reason. The capacities to stand up, speak and think are not hereditary, but come out of ourselves. But what goes into the infant as influences come from the higher spirits. As Steiner says,

"once we are no longer soft and malleable as children, we can no longer stand to have the forces of the spiritual world continue to affect us directly...higher forces that have a

decisive influence on us in childhood can work on us for THREE YEARS....if we could somehow remove the I from a person...and replace it with an I that is connected with the spiritual worlds, after three years this persons body would fall apart. "

After these three years, these higher forces give way to the incoming ego consciousness and our personal memory begins our cosmic memory fades into the subconscious. So we may say there are two distinct periods in a human life, the first three years when the child is lead thru physical development and the remaining years of lifetime. In the microcosmic man, we may refer to these two stages as the son of god and the son of man.

What are these "higher forces" that lead the child's life for three years and are so powerful, that if they didn't leave, the physical body would be destroyed?? Steiner is very non-committal about naming them, but he leaves a few telling hints. He says that "what lives within us (in childhood) is truly a higher, divine human being and we can feel ourselves pervaded by this being as by a living presence of whom we can say THIS IS MY INNER GUIDE...this higher I is connected to the spiritual hierarchies...and has been there all along." The spiritual hierarchies to which Steiner refers are those of the Archons, Archangels and Angels, working in us as the higher principles of atma, buddhi and manas. In one sense, we can say that at birth our microcosmic atma unfolds, guiding the development of the fetus thru ontogeny. After birth, our personal buddhi and manas unfold during the life of the cosmic memory until the birth of the personal ego. At the same time, our mother's hereditary etheric and astral bodies sheath our personal ego, until, at second teeth, our personal etheric body forms and later at puberty, our personal astral body forms. It is the presence of these three higher angelic hierarchies that guide our embryonic and early childhood development that can only last a few short years and must leave actively working in the physical body. After their withdrawal, they still continue to work in us, inactively however, only during sleep throughout the remainder of our adult life..

This higher I, this inner guide is of course our personal buddhi principle working unconsciously in us during early childhood. As such, it is directly connected to the higher archangelic hierarchies. It has to leave the body when our personal ego arrives because we have not evolved far enough to let the higher I live within us for an entire lifetime. We can only experience glimpses of it. This higher I, when properly developed, will also become our Christ within us. In the microcosm, Christ is the buddhi spirit of humanity. As our personal ego evolves unselfish love, we replace our personal I with the higher I of Christ, not my ego, but the Christ within me. That is why Steiner said "to know the forces at work in childhood is to know the Christ within us."

Dr. Steiner further describes these two periods in the life of a man in BGSM ch. six as follows:

" Two periods of development, each very different from the other, are apparent in man's life between birth and death in every incarnation. One of these periods lies between birth and the point at which an individual's memory begins. Just think how much is taken in during the first three years of life; yet modern man has no remembrance at all of how the impressions were made. It is only at the point from which memories begin that he gradually detaches himself from his environment as an independent being. "

In the Pauline sense, this first period is called the "Son of God." The second period, from after the beginning of memory until the end of life, is called the "Son of Man." Dr. Steiner says "This is the spirit which in Pauline christianity is called 'the Son of Man'. Here is a concept which you must grasp-the concept of the Son of Man, who can be found in a human being onwards from the point in his life to which his later memory extends, and includes everything he has acquired from the civilization around him." We may think of the life of the Jesus of Nazareth from age 12 to the incarnation at age 30 as His period of the Son of Man.

In the incarnation of Christ we also see the same correspondence. The indwelling Cosmic Christ spirit could only live in the physical body of Nathan Jesus also for three years. This is His period of the Son of God. In the same sense that in the microcosm for human childhood, there lived a higher spirit which guides the infancy of a child, so too in the macrocosmic life of Christ, there lived for three years, a higher spirit that guided His life. That higher spirit was THE FATHER.

In the same sense that the buddhi spirit lives in the child for three years and then departs, so too the Father spirit lived in Jesus for three years and finally departed during the agony on the cross. And, in Christ, the Son of God merged with the Son of Man, in reverse order. The Father forces incarnated during the baptism lived along side and in union with the other macrocosmic principles of manas and buddhi. But for the Cosmic Christ, his buddhi was the Father living in Him for three years, hence the saying " I and the Father are one." For us as humans, our higher I or higher ego is the Christ. For Christ, His higher ego or buddhi, was the Father within him.

In a very real sense, what caused the destruction of the physical body of Jesus of Nazareth was the supreme forces of the Father living in the Son of Man. Steiner says here, "In the normal man of today these two forms of consciousness are separate: indeed they must be separate, for they are incompatible. Nor were they any more compatible in Christ Jesus himself; after those three years, death was bound to supervene. ...These circumstances...came about because these two lived within each other....the living together of the Son of God and the Son of Man"

However, slowly, slowly, the Son of Man and the Son of God separated. Dr. Steiner remarked in his GSMK lectures that " toward the end of His life Jesus of Nazareth was more and more alone, and the Christ became ever more loosely connected with Him. Although the cosmic element was there until the moment pictured as that of the sweating of blood in Gethsemane and Christ at this moment was fully united with Jesus of Nazareth, now through the failure of human beings to understand this connection, the link was loosened." It was during this sweating of the blood, that the cosmic Christ ego, fully penetrated His physical body, causing the phantom body to arise as the "new Adam." This link slowly slipped away as the troops of Caiaphas drew near and touched Jesus and bound Him with ropes. Finally, the 'cosmic element' fully departed in the naked fleeing youth. But Steiner makes it clear that these cosmic forces still continued to "hover around Him " and they later returned to the tomb after the resurrection. After the departure of the naked fleeing youth Steiner remarks that "all that was left was the Son of Man." This was a strong statement and does not really reflect the whole picture, that still within the Son of Man was the macrocosmic Ego of the Father. Steiner uses several different terms for the cosmic qualities of his Cosmic Christ. One is the "youthful cosmic element" and another is just the "cosmic element". He lumps together the macrocosmic elements of the ego, manas and buddhi of the Cosmic Christ together with the "youthful cosmic impulse" of the Father. If we take them separately, one element being the twofold macrocosmic manas and buddhi principles of the Cosmic Christ and the other element being the single macrocosmic ego described by Steiner as the 'youthful cosmic element' of the Father, I think we can distinguish a different picture.

Although the two-fold principles of the Cosmic Christ departed in the figure of the fleeing naked youth, the forces of the Father, as working into the macrocosmic ego, never left Christ Jesus until the death on the cross. The sixth saying from the cross "MY God, My God, why has thou forsaken Me?" is a symbol for the ego of Christ lamenting the departure of the Father spirit in him just before the instant of physical death.

Even though I said (above) that Christ's buddhi was the Father active in Him, and that Christ's buddhi left in the figure of the fleeing youth, this does not necessarily mean that the Father as buddhi departed and did not stay with the Son of Man until the final moment of death on the cross. For the human, the relationship between the ego and the buddhi principal is that of the *likeness* to the *image*, the personal ego to the higher ego. Buddhi, the archetypal *image* of the celestial/sidereal ego, rays into the personal ego and as it develops, it transforms the etheric body, opening the seven etheric chakras. But in man, this transformation has never been carried to perfection. This is the work of the *New Adam* of St. Paul.

In Christ, by contrast, the forces of the Father as buddhi, during the 3 ½ years, transformed His etheric body until perfection was achieved in the "phantom body" of the resurrection. This work of the *New Adam* was for the first time completed during the sweating of the blood during the night in Gethsemane. At this moment in time, the microcosmic atma, worked over by the cosmic ego during the 3 ½ years, united with the physical body of the Son of Man. Then, as Dr. Steiner says, the thread between the cosmic ego of Christ and the Cosmic buddhi of the Father was loosened until they finally separated in the figure of the naked fleeing youth. The difference is that in man, complete perfection is never achieved, whereas in Christ, perfection was achieved down into the physical body so far as microcosmic atma (the Macrocosmic Atma being left on the sun). The proof of the *New Adam* being the perfect etheric body, the "phantom body" of the resurrected Christ. After the sweating of the blood in Gethsemane, the Father forces could depart, after having transformed the ego of the Christ and the work of the new creation having been achieved.

In the microcosm, Christ is the buddhi force active in humanity as Higher Ego, transforming the lower ego thru love and community. In the macrocosm, the Father acted as the buddhi force active within the Christ Jesus as the "youthful impulse" described by Dr. Steiner. But the youthful forces of the Father acted throughout all of the principles of the Cosmic Christ, worked upwards into His manas and buddhi, and downwards into His astral and etheric bodies, right down deeply into the physical body as microcosmic atma. So when the cosmic principles of manas and buddhi left the Son of Man in the figure of the naked fleeing youth, the forces of the Father still remained in the macrocosmic ego of the Son of Man. The Son of Man was alone and cut off from His manas and buddhi, but was still in the living grace of the Father active in His ego.

Otherwise, what could have possibly kept alive the Son of Man during the incredible tortures of the passion? No human being, nor the Son of Man himself, could have survived the scourging, the crown of thorns, the beating of the guards, the carrying of the cross and the nailing to the cross. Only the forces of the Father still active in Jesus could

have taken the Son of Man from Gethsemane to the hill of Golgotha. The sixth saying from the cross "MY God, My God, why has thou forsaken Me?" truly is a symbol for the ego of Christ lamenting the departure of the Father spirit in him just before the instant of physical death.

When the Father spirit finally left the physical body of Christ, these cosmic forces too, still continued to "hover around Him " and they later returned to the tomb after the resurrection. It is here that Oskar Kurten makes his error. For him, these higher forces of the Cosmic Christ that return to the tomb, reunite with the risen Christ to "live in their triune oneness as the spirit of the earth in human souls ON EARTH." However, as we have described, only the Macrocosmic ego of the risen Christ remained on earth. His other forces of manas, buddhi and atma live in the earth's atmosphere and on the sun. These are gifts to the future mankind as now explained.

CHRIST DIED TO THE SUN

In the lecture series KARMIC RELATIONSHIPS Vol. VIII, Steiner says,

" Christ dies to the sun...He went forth from the sun as we human beings go forth from the earth when we die...after His cosmic death, Christ left His Spirit-Man (atma) on the sun and around the earth, His Life-Spirit (buddhi). So that after the mystery of Golgotha the earth was swathed as it were by the Life-Spirit of the Christ....and bringing down His ego and His spirit-self (manas) to the earth "

This is how to think of it. We humans DIE TO THE EARTH and GO TO THE SUN. When we die, we leave our physical body here on earth, our etheric body disperses into the atmosphere and our astral body crosses the first threshold into purgatory, the moon sphere. After our penance there, we leave our astral shell in purgatory and then cross the second threshold on into the sun sphere, for lower and higher heaven devachan. Thus, our personal ego joins our spiritual trinity of manas, buddhi and atma to sojourn in the spiritual worlds of the sun and slightly beyond until the moment of cosmic midnight, when we then retrace our path thru the spheres downwards back to incarnate again on earth. Thus, after death we basically travel from the earth, to the moon and to the sun and return again for our next incarnation.

For the Cosmic Christ, the process was just the reverse, for He DIED TO THE SUN and WENT TO THE EARTH. The Cosmic Christ, as a macrocosmic being, also has His higher principles of atma, buddhi and manas. When He left the sun sphere to incarnate in the Son of Man during the baptism, He died to the sun, as we die to the earth, but instead of leaving his physical body, as we do here on earth, He left His ATMA, on the sun.

Because of this occult fact, it was not the MACROcosmic atma of the Son of God that penetrated the physical body down to the bones during the sweating of blood in Gethsemane, but His MICROcosmic atma, into which the Forces of the Father had worked thru the macrocosmic ego of the Cosmic Christ. Dr. Steiner had said many times that the forces of the Cosmic Christ FULLY PENETRATED the physical body of Christ Jesus, the final and deepest penetration coming during the sweating of blood during the agony in the Garden of Gethsemane, at a time when the Son of God and the Son of Man were still fully united. But this must only be understood to mean the microcosmic atma that penetrated, since the macrocosmic atma forces had been left in the sun sphere.

Was this microcosmic penetration sufficient to accomplish the goal of a creating the etheric Phantom Body of a *New Adam*? Yes, because the penetration occurred when the Father forces of the Son of God were united in the Son of Man. Even though the forces of the Son of God later departed in the fleeting naked youth, the atmic act was consecrated in the sweating of the blood.

The active Father forces, working thru the macrocosmic ego of the Son of God, replaced the atma of the Son of Man, to accomplish the same deed. It was in effect a replacement between the forces of the Father for the abandoned atma forces of Christ Jesus, left on the sun for the future development of humanity. It can be better understood in relation to the future of humanity, when the macrocosmic atma of the Cosmic Christ will be used for the other purposes of: (1) the resurrection of the dead at the end of this manvantara cycle during the reunification of the earth planet into the sun and (2) the reunification of the sun and earth at the end of the Vulcan manvantara. (which purpose will be discussed later)

The other principles of the Cosmic Christ were dispersed as follows. After the death of the Son of Man on the cross, the macrocosmic ego of the Cosmic Christ, DIED TO THE EARTH, and became part of the earth's interior, the earth as Holy Grail chalice. The macrocosmic MANAS of the Cosmic Christ, was left in the earth's atmosphere as the Fifth Gospel, LEFT TO THE FUTURE OF MANKIND, as the imaginations of the Cosmic Christ. The macrocosmic BUDDHI of the Cosmic Christ, was also left above the earth's atmosphere, LEFT TO THE FUTURE OF MANKIND, as the sphere of the returning Etheric Christ.

Now simply said, the fleeing naked youth is a symbol for the higher spiritual principles of the Cosmic Christ, the macrocosmic manas and buddhi, which were left in the earth's atmosphere for the future use of mankind. (And not united in some triune oneness as described by Mr. Kurten)

In our first conclusion, we have the four higher cosmic principles of the Cosmic Christ as follows:

7. atma, in the sun;
6. buddhi, in the atmosphere surrounding the earth;
5. manas, on earth, but in a surrounding sphere, above earth; and
4. MACrocosmic ego, in earth, forever united with the planetary evolution of earth, as the Holy Grail.

THE MACROCOSMIC EGO of the COSMIC CHRIST

However, it is important to understand the difference between the Microcosmic and Macrocosmic principles in the Cosmic Christ. Hopefully, this is not some pinhead exercise in modern scholasticism. In the above scheme, only no. 4, the Ego of Christ is Macrocosmic as to humanity and this solar system. The manas, buddhi and atma of the Cosmic Christ are microcosmic. Dr. Steiner explains this difference in his lecture *the COSMIC EGO AND HUMAN EGO* (9 Jan 1912),

"The Christ is quite radically different from other beings who share in earth evolution. The Christ was not directly connected with earth evolution, but with the sun evolution. He is a being who remained behind, not only during Moon evolution, but also during the Old Sun evolution. His evolutionary conditions were such that this macrocosmic Christ being evolved the macrocosmic ego outside earthly conditions. He was a macrocosmic being from the beginning of earth evolution, on. The Christ, then, is a four membered being, including His macrocosmic ego, just as man himself is microcosmically a four membered being."

In the same vein, Dr Steiner in his lecture of 18 Nov 1911 reprinted in the book *ESOTERIC CHRISTIANITY AND THE MISSION OF CHRISTIAN ROSENCRUTZ* says,

"Since the Saturn stage, throughout the Sun and Moon stage, man has developed his physical, etheric and astral bodies. The ego could only appear on earth in a body that was sufficiently prepared for it and then develop further under the nurturing influence of the Christ impulse because Christ is macrocosmically what our ego is to us microcosmically...Christ is a macrocosmic being at the fourth stage of His macrocosmic development, as man is microcosmically at the fourth stage. So you should keep macrocosmic and microcosmic principles apart, but be clear about the fact that the first four macrocosmic principles include of course all the higher microcosmic principles."

As a human, our ego principle was a gift poured out from the cosmos by the Holy Spirit and the Spirits of Form. The sphere of the ego descended during the middle of the Atlantean Age and since that time, humans have absorbed from it their microcosmic ego, which over time has now become hereditary as the ego is now implanted during fetus development. However, as a microcosmic principle, the destiny of our human ego is limited to the existence of this Fourth Earth manvantara. Although we may be able to partially evolve the higher principles of manas, buddhi and atma during earth evolution, the evolution of these higher principles depend on Luciferic beings, which are only microcosmic in development. These higher principles are in a sense only grafted unto humans.

Even Anthroposophists find this difficult to understand, because in effect, the Cosmic Christ as presently membered is a lower spiritual being than say, Lucifer. Because the luciferic beings have as a whole already developed their fifth manas principle and some have partially developed their sixth and seventh principles, they stand higher than man and higher, in this respect, than the Christ. Dr. Steiner says that this is the basis for the position of the anti-christ against the Christ in the future of humanity, because, the anti-christ will have more fully developed its higher principles. However, these luciferic beings have only developed these higher principles MICrocosmically, whereas the Christ has developed His ego MACrocosmically, which is infinitely more important than all microcosmic principles combined.

Another problem that Anthroposophists have is Dr. Steiner's statement that as presently membered, "the Christ is a macrocosmic being at the fourth stage of His macrocosmic development." I really have never met any anthropop who really understands what this means, cosmically. Most anthropops say that because He is the world creator

Logos of the beginning of the John gospel, that He is a fully developed twelve membered being and has always been such. But this certainly is not the case.

Dr. Steiner goes further in his description of the principles of the cosmic Christ in this lecture (above) of the 9 Jan. 1912 as follows.

"The Christ being is a being who in a certain sense is like the human being, only that man is microcosmic and has brought his four principles to expression microcosmically, and hence has his ego also microcosmically as earth-ego-but the Christ as cosmic Ego. His evolution was such that He was great and significant because the perfect development of this ego, which He brought down to earth. And he had not the fifth macrocosmic principle, and not the sixth, for HE WILL EVOLVE THESE ON JUPITER AND VENUS, IN ORDER THAT HE MAY GIVE THEM TO MAN. Now each macrocosmic principle has an inner relationship to the corresponding microcosmic principle; the fourth macrocosmic principle in the Christ corresponds to the fourth microcosmic principle in man, and the fifth in the Christ will correspond to the Spirit-Self in man."

What this means is that the Christ is not a fully developed cosmic being, but more structured as follows in our second conclusion;

7. Microcosmic atma, in the sun sphere;

6. Microcosmic buddhi, in the atmosphere surrounding the earth;

5. Microcosmic manas, on earth, but in a surrounding sphere, above earth; and

4. MACrocosmic ego, in earth, forever united with the planetary evolution of earth, as the Holy Grail.

The spheres of our microscopic manas, buddhi and atma are the spheres of imaginations of beings that lived thru the Old Moon manvantara. The record of their thoughts, feeling and will were preserved and passed on and over to the Earth manvantara during the recapitulations of Saturn, Sun and Moon. Preserved as cosmic imaginations for our Earth evolution, they become our higher spheres of imagination, inspiration and intuition, to which we ascend after we complete our cycle of self-consciousness during the evolution of our sentient soul, mind soul and consciousness soul. However, as great as these gifts are, they are still only microcosmic in nature, they are gifts from partially evolved microcosmic beings as are ourselves.

When the Cosmic Christ gave up His macrocosmic ego to mankind during His death on the cross of Golgotha, He gave us a chance to participate in His ego, which will last throughout the entire planetary manvantaras of Jupiter, Venus and Vulcan. As the Cosmic Christ is a macrocosmic being at His fourth (ego) stage of His macrocosmic evolution, so is man at his fourth-ego-stage of his microcosmic evolution. However, to the extent that we absorb His cosmic ego within us, so we also participate in His macrocosmic evolution.

What this means is that Christ will come again to us during the Jupiter manvantara wherein He will develop His fifth macrocosmic principle. Like wise, Christ will come again during the Venus manvantara wherein He will develop His sixth macrocosmic principle and so into the last seventh Vulcan manvantara, wherein His atma, preserved on the sun, will also be given to mankind. Thus, during the Jupiter manvantara, the macrocosmic Manas principle of the Cosmic Christ will also be given to humanity in the same sense that His macrocosmic ego was given to mankind during His death on the cross. And, during the Venus manvantara, the macrocosmic Buddhi principle of the Cosmic Christ will also be given to humanity. And during the Vulcan manvantara, the macrocosmic Atma will be given to the earth and humanity for that transition of the earth into a new sun. In each manvantara, the Cosmic Christ retrieves his microcosmic manas, buddhi and atma, left behind in the earth and sun spheres and transforms them, into macrocosmic principles, for the benefit of humanity. And as humans, during our future evolutions, we participate in His cosmic evolution to the extent that we take the Christ impulse within us. As Dr. Steiner said (above) " Thus the Christ being is a being who in a certain sense is like a human being...He had not the fifth macrocosmic principle and not the sixth, for He will evolve these on Jupiter and on Venus, in order THAT HE MAY GIVE THEM TO MAN."

Finally, we can see how the fully developed Cosmic Christ will evolve with us over the next three manvantaras as follows:

7. MACrocosmic atma, to be achieved during Vulcan evolution.

6. MACrocosmic buddhi, to be achieved during Venus evolution;

5. MACrocosmic manas, to be achieved during Jupiter evolution;

4. MACrocosmic ego, achieved during Earth evolution.

Thus, mankind evolves its higher principles in union with the Cosmic Christ. At the beginning of each new manvantara, all levels of being go up a notch. At the present time, The Cosmic Christ is membered as a nine-fold cosmic being, who will become 10 fold during the Jupiter manvantara, 11 fold during the Venus manvantara and finally, a fully developed twelve-fold being during the Vulcan manvantara. At this future time, the 12 fold-ness of the Cosmic Christ will reach up to the constellation of Aries, the Mystical Lamb.

In a lecture of 28 Oct 1923 Dr. Steiner said, "in the pineal gland, the optic thalamus secretes out of itself the so-called brain sand, the mineral element of the head....It is actually in this mineral deposit that the spirit-man (atma) is anchored; and this immediately shows that what is living cannot harbour the spirit, but that the spirit in man needs something non-living as its center, which means that above all else it must be a spirit with independent life."

Likewise, it is in the mineral deposit of gold forming a non-living center of the earth to which is anchored the atma of Christ that He left on the sun. In the last Vulcan manvantara, the spiritual alchemy of the earth's gold and the Christ's atma will join to transform the earth into the new sun of the next cycle of planetary evolution.

28 jan 02

THE SEPHIR YETZIRAH

1. The Source in Abraham

The most comprehensive way to summarize the Laws of 3, 12 and 22 is by correspondence to the Sephir Yetzirah, the oldest text of occult Kabbalist Hebrew wisdom.

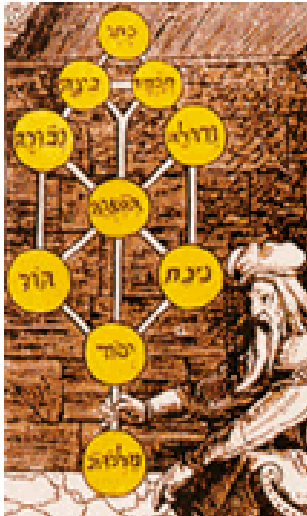

The source of the text is attributed to the founding father, Abraham, which of course, extends back to the beginning of the Hebrew sub-race. But what were Abraham's sources? There would seem to be only two possible sources. The first source could have been the ancient Chaldean wisdom of Babylonia. We know from the Bible, that Abraham came to Canaan from Ur in Chaldea. Thus, the text of the S.Y. could have originated in the ancient wisdom of the Chaldean initiates of the mystery center existent there.

The other source could arise after Abraham arrived in Canaan and met the high priest Melchizedek in Salem. Who was this strange figure described in Hebrews as,

"For this Melchizedek, King of Salem, priest of the most high God, met Abraham returning from the slaughter of the Kings and blessed him. He is first, by translation of his name, King of Righteousness, and then also King of Salem, that is King of Peace. He is without father or mother or genealogy, and has neither beginning of days nor end of life, but resembling the Son of God he continues a priest forever."

The Letter to the Hebrews is a New Testament book found in the Dead Sea Scrolls located in Qumran labeled 11 Qmelchizedek, which clearly gives eternal life to this priest to whose order the "Son of God", Jesus belonged.

As revealed in the Dead Sea Scrolls, the Essene monks recognized Melchizedek as the heavenly high priest who guided the incarnation of Christ through the genealogy of Abraham to the birth in Bethlehem. This spiritual connection is exoterically described in Genesis in the giving of bread and wine to Abraham and later realized in the giving of bread and wine at the Last Supper by Christ to his Apostles.

The highest regard given to Melchizedek by the Essenes absolutely confirms the spiritual research of R. Steiner who says that "Malek-Zadek" was the occult name of this priest of the great oracle center presumably located in the volcanic rift of Jerusalem known as the Tyropoeon valley. As described in Occult Science, the evolution of the seven root races during the Atlantean epoch was guided by initiates through seven mystery centers or oracles. Thus, on the one line of evolution and oracle wisdom stood the Saturn, Jupiter and Mars initiates. On the other side stood

the Venus, Mercury and Vulcan initiates and in the middle were the sun or Christ initiates. At seven different locations on our planet were the seven mystery oracles guarded by the initiates. When the Atlantis civilization was destroyed, the great sun oracle initiate led a new colony of survivors from the West (Ireland) to the East (Indus Valley) and re-established the seven mystery-oracle centers to guide humanity through the post-Atlantean epoch. The seven Rishis were the first teachers of the first Hindu cultural epoch initiated by this great sun-oracle leader named Manu. Later, Zarathustra was initiated as the leading spiritual force of the second cultural epoch. Hermes was the leader of the third cultural epoch arising in the Egyptian-Chaldean peoples. The Semites were a sub-race of the fourth Greek-Roman cultural epoch. Abraham was the progenitor of this sub-race and Malak-Zadek was his occult teacher. Melchi-Zadek or King Zadek takes his title from the Hebrew name for the residing spirit of the planet Jupiter-ZADEK. Thus, Malek-Zadek was the leader of the Jupiter race and the Jupiter oracle.

Thus, we see that the meeting between Melchizedek and Abraham at Salem was esoterically an initiation into the Jupiter oracle center by Abraham which resulted in, among other things, the source of the text of the S.Y.

The key to the mission of Abraham is described in the S.Y. as "the Lord most high revealed himself.. and made a covenant with him (Abraham) and his seed". Now the seed of Abraham grew into two branches. The first was the Hebrew nation derived through his son Isaac with his wife Sarah. The second was the Arab nation derived through his son Ishmael with his Egyptian wife Hagar. The task of the Hebrew people was also twofold. First, through the genealogy of blood, the Hebrew people prepared the physical, etheric and astral bodies through the three times fourteen generations described in the beginning of the St. Matthew gospel to serve as a perfect crucible in which to receive the ego of the Christ at the baptism at the Jordan.

The second task was to prepare the mind to recognize the significance of the Christ event for future humanity. The great sun initiate Malek-Zadek gave genetically to Abraham's brain an organ to observe the phenomena of the external physical world and to relate these sense impressions into number, measure and weight. Thus, Abraham is the father of constructive reasoning and mathematical logic which is clearly evident in the Semitic sub-race of the Hebrews. This genetic change evident in the Hebrew descendants of Abraham was accomplished by a merging of the etheric body closely with the physical head which transformed a portion of the physical brain into the actual organ of thought.

In other sub-races living at the time of Abraham, the physical and etheric bodies were more separated in varying degrees which resulted in the Atavistic clairvoyance in the brain and unlimited ancestral memory in the etheric body. The old ancestral consciousness was symbolically represented by the snake and the newly propagating mathematical consciousness was represented by the two horns of the lamb. The later is graphically represented by Michelangelo's portrait of Moses with two horns protruding from his forehead (the so-called two-petalled lotus). Here is the fountain source of the gift from Melchizedek to Abraham, the S.Y. is the occult text of the cosmology of the universe written according to number, measure and weight as reflected through the Laws of 3, 7 and 12.

2. The Hebrew Alphabet as Logos

The text of the S.Y. divides the 22 letters of the Hebrew alphabet into three sections, the first as:

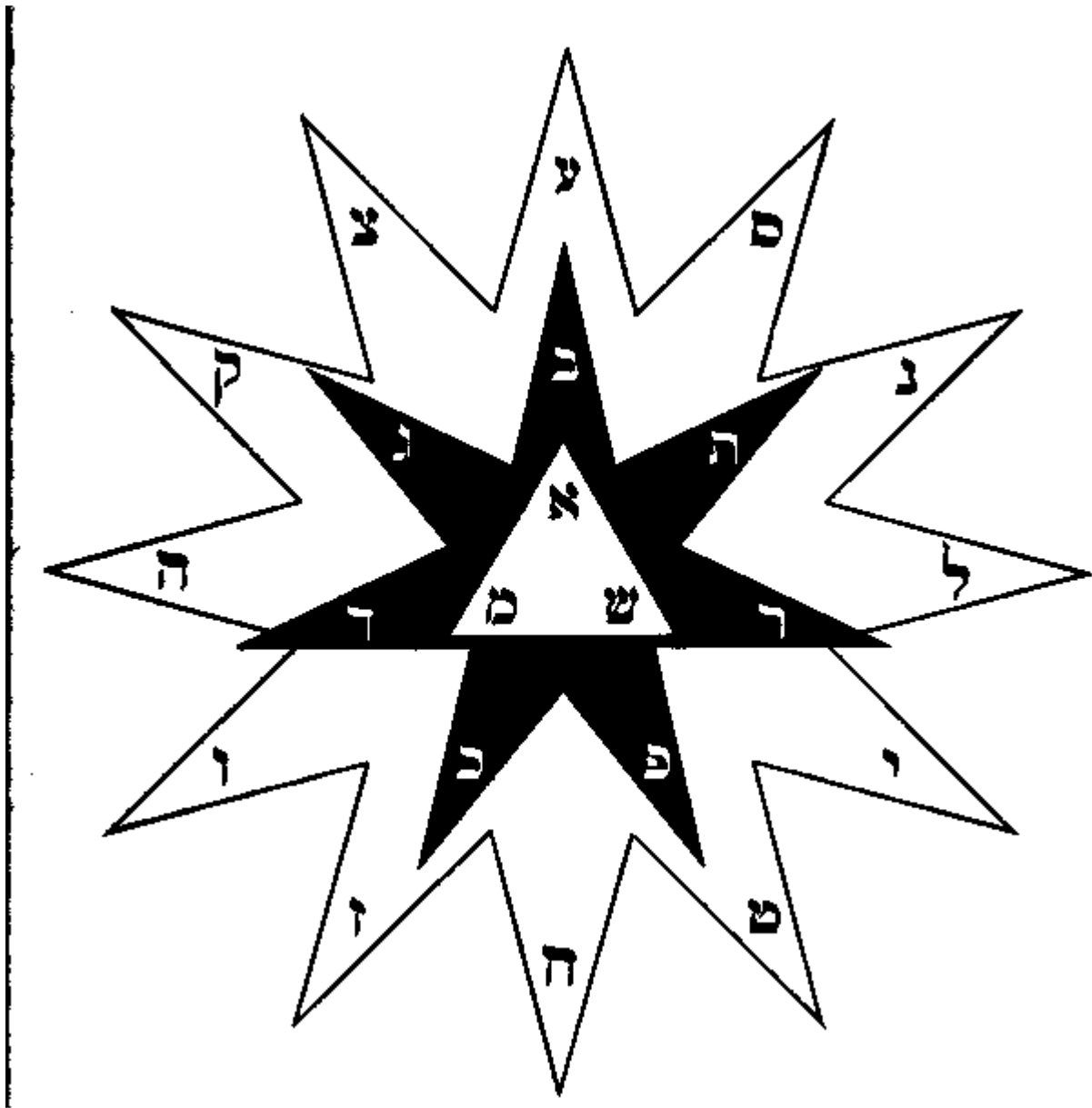

"The three mothers Aleph, Mem & Shin are a great mystery... and from them proceed air, fire and water, which divide into male and female forces...and from them have proceeded all things that are in the world." This of course recognizes the primary law of three, as reflected in the three mother letters, as the moving forces which create the cosmos. As discussed in Chapter One, 3., the Law of Three represents the unmanifest trinity of forces active, passive and neutralizing.

The letter aleph is an aspirate, pronounced with a silent breathing and for this reason correlates to the primordial substance air. The letter mem is a mute produced by the pressing together of the lips. The fish is the silent resident of water and for this reason, this letter correlates to the primordial element water. The letter shin is a sibilant and pronounced with a hissing sound and for this reason correlates to the primordial element of fire.

Additional correspondences are described in the S.Y. as follows:

	SHIN	ALEPH	MEM
Microcosm	Primal fire	Spirit air	Water
Universe	Heavens	Atmosphere	Earth
Elements	Terrestrial Fire	Air	Water, Earth
Man	Head	Chest	Stomach

Season	Heat (summer)	Temperate	Cold (winter)
"The seven double letters beth (B), gimel (G), daledh (D), Kaph (K), pe (P), resh (R), and tau (T,TH)... are called double, because each letter represents a contrast or permutation...and He (Jehovah) preferred the number seven above all things under Heaven."			

This, of course, recognizes the Law of Seven as the maker of the manifest world, in duality or double letters. Thus, the S.Y. describes the manifest world of the 7 planets, the 7 Heavens, the 7 earths, 7 Sabbaths, 7 days of creation, 7 gateways of the soul of man (7 orifices), 7 days of the week and every 7th year a jubilee. In addition, the text recognizes the 7 directions of space as north, south, east, west, above, below and the holy palace in the center of them. This corresponds to our hidden cube within the Tetractys on page 51, herein. Additional correspondences are described in the S.Y. as follows from each of the seven days in the week.

1. Beth	Wisdom	moon	right eye
2. Gimel	Health	mars	right ear
3. Daleth	Fertility	venus	right nose
4. Kaph	Life	sun	left eye
5. Pe	Power	mercury	left ear
6. Resh	Peace	saturn	left nose
7. Tau	Beauty	jupiter	mouth

"The twelve simple letters are heh, vau, zain, cheth, teth, yod, lamed, nun, samech, oin, tzaddi and qoph...they are the foundations of these 12 properties, sight, hearing, smell, speech, taste, sexual love, work, movement, anger, mirth, imagination and sleep... and formed with them the 12 celestial constellations of the zodiac."

This, of course, recognizes the Law of Twelve in the macrocosm (zodiac) and the microcosm (man). In addition, the S.Y. describes 12 directions in space as the "arms of the universe" which corresponds to our 12 degrees of freedom on page 89. Additional correspondences are described in the text as follows:

1. He	Aries	march	right foot
2. Vau	Taurus	april	right kidney
3. Zain	Gemini	may	left foot
4. Cheth	Cancer	june	right hand
5. Teth	Leo	july	left kidney
6. Yod	Virgo	august	left hand
7. Laured	Libra	september	sex organs
8. Nun	Scorpio	october	intestines
9. Samech	Sagittarius	november	stomach
10. Oin	Capricorn	december	liver
11. Tzaddi	Aquarius	january	gullet
12. Qoph	Pisces	february	spleen

Thus, we see that the S. Y. establishes the Hebrew alphabet as the Logos and the instrument of creation in itself. It also establishes for the first time, the concept of the unmanifest trinity in the words, "the three are one and that one stands above". It establishes the manifest world of seven in the words, "the seven are divided, three are over against three and one stands between the triads." And finally, it establishes the microcosm and macrocosm of man in the universe expressed by the Law of Twelve. The laws of the triad, Heptad and dodecad are shown in Plat of 22 letters .

3. The 231 Gates

A greater mystery of the S.Y. is that of the 231 gates. In Chapter II it is revealed,

4. These 22 letters, which are the foundation of all things, He arranged as upon a sphere with 231 gates, and the sphere may be rotated forward or backward, whether for good or for evil, from the good comes true pleasure, from evil, nought but torment.









5. For He shewed the combination of these letters, each with the other; Aleph with all and all with Aleph; Beth with all, and all with Beth. Thus, in combining all together in pairs are produced 231 gates of knowledge.

What are the 231 gates?

Clearly, the commentaries on this mystery set the 231 gates as a permutation of pairing each of the 22 letters with each other such as aa, ab, ad, ag, etc. However, this is not a solution since this permutation adds up to 242 not 231. Likewise, the commentary in the William Wynn Westcott edition says, "the number 242 is obtained by adding together all the numbers from 1 to 22. The Hebrew letters can be placed in pairs in 242 different positions." This also is not a solution because the numbers added together equal 253, not 231. Further, Westcott adds, "for the reason why eleven are deducted, and the number 231 specified, see table and note 15 in the edition of Postellus."

This again evades the solution since the year 1552 Latin edition of Gulielmus Postellus resides in the British Museum. Even the volumes of printed rituals of ceremonial magic of the Golden Dawn is silent and never even mentions the 231 gates. If the S.Y. is as ancient as Abraham himself, the good fathers of the Great Lodge have remained silent for some unknown reason.

R.B. Fuller provides the solution on one level of correspondence. On page 62 we discussed the tetractys frequency grid. This showed the underlying order in seemingly random events. The algebraic (B. Fuller's) formula shown as $R = \frac{N^2 - N}{2}$, where N equals the number of events and R the number of relationships between the events.

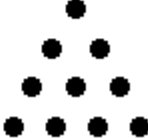
EVENTS	CONNECTIONS	$\frac{N^2 - N}{2}$	CLOSE PACKED
1.			
2.		ONE	
3.		THREE	
4.		SIX	
5.		TEN	

Substituting the number 22 (the number of the Hebrew letters) into our formula we confidently arrive at the number 231, the mystery number of the gates, and as the S.Y. would say about the number of the ten Sephiroth, not one more or one less, but exactly 231.

Thus, the S.Y. explaining the combination of the 22 letters shows the number of communication relationships between the letters, the sum of which is tetrahedral.

On a higher level of correspondence, the mystery of the 231 gates requires a brief journey into mineralogy.

4. The Crystal Space Groups

Crystallography has had a short and concise history. In 1611 J. Kepler published a small pamphlet on hexagonal snow suggesting that the regularity of crystal form is due to the regular geometrical arrangement of small building blocks. In 1669 Nicolas Steno published a theorem that the angles between corresponding faces in crystal structure were constant. In 1780, Carangeat invented a device to measure the Steno interfacial angles. In 1784 the Abbe Havy published an essay on a theory of crystal structure wherein, like Kepler, all crystals are composed of small polyhedral units, the unit for each mineral having a characteristic shape. Later in 1850, M.A. Bravais discovered that 14 types of regular geometrical patterns result from arranging identical points in space, so that any point is repeated at regular intervals along each row of the pattern. These 14 geometric arrangements of unit cells called Bravais lattices as shown in Plat No..

When arranged into groups of symmetry, there are 32 crystal classes and the Law of Seven works into these 32 classes creating seven crystal systems or general crystal groups into which all 32 classes have common elements. Plat No. shows examples of the most common crystal form of each system.

In the late 19th century, in three different locations, three different persons independently developed the geometrical concept of the number of different kinds of arrangement possible in crystal systems.

The first was Leonhard Sohncke (b. 1842) a German professor of physics who combined the fourteen possible space lattice types with the symmetry inherent in the 32 crystal classes and added to it translational motion (screw axis and glide planes). He discovered the concept of space groups. Each of the 32 crystal classes is characterized by symmetry elements that pass through a single point, thus they are now called point groups. However, if each point group is moved through space by translational motion, the result is a geometrical array of scaffolding with symmetry elements grouped into what is called space groups.

In 1879 (the beginning of the reign of St. Michael) Sohncke published the first crystallographic work identifying a total of 65 such space groups. About the same time, E. S. Fedorov a Russian crystallographer and mineralogist published in 1885 the results of his efforts. Likewise, in 1891 Arthur Schoenflies a German mathematician published the result of his research and in 1894 William Barlow an English amateur published his efforts. Although the last three publications arrived independently and from different scientific approaches, they arrived at the same result, to the 65 space groups proposed by Sohncke could be added an additional 165 for a total of 230.

Thus, the combination of the 32 crystal classes with the 14 Bravais space lattices produces 230 possible distributions that atoms can assume in minerals. While, the number of combinations of atoms and molecules is infinite, the number of their arrangements in three-dimensional space or form is limited to 230.

In conclusion, modern era classification of crystalline structure is as follows:

CRYSTAL SYSTEM	# CRYSTAL CLASSES	# SPACE GROUPS
1. Triclinic	2	2
2. Monoclinic	3	13
3. Orthorhombic	3	59
4. Tetragonal	7	68
5. Hexagonal (3-fold)	5	25
6. Hexagonal (6-fold)	7	27
7. Isometric	5	36
Total=	32	230

5. The Mineral Kingdom

There is an occult correspondence between the 231 gates and the 230 crystal space groups. To develop this we return to page

55 where in the seven conditions of life or rounds are briefly described. Here we see that after the 1st - 2nd - 3rd elementary kingdoms, the conditions of life proceeds through the mineral kingdom, plant kingdom, animal kingdom and lastly, the human kingdom. It is important to realize from this evolution that we as humans are in the present mineral kingdom, and not the human kingdom, which is the last of the evolutionary kingdom. Each of the seven conditions of consciousness (manvantara) passes through 49 conditions of life (rounds) for a total of 7 x 49 or 343. To date, we have passed through a total of 171 conditions of form (globes). When evolution proceeds through the remaining 172 conditions of form, mankind will pass into the next higher Jupiter condition consciousness wherein humanity will have evolved into the plant kingdom. In this future condition, a portion of humanity will have angelic bodies and will regulate the plant kingdom as is now accomplished by the present angelic community of spirits ruling from Lower Devachan.

Now, what does this mean that humanity is in the mineral kingdom and not in the human kingdom? Steiner explains the mystery in the lecture series entitled, The Apocalypse of St. John.

"In the earlier period of the Earth's evolution, the mineral kingdom existed in the condition of the (three) elementary kingdoms...It is as if these elementary kingdoms had condensed and disappeared, so to speak, into our world. They precede our mineral kingdoms."

Thus, in one sense fine atomic and sub-atomic substance of the three elementary kingdoms have passed into and created the mineral kingdom. In another sense, man's ego-consciousness is at the level of the mineral kingdom and has not yet evolved into the higher kingdoms. Again,

"What can man comprehend today? He can only understand the mineral kingdom. As soon as he comes to the plant kingdom, he no longer understands it. The mineral kingdom he can understand. From the forces of the mineral kingdom he can construct houses, machines, and so on. When he comes to learn in the same way to observe what the forces are in a plant which make it grow tall, only this will lift him with his consciousness into the plant kingdom.

In time will come when he will take planthood into his own being, just as he now has the mineral kingdom within him. And just as he builds houses of minerals, just as he now uses the forces of the mineral kingdom, so he will in the future, out of the familiar forces of the plant kingdom, produce plant forces and still higher things in the

laboratory, without resorting to seeds...Man will then have risen into the plant kingdom when he understands the plant nature as he now understands the mineral...

Elsewhere, Steiner says,

"The mineral kingdom came into existence during the fourth round. Everything that man does today, the entire world of industry, is the transformation of the mineral kingdom...The whole mineral kingdom will be transformed by man. Here man will work right into the molecules and atoms. Eventually there will be no single atom on earth that has not been worked upon by man. At the end of the fourth round he will have transformed the entire mineral kingdom. From the fifth round onwards man will do the same with the plant kingdom."

The key here is that "at the present time man is perfected alone in the mineral kingdom". When these words were first spoken in 1908, the meaning was less than obvious. Now, at the end of the 20th century, its meaning is crystal clear. Man is building skyscrapers; rubies and emeralds are synthesized in the laboratory; man made ceramics are approaching the perfect super-conductors and silicon valley is the Tower of Babel of synthetic quartz. In fact, we now see the rudiments of the beginning of our consciousness in the plant world with DNA genetically engineered bacteria.

How was this perfection in the mineral world accomplished? It was accomplished by the identity of the 230 crystal space groups, beginning in 1879, the commencement of the Michael Age. Each possible crystal form of the mineral world has now been identified and catalogued by our rational mathematical mind descended from Abraham. With identification comes control of synthesis and reproduction of the mineral elements.

This event of perfection in the mineral kingdom was foreseen by the wisdom of the sun oracle, Malek-Zadek and prophetically given to Abraham in the 231 gates of the S.Y. When Abraham speaks of the 231 gates as the foundation of all things, he speaks of the foundation of all things in the present mineral kingdom. The 231 gates are the 230 crystal space groups. The foundation of all things in the mineral kingdom - minus one. The remaining task of our mineralogist's is to identify that last 231st space group, not yet discovered.

This task is similar to the Greek mathematician who discovered the Archimedean semi-regular solids, including the cuboctahedron, but never realized the spiritual significance of this discovery until two millennium later, R.B. Fuller identifies the cuboctahedron as the "divine" equilibrium form of the cosmos.

Finally, R. Steiner's symbol for the three remaining kingdoms is the cross. The mineral kingdom is excluded because man already controls this kingdom. The lower beam corresponds to the plant kingdom, with its roots buried in the earth and its stem directed upwards. The middle beam corresponds to the animal kingdom, which is a plant turned halfway and carrying its spine horizontally to the earth. The upper beam corresponds to man which is the plant turned upside down. In the plant the sex organs are turned upward in the blossom. In man, the sex organs are turned away and the head is directed upwards. This occult symbol of the cross shows us how man in his evolution must pass through the remaining three kingdoms of nature.

6. Here is Wisdom

"Here is Wisdom", he that can name, number and measure all things under the sun is the hierophant that is the measure of all things. As Dr. Steiner said,

"Just as we place images, Imaginations, before the soul, so on still higher levels the inner power of numbers is placed before human beings. Human beings have to learn to experience the inner proportions of numbers as spiritual music. Of particular importance, however, is the proportion 1:3:7:12. If you understand the proportion of these numbers as a musical relationship in the sense that one number oscillates three times in a given period, another seven, and still another one twelve, then you will find expressed in these numbers the relationship in spiritual music of the 'I', astral body, etheric body and physical body."

This book has been an exercise in understanding and experiencing the inner power of the laws of the numbers 1-3-7-12, numbers which even Steiner says are the most important. This last secret is expressed in this relationship:

I (ego/self)	1	Monadic self
Astral Body	3	Thought and Word
Etheric body	7	Feeling and Imagination
Physical body	12	Will and Action

In addition, our Anonymous author of the MEDITATIONS concurs with this conclusion and says,

"For twelve is the number of modalities of the will and its action; seven is the number of basic modalities of feeling and imagination; three is the numerical law of thought and word; and one, lastly, is the number of the self who thinks, feels and wills. The monad therefore reveals itself through the Trinity underlying thought and word, through the septenary underlying feeling and imagination and through the duodenary underlying will and action.

"The sum of the numbers of reality-1,3,7 and 12-is twenty-two (and not 23, since One transcends the other and includes them itself). This is the true reason for the fact that there are 22 Major Arcana of the Tarot, and no more or

no less...The sacred name JHVH comprises four members or numbers: 1,3,7 and 12...Twenty two is four and four is three revealing one."

The Holy Books of the 22 numbers are the Chaldean Book of Numbers, the Sepher Yetzirah, the Apocalypse of St. John and the Tarot cards of the Major Arcana, which follow Hermeticism thru respectively, the second, third, fourth and fifth cultural epochs. Each is an incarnation of the earlier, but on a higher level. Each is the collection of thoughts of living angels connected in a living tradition and community of spirits from age to age.